



### **For customers in the USA**

This equipment has been tested and found to comply with the limits for a Class A digital device, pursuant to Part 15 of the FCC Rules. These limits are designed to provide reasonable protection against harmful interference when the equipment is operated in a commercial environment. This equipment generates, uses, and can radiate radio frequency energy and, if not installed and used in accordance with the instruction manual, may cause harmful interference to radio communications. Operation of this equipment in a residential area is likely to cause harmful interference in which case the user will be required to correct the interference at his own expense.

You are cautioned that any changes or modifications not expressly approved in this manual could void your authority to operate this equipment.

The shielded interface cable recommended in this manual must be used with this equipment in order to comply with the limits for a computing device pursuant to Subpart J of Part 15 of FCC Rules.

### **Export compliance**

The pylon Camera Software Suite is not listed on the U.S. Commerce Control List (CCL) and does not require a license to be exported or re-exported. It does not have a specific export control classification number (ECCN) and is therefore designated as EAR99.

### **For customers in Canada**

This apparatus complies with the Class A limits for radio noise emissions set out in Radio Interference Regulations.

### **Pour utilisateurs au Canada**

Cet appareil est conforme aux normes Classe A pour bruits radioélectriques, spécifiées dans le Règlement sur le brouillage radioélectrique.

### **Life support applications**

These products are not designed for use in life support appliances, devices, or systems where malfunction of these products can reasonably be expected to result in personal injury. Basler customers using or selling these products for use in such applications do so at their own risk and agree to fully indemnify Basler for any damages resulting from such improper use or sale.

## **Warranty Information**

To ensure that your warranty remains in force, adhere to the following guidelines:

### **Do not remove the camera's product label or serial number label**

If the label is removed and the serial number can't be read from the camera's registers, the warranty is void.

### **Do not open the camera housing or remove the camera front**

Do not open the housing. Touching internal components may damage them. If you are using a dart S-mount or a dart CS-mount camera, do not remove the camera front. The camera front and the circuit board are firmly riveted. Both parts can be damaged if you remove the camera front.

### **Prevent ingress or insertion of foreign substances**

Prevent liquid, flammable, or metallic substances from entering the camera housing or get in contact with the camera board. If operated with any foreign substances inside, the camera may fail or cause a fire.

### **Avoid electromagnetic fields**

Do not operate the camera in the vicinity of strong electromagnetic fields. Avoid electrostatic charging.

### **Transport in original packaging**

Transport and store the camera in its original packaging only. Do not discard the packaging.

### **Clean with care**

Avoid cleaning the sensor if possible. If you must clean it, follow the guidelines in the camera user's manual.

### **Read the manual**

Read the manual carefully before using the camera.

**All material in this publication is subject to change without notice and is copyright Basler AG.**

## **Contacting Basler Support Worldwide**

### **Europe, Middle East, Africa**

Basler AG  
An der Strusbek 60–62  
22926 Ahrensburg  
Germany

Tel. +49 4102 463 515  
Fax +49 4102 463 599

[support.europe@baslerweb.com](mailto:support.europe@baslerweb.com)

### **The Americas**

Basler, Inc.  
855 Springdale Drive, Suite 203  
Exton, PA 19341  
USA

Tel. +1 610 280 0171  
Fax +1 610 280 7608

[support.usa@baslerweb.com](mailto:support.usa@baslerweb.com)

### **Asia-Pacific**

Basler Asia Pte. Ltd.  
35 Marsiling Industrial Estate Road 3  
#05–06  
Singapore 739257

Tel. +65 6367 1355  
Fax +65 6367 1255

[support.asia@baslerweb.com](mailto:support.asia@baslerweb.com)

[www.baslerweb.com](http://www.baslerweb.com)

## Table of Contents

<b>1</b>	<b>Introduction</b>	<b>1</b>
1.1	pylon API Licensing Information	2
<b>2</b>	<b>Precautions</b>	<b>3</b>
2.1	Precautions Applicable to Specific Camera Series	3
2.2	Avoiding EMI and ESD Problems	3
<b>3</b>	<b>Installing the Basler pylon Camera Software Suite</b>	<b>4</b>
3.1	System Requirements	4
3.2	Installation	4
<b>4</b>	<b>Installing a GigE Camera</b>	<b>5</b>
4.1	General Considerations	5
4.1.1	Installation Procedure	6
4.1.2	What Happens When Installing a Basler GigE Vision Network Driver	6
4.2	Software Installation	8
4.3	Adjusting the Installation	9
4.3.1	Configuring a Network Adapter Used with the Filter Driver	9
4.3.2	Disabling the Windows Firewall	12
4.3.2.1	Disabling the Windows Firewall via the Traditional Control Panel	12
4.3.2.2	Disabling the Windows Firewall via Advanced Security Settings	14
4.3.2.3	Disabling the Windows Firewall via the netsh Command Line Utility	15
4.4	Hardware Installation	16
4.4.1	Precautions	16
4.4.2	Connectors of GigE Cameras	17
4.4.3	Installation	18
4.5	Network Recommendations	20
4.5.1	Recommended Network Adapters	20
4.5.2	If You Are Using Multiple Network Adapters in a Single Computer	21
4.5.3	Recommended Network Architectures	22
4.6	Camera and Network Adapter IP Configuration	25
4.6.1	Network Adapter IP Behavior	25
4.6.2	Changing a Network Adapter's IP Configuration	27
4.6.2.1	Setting an Adapter to Use a Fixed IP Address	27
4.6.2.2	Setting an Adapter to Use DHCP/ Auto IP (LLA)	30
4.6.2.3	Checking a Network Adapter's IP Address	32
4.6.3	Camera IP Behavior	33
4.6.4	Changing a Camera's IP Configuration	34
4.7	Modifying the Driver Installation	41
4.7.1	Changing the Driver Association for a Compatible GigE Network Adapter	41
4.7.2	Unbinding the Basler Filter Driver from a Network Adapter	42

---

<b>5</b>	<b>Installing a USB 3.0 Camera</b>	<b>43</b>
5.1	General Considerations	43
5.2	USB 3.0 Host Controller Recommendations	44
5.3	Software Installation	44
5.3.1	Installing the Basler pylon Camera Software Suite	44
5.3.2	Installing the Host Controller Driver	44
5.4	Hardware Installation	46
5.4.1	Precautions	46
5.4.2	Connectors of USB 3.0 Cameras	47
5.4.3	Installation	48
5.5	Using the USB Configurator	49
<b>6</b>	<b>Installing a FireWire Camera</b>	<b>52</b>
6.1	General Considerations	52
6.2	Software and Hardware Installation	54
6.2.1	Precautions	54
6.2.2	Installing the Basler pylon Camera Software Suite	54
6.2.3	Associating a FireWire Driver with Your Camera	55
<b>7</b>	<b>Installing a Camera Link Camera</b>	<b>57</b>
7.1	General Considerations	57
7.2	Frame Grabber Preparations	58
7.2.1	Location of the Serial Port File	58
7.2.2	Frame Grabber Camera Files	59
7.3	Hardware Installation	60
7.3.1	Precautions	60
7.3.2	Connectors of Camera Link Cameras	61
7.3.3	Installation	62
7.4	Software Installation	63
7.5	Configuring the Camera Link Serial Port	63
<b>8</b>	<b>Next Steps</b>	<b>67</b>
8.1	Acquiring Your First Images	67
8.2	Learning How to Configure and Optimize Your Camera	69
8.3	Additional Camera Settings	70
<b>9</b>	<b>Uninstalling or Changing the pylon Camera Software Suite</b>	<b>71</b>
	<b>Revision History</b>	<b>72</b>
	<b>Index</b>	<b>78</b>

# 1 Introduction

This document provides the information you will need to install and operate Basler GigE, USB 3.0, Camera Link, and FireWire (IEEE 1394) cameras. The installation of both hardware and the Basler pylon Camera Software Suite for Windows are covered.

Refer to the camera's User Manual for additional important information such as:

- precautions,
- mechanical specifications, including mounting points,
- mechanical stress test results,
- environmental requirements.

If you are using a GigE camera, refer to the camera's User Manual for information about improving your camera's performance in a network and about using multiple cameras.

# 1.1 pylon API Licensing Information

The pylon API is based on the GenApi module of the GenICam™ reference implementation distributed under a modified BSD license and is copyright (c) 2005, Basler Vision Technologies. All rights reserved. Redistribution and use in source and binary forms, without modification, are permitted provided that the following conditions are met:

- Redistributions of the source code must retain the above copyright notice, this list of conditions, and the following disclaimer.
- Redistributions in binary form must reproduce the above copyright notice, this list of conditions, and the following disclaimer in the documentation and/or other materials provided with the distribution.
- Neither the name of the GenICam standard group nor the names of its contributors may be used to endorse or promote products derived from this software without specific prior written permission.

THIS SOFTWARE IS PROVIDED BY THE COPYRIGHT HOLDERS AND CONTRIBUTORS "AS IS" AND ANY EXPRESS OR IMPLIED WARRANTIES, INCLUDING, BUT NOT LIMITED TO, IMPLIED WARRANTIES OF MERCHANTABILITY AND FITNESS FOR A PARTICULAR PURPOSE ARE DISCLAIMED. IN NO EVENT SHALL THE COPYRIGHT OWNER OR CONTRIBUTORS BE HELD LIABLE FOR ANY DIRECT, INDIRECT, INCIDENTAL, SPECIAL, EXEMPLARY, OR CONSEQUENTIAL DAMAGES (INCLUDING, BUT NOT LIMITED TO, PROCUREMENT OF SUBSTITUTE GOODS OR SERVICES; LOSS OF USE, DATA, OR PROFITS; OR BUSINESS INTERRUPTION) HOWEVER CAUSED AND BASED ON ANY THEORY OF LIABILITY, WHETHER IN CONTRACT, STRICT LIABILITY, OR TORT (INCLUDING NEGLIGENCE OR OTHERWISE) ARISING IN ANY WAY OUT OF THE USE OF THIS SOFTWARE, EVEN IF ADVISED OF THE POSSIBILITY OF SUCH DAMAGE.



## 2 Precautions

### 2.1 Precautions Applicable to Specific Camera Series

For precautions applicable to specific camera series, refer to the camera user's manual.

### 2.2 Avoiding EMI and ESD Problems

Excessive electromagnetic interference (EMI) and electrostatic discharge (ESD) can cause problems with your camera such as false triggering or can cause the camera to suddenly stop capturing images. EMI and ESD can also have a negative impact on the quality of the image data transmitted by the camera. To avoid problems with EMI and ESD, you should follow these general guidelines:

- Always use high quality shielded cables. The use of high quality cables is one of the best defenses against EMI and ESD.
- Try to use camera cables that are the correct length and try to run the camera cables and power cables parallel to each other. Avoid coiling camera cables. If the cables are too long, use a meandering path rather than coiling the cables.
- Avoid placing camera cables parallel to wires carrying high-current, switching voltages such as wires supplying stepper motors or electrical devices that employ switching technology. Placing camera cables near to these types of devices can cause problems with the camera.
- Attempt to connect all grounds to a single point, e.g., use a single power outlet for the entire system and connect all grounds to the single outlet. This will help to avoid large ground loops.
- Use a line filter on the main power supply.
- Install the camera and camera cables as far as possible from devices generating sparks. If necessary, use additional shielding.
- Decrease the risk of electrostatic discharge by taking the following measures:
  - Use conductive materials at the point of installation (e.g., floor, workplace).
  - Use suitable clothing (cotton) and shoes.
  - Control the humidity in your environment. Low humidity can cause ESD problems.



The Basler application note *Avoiding EMI and ESD in Basler Camera Installations* (DD000053) provides more detail about avoiding EMI and ESD.

The document can be obtained from the Downloads section of our website:

[www.baslerweb.com](http://www.baslerweb.com)

# 3 Installing the Basler pylon Camera Software Suite

## 3.1 System Requirements

The Basler pylon Camera Software Suite for Windows requires that one of the following operating systems is installed on your computer:

- Windows 7 (32 bit or 64 bit)
- Windows 8 (32 bit or 64 bit)
- Windows 8.1 (32 bit or 64 bit)
- Windows 10 (32 bit or 64 bit)

## 3.2 Installation

### To install the Basler pylon Camera Software Suite:

1. Download the pylon installer (**Basler pylon 5.x.x.xxxx.exe**) from the Basler website: [www.baslerweb.com](http://www.baslerweb.com).
2. Launch the downloaded installer.
3. Follow the instructions on the screen. The installer will guide you through the installation process.  
During installation, you can choose whether to install the software for use with a GigE camera, a USB 3.0 camera, a FireWire camera, or a Camera Link camera.

For more information, see the interface-specific sections of this document:

- GigE cameras: Section 4.2 on [page 8](#)
- USB 3.0 cameras: Section 5.3 on [page 44](#)
- FireWire cameras: Section 6.2 on [page 54](#)
- Camera Link cameras: Section 7.4 on [page 63](#)

# 4 Installing a GigE Camera

## 4.1 General Considerations

The installation procedures assume that you will be making a peer-to-peer connection between your camera and a computer.

Make sure that the following items are available before starting the installation:

- A Basler GigE camera.
- As applicable, a power supply or a GigE power injector:  
Make sure that the power supply meets all of the requirements listed in the Physical Interface section of the camera User's Manual.  
If you want to use Power over Ethernet (PoE) as an alternative for a camera with PoE capability use a GigE power injector.
- As applicable, a C-mount, CS-mount, or an F-mount lens for the camera.  
If you already know what lens you will be using in your actual application, use this lens during the camera installation and setup. If not, Basler suggests using a zoom lens for your initial installation and setup. Contact Basler technical support if you need assistance in determining the best lens for your application. The support contact numbers appear in the title pages of this manual.
- A computer with a GigE network adapter installed. For a list of recommended network adapters, see Section 4.5.1 on [page 20](#). These adapters have been tested with Basler cameras and work well.  
The computer must be equipped with an appropriate operating system. For recommendations, see Section 3.1 on [page 4](#).
- A standard Ethernet patch cable. Basler recommends the use of a category 6 or category 7 cable that has S/STP shielding (two cables if you are using a power injector).

You should perform the software installation procedure first and the hardware installation procedure second.

## 4.1.1 Installation Procedure

Go through the software installation procedure in this manner:

1. Read Section 4.1.2 on [page 6](#).
2. Go to Section 4.2 on [page 8](#) and install the software.
3. Go to Section 4.3 on [page 9](#) and make additional adjustments, if needed.
4. If you will be connecting cameras to more than one network adapter in a single computer, read Section 4.5.2 on [page 21](#).

## 4.1.2 What Happens When Installing a Basler GigE Vision Network Driver

During installation of the Basler pylon Camera Software Suite, Basler network drivers are bound to all network adapters installed in your computer. This applies not only to all network adapters used to connect to cameras, but also to all other network adapters installed in your computer. Often, your computer will have two network adapters installed, with one used to connect to cameras and the other used to connect to a local area network.

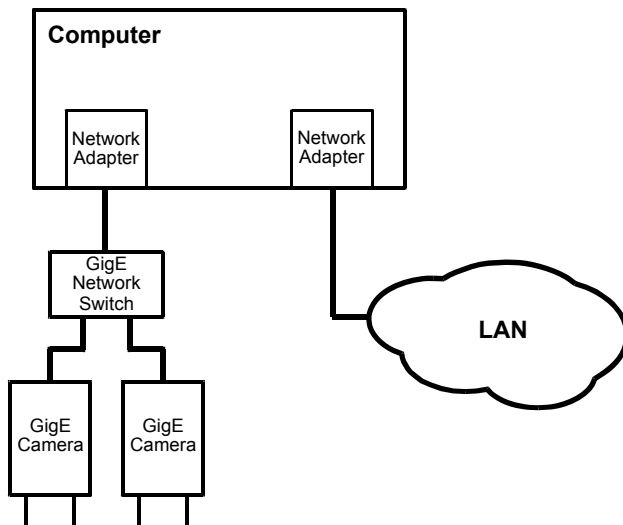

Fig. 1: Network Adapter for the Camera(s)

Two drivers are available for use with your GigE cameras:

- The **Basler filter driver** - is a basic GigE Vision network driver that is compatible with all network adapters. The advantage of the filter driver is its extensive compatibility.
- The **Basler performance driver** - is a hardware-specific GigE Vision network driver. The performance driver is only compatible with network adapters that use specific Intel chipsets ("compatible chipsets"). The advantage of the performance driver is that it significantly lowers the CPU load needed to service the network traffic between the computer and the camera(s). It also has a more robust packet resend mechanism.



If you are using a compatible GigE network adapter, the installation of the Basler pylon Camera Software Suite will remove the driver that is currently installed for the adapter and will install the Basler performance driver. In addition, the Basler filter driver will be bound to the network adapter as a service which, however, will not be enabled.

If you are using a network adapter that requires the filter driver, the installation of the Basler pylon Camera Software Suite will bind the Basler filter driver to the network adapter as a service and will enable the service.

For information about

- reestablishing a previous association with the original driver for a compatible network adapter, see Section 4.7.1 on [page 41](#).
- unbinding the filter driver, see Section 4.7.2 on [page 42](#).
- compatible chipsets, see Section 4.5.3 on [page 22](#).

## 4.2 Software Installation

To install the Basler pylon Camera Software Suite for use with a GigE camera, follow the instructions in Chapter 3 on [page 4](#).

When installing the software, consider the following:

- After installation, Basler recommends unbinding the filter driver from network adapters not used with a camera or used with the performance driver. For more information, see Section 4.7.2 on [page 42](#).
- **GigE Vision Performance Driver:**
  - During installation of the Basler pylon GigE Vision performance driver, **all** current associations in your computer between network drivers and compatible GigE network adapters will be changed, with the performance driver replacing the current drivers.
  - If you want to reestablish the original association between network adapter and driver for a compatible GigE network adapter, see Section 4.7.1 on [page 41](#).
- **GigE Vision Filter Driver:**
  - Make sure to configure the network adapter to be used with the Basler filter driver as described in Section 4.3.1 on [page 9](#).
  - If you are using multiple adapters, you must configure each network adapter to be used with the Basler filter driver individually.

## 4.3 Adjusting the Installation

This section informs about adjustments that must be made after the installation of the Basler pylon Camera Software Suite and about additional adjustments that may be needed.

### 4.3.1 Configuring a Network Adapter Used with the Filter Driver

The following procedures assume that the Basler filter driver was installed on your computer during Installation of the Basler pylon Camera Software Suite or as an individual software feature. After the installation, the settings of each network adapter used with the filter driver must be checked and adjusted, if necessary.

The configuration will generally be used for Fast Ethernet network adapters and network adapters that are not recommended by Basler. They can only be used with the filter driver and not with the performance driver.

Compatible network adapters must also be configured if used with the filter driver. However, Basler strongly recommends using the performance driver for compatible network adapters. These don't need to be configured if used with the performance driver.

#### To modify the network connections:

1. Open the **Network Connections** window in the Windows Control Panel. For quick access, press the Windows + **R** keys, enter `ncpa.cpl` and press the **Enter** key.
2. Find the connection for your network adapter that is used with cameras. Make sure that the window is set to display details (right click within the window, select **View**, and select **Details**).  
If you have multiple GigE adapters that should be used with the filter driver, select any one of them.
3. Right click on the name of the connection and select **Properties** from the context menu.

4. A ... **Properties** window will open as shown below.

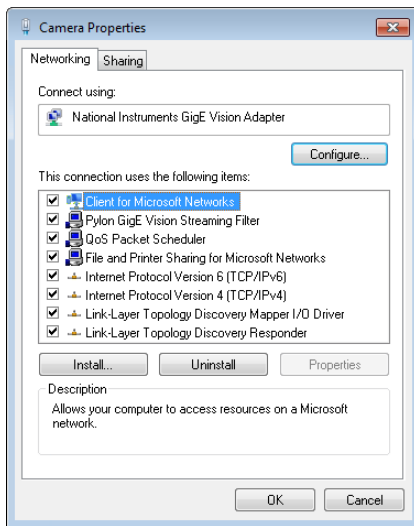

5. Look at the list of items in the center of the ... **Properties** window.
- Make sure that the **Pylon GigE Vision Streaming Filter** and the **Internet Protocol Version 4 (TCP/IPv4)** items are checked as shown below.
  - If the adapter should be used exclusively for cameras, make sure that all of the other items in the list are unchecked. (You may need to scroll the list up or down to see all of the items.)
  - Click the **OK** button to close the ... **Properties** window.

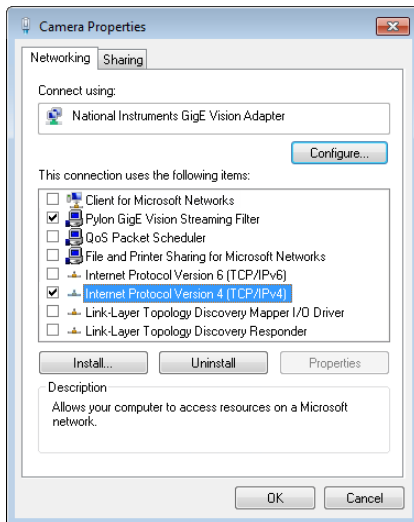

6. If you have only one network adapter in the computer, the configuration for the filter driver is complete and you can close the **Network Connections** window and exit this procedure.

If you have more than one network adapter that should be used with the filter driver, return to step 2, select one of the other adapters, and perform steps 3 through 5 for each adapter.



**To modify the network adapter:**

1. Open the **Network Connections** window in the Windows Control Panel. For quick access, press the Windows + R keys, enter `ncpa.cpl` and press the **Enter** key.
2. Right click on the name of the connection for your network adapter, and select **Properties** from the context menu.
3. Click the **Configure...** button.  
A controller properties window will open.
4. Click on the **Advanced** tab. Select the following parameters in the **Property** group and set their values in the **Value** group:

**Note:** Depending on the network adapter model, the parameter names of your network adapter may differ from the ones shown below. Also, the ways of setting the parameters may differ, and some parameters may not be available.

Contact Basler technical support if you need assistance.

- a. Select the **Jumbo Frames** (or **Jumbo Packets**) parameter and set its size to the maximum value.
  - b. If no **Jumbo Frames** parameter is present, select the parameter which relates to frame size and set its size to the maximum value, which typically is 1.5 kB.
  - c. Select the parameter which relates to the number of receive descriptors (e.g. **Receive Descriptors**) and set it to its maximum value.
  - d. Select the parameter which relates to the number of CPU interrupts (e.g. **Interrupt Moderation Rate**) and set it to a low value (e.g. 1000).  
For your network adapter, the way of setting the number of CPU interrupts may differ. You may, e.g., have to use a parameter to set a low number for the interrupt moderation and use a different parameter to enable the interrupt moderation.
  - e. Select the parameter which relates to speed and duplex mode (e.g. **Speed and Duplex Mode**) and set it to auto (e.g. **Auto Negotiation**).
5. If you have only one network adapter in the computer, the configuration for the filter driver is complete and you can close the **Network Connections** window and exit this procedure.

If you have more than one network adapter that should be used with the filter driver, return to step 2, select one of the other adapters, and perform steps 3 through 5 for each adapter.

Refer to the "Network Related Camera Parameters and Managing Bandwidth" section of your camera User's Manual for further adjustments of the network performance by setting additional network parameters for the network switch and the camera.



If you use a firewall on your computer, disable the firewall for the network adapter to which your camera is connected. For more information about disabling the firewall for network adapters, see [Section 4.3.2](#).

## 4.3.2 Disabling the Windows Firewall

The Basler pylon software requires the Windows firewall to be disabled for all interfaces where cameras are connected, with the exception indicated below.



You do not necessarily need to disable the Windows firewall.

If you leave the firewall enabled, the camera can be fully used with the exception of the event reporting feature. You must only disable the firewall if you want to preserve the possibility of receiving events from the camera.

However, you will have to respond to cumbersome messages when not disabling the firewall: Whenever a program addresses a camera for the first time, a **Windows Security Alert** will open asking you to allow incoming requests. In these cases, click **Cancel** to block each message.

Basler recommends disabling the firewall for the connections with the cameras.



Microsoft provides several ways for configuring the Windows firewall:

- **The traditional control panel**  
This is a relatively simple firewall configuration tool only allowing overall disabling of the firewall.
- **The configuration via advanced security settings**  
These settings are more for a technically-inclined user. The user interface provides very granular firewall configuration options allowing disabling of the firewall for selected connections.  
The management interface can be found in the following way:  
press the Windows + **R** keys > enter `WF.msc`.
- **The netsh command line utility**

### 4.3.2.1 Disabling the Windows Firewall via the Traditional Control Panel

1. Open the Windows Firewall window:
  - Windows 7: Click **Start > Control Panel > System and Security > Windows Firewall**.
  - Windows 8 or higher: Right-click on the bottom-left corner of the screen, then click **Control Panel > System and Security > Windows Firewall**.
2. In the left pane, click **Turn Windows Firewall on or off**.
3. In the **Customize Settings** window, click on **Turn off Windows Firewall (not recommended)** for the network location section where you want to disable firewall protection.

You will typically disable firewall protection for the **Public network location** when a camera is directly connected to the network interface. However, if you use a dedicated network card, Basler recommends also disabling firewall protection for all other network locations.

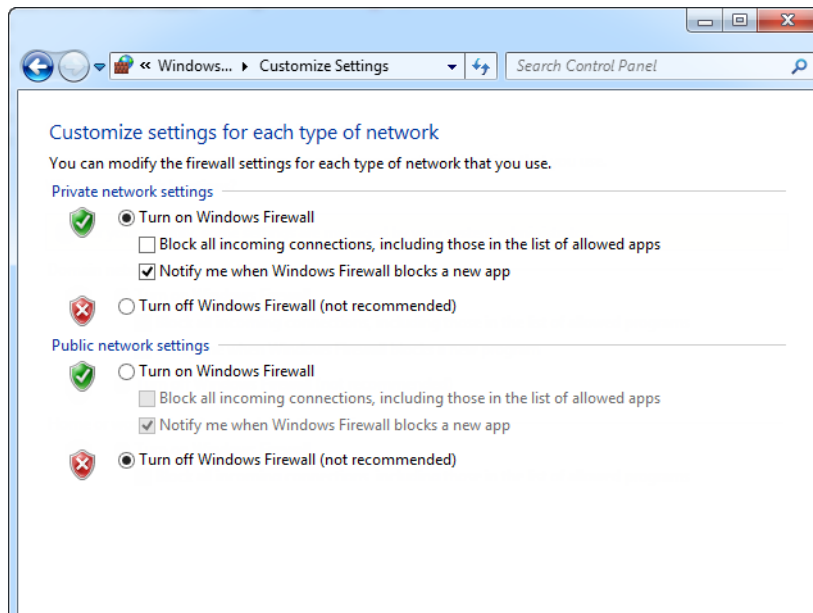

### 4.3.2.2 Disabling the Windows Firewall via Advanced Security Settings

1. Open the **Windows Firewall with Advanced Security** window:

- Press the Windows key + **R** key to open the **Run** window.
- Enter **wf.msc** in the **Open** field.
- Click on **OK**.

The **Windows Firewall with Advanced Security** window opens.

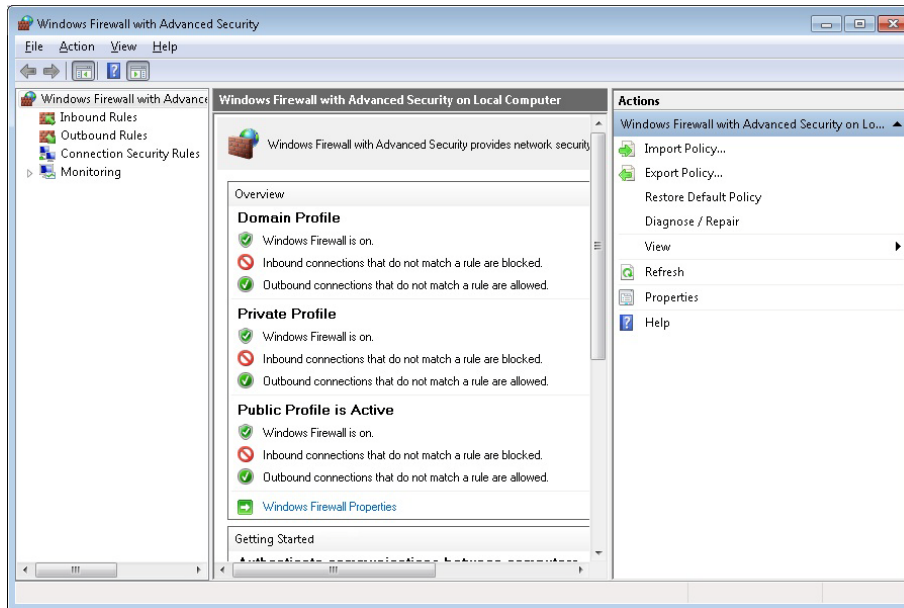

2. In the central pane, at the bottom of the **Overview** group: Click **Windows Firewall Properties** to open the **Windows Firewall with Advanced Security on Local Computer Properties...** window.

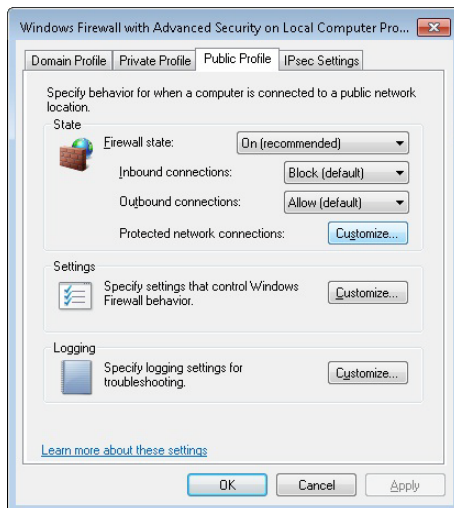

3. Select the tab for the profile where you want to disable firewall protection.

You will typically disable firewall protection for the **Public Profile** when a camera is directly connected to the network interface.

However, if you use a dedicated network card, Basler recommends also disabling firewall protection for all other profiles.

4. Select the **Public Profile** tab.
5. Click **Customize** in the **State** group.

The **Protected Network Connections for the Public Profile** window opens listing connections where a firewall is enabled.

6. Uncheck the connections where cameras are attached to disable their firewall protections. In the figure below, the firewall is disabled for **Local Area Connection 2** as an example.

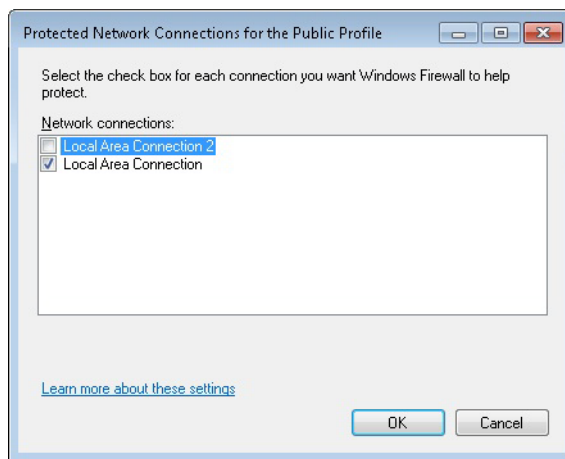

7. Click **OK**.
8. If you use a dedicated network card, also select the other tabs of in the **Windows Firewall with Advanced Security on Local Computer Properties...** window and carry out steps 6 and 7 for each tab.
9. Click **OK** in the **Windows Firewall with Advanced Security on Local Computer Properties...** window.
10. Click **OK** in the **Windows Firewall with Advanced Security** window.

The firewall is disabled where necessary.

### 4.3.2.3 Disabling the Windows Firewall via the netsh Command Line Utility

1. Open the command shell window:
  - Windows 7: Click **Start > All Programs > Accessories**, right click **Command Prompt** and click **Run as administrator** in the context menu. This will run the command shell as an administrator shell.
  - Windows 8 or higher: Right-click on the bottom-left corner of the screen, then click **Command Prompt (Admin)**. This will run the command shell as an administrator shell.
2. Enter `netsh advfirewall set allprofiles state off`
3. Press the **Enter** key.

The firewall is disabled for all profiles. It is not possible to use netsh for disabling the firewall for selected connections only.

## 4.4 Hardware Installation

### 4.4.1 Precautions



**Before installing a Basler GigE camera, read the precautions in the camera user's manual:**

- *ace GigE User's Manual (AW000893)*
- *aviator GigE User's Manual (AW000976)*
- *pilot GigE User's Manual (AW000151)*
- *racer GigE User's Manual (AW001183)*
- *runner GigE User's Manual (AW000493)*
- *scout-g User's Manual (AW000119)*

### 4.4.2 Connectors of GigE Cameras

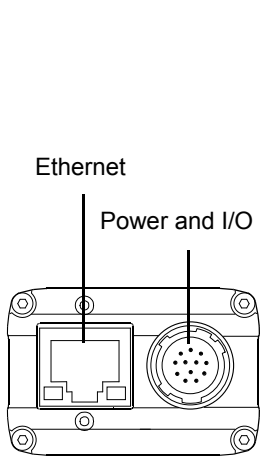

scout and pilot GigE

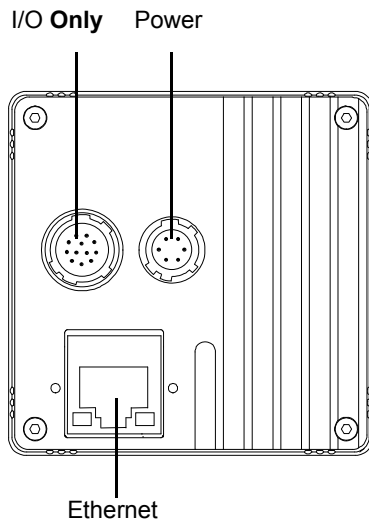

runner GigE

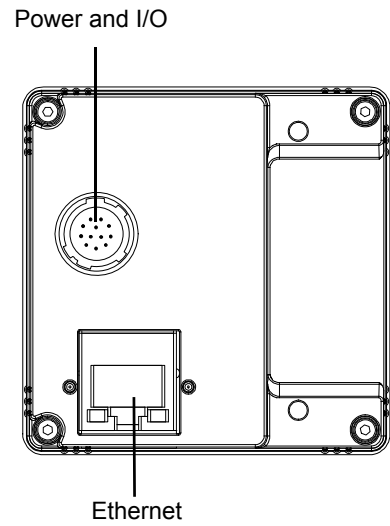

aviator GigE

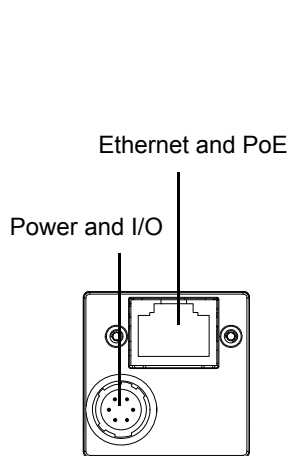

ace GigE

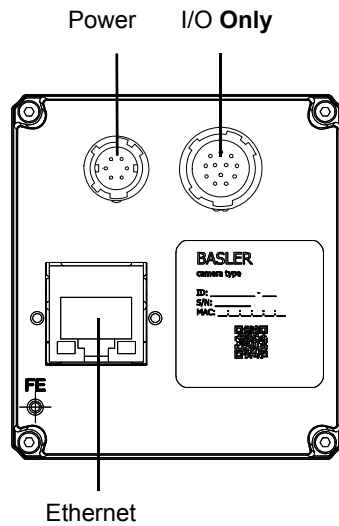

racer GigE

Drawings are not to scale

## 4.4.3 Installation



If you use a firewall on your computer, disable the firewall for the network adapter to which your camera is connected. For more information about disabling the firewall for network adapters, see [Section 4.3.2](#).

### To install the camera hardware:

1. Mount a C-mount, CS-mount or an F-mount lens, as applicable, onto your camera.  
For C-mount and CS-mount lenses, make sure that the lens is screwed into the camera's lens adapter as far as it will go.  
For F-mount lenses, make sure that the lens locks in place when you mount it onto the camera's lens adapter.

2. Connect the camera to the computer and power.

For **ace** cameras if you are using PoE:

- a. Connect one end of a network cable to the network connector of the power injector labeled "Data In" and connect the other end of the cable to the network connector of the GigE network adapter in your computer.
- b. Connect one end of the AC cable for the power injector to the injector's body and the other end to an AC outlet.
- c. Connect one end of a network cable to the network connector of the power injector labeled "PoE Out" and connect the other end of the cable to the network connector of the camera.

For **ace** cameras if you are not using PoE, for **racer** cameras, and for **runner** cameras:

- a. Plug one end of an Ethernet cable into the network adapter in your computer and the other end of the cable into the GigE connector of the camera.
- b. Plug the 6-pin connector of the cable from your power supply into the 6-pin connector of the camera.
- c. Switch on the power supply.

For **aviator**, **pilot**, and **scout** GigE cameras:

- a. Plug one end of an Ethernet cable into the network adapter in your computer and the other end of the cable into the GigE connector of the camera.
- b. Plug the 12-pin output connector from your power supply into the 12-pin connector of the camera.
- c. Switch on the power supply.

The camera will start up and will go through several initialization steps, including e.g. an IP address assignment process. This takes some time.

Once the IP address assignment process is finished, the camera will be ready for use.

If you have your system set so that a network connection icon appears in the system tray, you may see a yellow exclamation point on the icon. You may also see a message about limited connectivity. The message about limited connectivity is normal and this situation will have no effect on the camera. You can ignore this message.





After the camera is powered on, pylon software processes a camera description file included in the camera to make the camera features available for use.

Some camera models include more than one camera description file. The camera description files represent partially different combinations of features (feature sets) and are used alternatively.

To obtain the desired feature set for use you must activate the related camera description file.

If an expected feature is not available after the camera was powered on, activate the camera description file that includes the feature.

Different camera description files require different periods to elapse until the camera features are available for use.

For more information, e.g. about the availability of more than one camera description file for your camera and about activating a camera description file, see the Camera Feature Set section in the camera User's Manual.

## 4.5 Network Recommendations

This section describes the recommended adapters and architectures for the network to which your cameras are attached.

### 4.5.1 Recommended Network Adapters

The following network adapters are recommended for use with Basler GigE cameras:

- Intel Pro 1000 series
- Intel i210 series (formerly "Springville")
- Intel i340 series
- Intel i350 series

These adapters generally work well with the Basler performance driver. However, since the Intel Pro 1000 series has changed over the time, it may happen that the Basler performance driver does not support your particular Intel Pro 1000 adapter.

Contact Basler technical support for recommendations of currently available Pro 1000 adapters and for information about compatible chipsets.

#### Network Adapters and the Basler Network Drivers

Although Basler recommends specific adapters with our GigE cameras (see above), the cameras will work with any Fast Ethernet (100 Mbit/s) or Gigabit Ethernet (1000 Mbit/s) compatible network adapter card.

Two Basler network drivers are available, the Basler filter driver and the Basler performance driver.

- If the adapter is an "incompatible" adapter, i.e. the adapter you are using is not a recommended network adapter, you must install the **Basler filter driver**. Your camera will use the filter driver to communicate via the network adapter. The advantage of the filter driver is that it will work with any Fast Ethernet or Gigabit Ethernet compatible adapter. (If you will be using the filter driver with your network adapter, there is no need to install the performance driver.)
- If you are using a "compatible" adapter, i.e. the adapter you are using is a recommended network adapter, you can install the **Basler performance driver**. Your camera will use the performance driver to communicate via the network adapter. The advantage of the performance driver is that it requires significantly less CPU load to service the network communications between your camera and your computer. It also has a more robust packet resend mechanism.

For more information about installing the network drivers, see Section 4.2 on [page 8](#).

## 4.5.2 If You Are Using Multiple Network Adapters in a Single Computer

With a typical installation of GigE cameras, the default network adapter settings will cause each adapter to use some automatic addressing (Auto IP (LLA) or DHCP IP addressing) to assign itself an IP address. If you are using only one network adapter in your host computer, these adapter settings will work correctly with Basler GigE cameras that are set to default (e.g., new cameras coming out of the box).

However, if you have multiple network adapters in your computer and you will be connecting cameras to more than one adapter, this situation will cause a problem. The LLA addressing scheme does not work correctly when it is used on more than one adapter.

The easiest way to avoid this problem when you are doing the initial camera installation and setup of your system is to change the adapter IP configuration settings and the camera IP configuration settings so that the cameras and the adapters will use fixed IP addressing. You should do this after you have completed the pylon software installation and you have followed the hardware installation procedure to connect the cameras to your adapters.

Some conditions must be met for IP addressing:

- If your computer has multiple network adapters, each adapter must be in a different subnet. If the computer has a multiport adapter, each port must be in a different subnet.
- The camera must be in the same subnet as the port to which it is connected.
- The camera must have an IP address that is unique within the network.

These conditions will be met automatically by DHCP/LLA addressing. However, when using fixed and temporary IP addressing, the correct settings must explicitly be made by the user.

For more information about IP addressing and about setting and changing the IP configuration of the cameras and the network adapters, see Section 4.6 on [page 25](#).

## 4.5.3 Recommended Network Architectures

### Peer-to-peer Network Architecture

A strongly recommended network architecture is direct peer-to-peer connection between your cameras and your host computer. As shown in Figure 2, the cameras can be connected to individual gigabit network adapters in the host computer or to a multiport adapter in the computer.

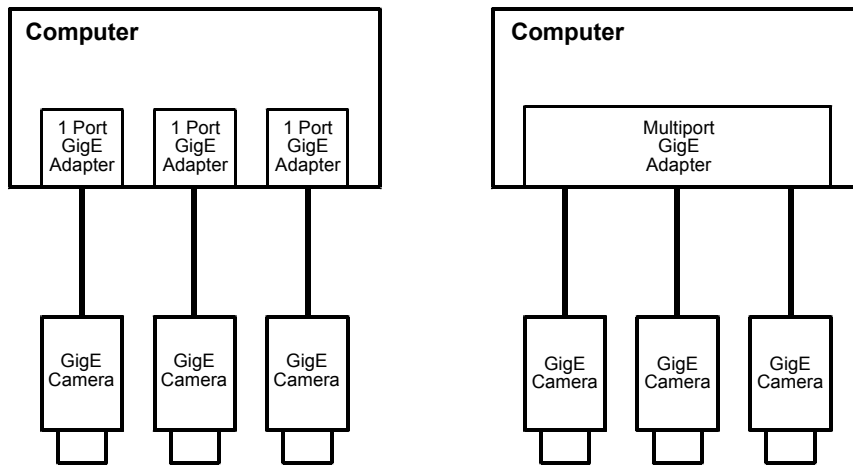

Fig. 2: Peer-to-peer Connections

The main advantage of the direct peer-to-peer architecture is that each camera has an individual connection to the host computer and thus each camera has the full connection bandwidth available for transmitting acquired images. This means that you can operate each camera at its full acquisition rate and not worry about sharing available network bandwidth between cameras.

The disadvantage of the peer-to-peer configuration is that it limits the number of cameras that can be connected to a single computer.

### Connecting Via Network Switches

A second recommended network architecture involves connecting your cameras to the Gigabit Ethernet (GigE) adapter(s) in your host computer via network switches. As shown in Figure 3, the cameras can be connected to individual GigE network adapters in the host computer or to a

multiport adapter in the computer. The figure below only depicts simple schemes for connecting cameras to a computer via network switches.

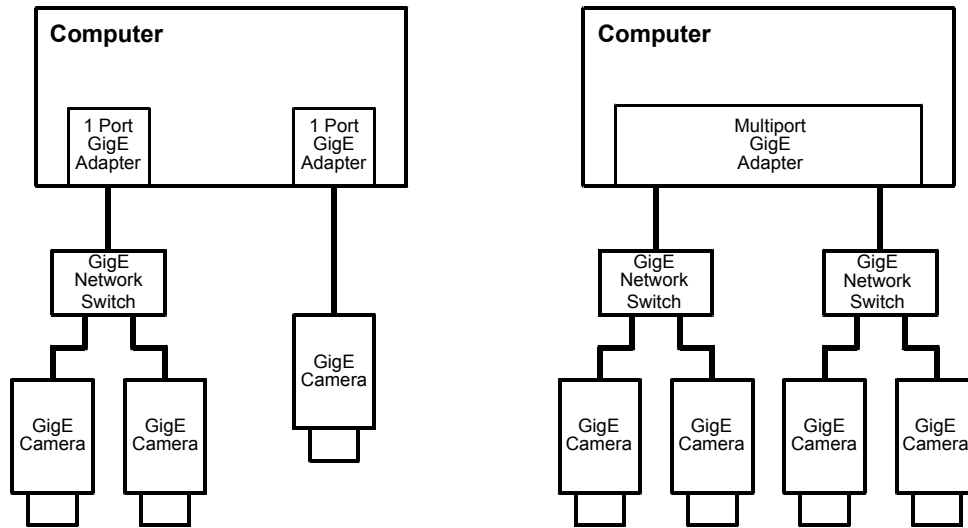

Fig. 3: Network Connections via Switches

One advantage of an architecture using switches is that it allows many cameras to connect to a single host computer. It also allows longer overall cable lengths because the cables between devices can each be up to 100 meters long.

The disadvantage of an architecture using switches is that the data from several cameras can end up passing through a single network connection and thus the cameras must share the bandwidth available on this single path. This situation is illustrated in Figure 4. The four cameras each have a connection to the network switch, but the switch only has a single connection to the computer. The four cameras must share the bandwidth available on the single path between the switch and the adapter. The bandwidth available on this single GigE path is about 125 MByte/s.

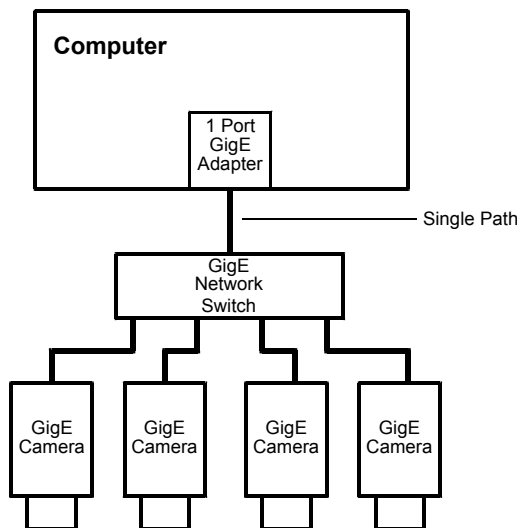

Fig. 4: Multiple Cameras Converging to a Single Path

For more information about managing network bandwidth when using multiple cameras on a single network path, see the "Basler Network Drivers and Parameters" section in the camera User's Manual.

## **Network Switch Issues**

When selecting GigE network switches for use in the type of network described above, there are several issues you must keep in mind.

First is that the switch must be able to handle large packets (also known as "jumbo packets" or "jumbo frames"). The typical maximum packet size on Ethernet devices used in the past was 1.5 kB. With newer "jumbo frame capable" devices, the maximum packet size can be up to 16 kB. Basler GigE cameras and the recommended network adapters (see Section 4.5.1 on [page 20](#)) can both handle jumbo frames. For maximum network efficiency, your camera should be set to use the largest packet size that your network can handle. If you select a network switch that can only handle a small packet size, you will limit network efficiency.

A second issue involving the network switch is buffer capacity. In the situation where multiple cameras are attached to a switch, the switch must have enough buffer capacity to hold the incoming data from the cameras while it transmits the data out in an orderly fashion on the single outgoing line. In general, more buffer capacity is better.

## **Computer Data Bus Issues**

If you are connecting multiple cameras to your host computer, either through direct peer-to-peer connections or through network switches, you must be aware of the data bus type used in the computer. The PCI bus typical of older PCs is theoretically capable of handling 132 MByte/s of data. But in practice, the capacity of the PCI bus is lower and the bus bandwidth is shared by the network adapter and many other devices installed in the computer. To ensure adequate bandwidth on the computer's data bus, use of a computer with a PCI express data bus is recommended.

## 4.6 Camera and Network Adapter IP Configuration

This section describes the default IP configuration for your network adapter and camera. It also describes how to change the IP configuration of your camera and on your network adapter.



This section of the user's manual assumes that you are familiar with basic Ethernet network concepts and with TCP/IP concepts such as IP addresses, subnet masks, and default gateways. If you are not, you should take some time to familiarize yourself with this basic information.

The following website provides comprehensive information about TCP/IP as it applies to Windows operating systems:

<http://technet.microsoft.com/en-US/>

This section also assumes that you are familiar with using basic Windows operating system tools such as the Network Connections window to access your network adapter.

### 4.6.1 Network Adapter IP Behavior

The two most common ways to set the IP configuration of network adapters are:

- to set a fixed address
- to set automatic addressing via DHCP (Dynamic Host Configuration Protocol) or Auto IP (Link Local Address (LLA), also known as Automatic Private IP Addressing (APIPA)).

When an adapter is set for a fixed IP address, it will simply use a fixed address that has been assigned to the adapter by the user.



The terms "static", "fixed" and "persistent" are all used synonymously when talking about IP addresses. They all mean an IP address that will stay in place even when the camera is reset or switched off and back on. In addition, the configuration settings related to this type of IP address are explicitly assigned to the camera by the user.

When an adapter is set for DHCP / Auto IP (LLA), it will do the following:

- It will first attempt to obtain an IP address from a (DHCP) server. If a DHCP server is available, it will obtain an IP address from the server and use it.
- If no DHCP server is available, the adapter will use its alternate configuration. The alternate configuration will be for the adapter to use the LLA routine to assign itself an IP address.

The default setting for most network adapters is DHCP / LLA. In most cases, the adapter used with your cameras will not have a DHCP server available. So with the default settings, the adapter will end up using automatic IP addressing to assign itself an IP address.



There is another adapter IP configuration available called "DHCP / Alternate Configuration = Fixed Address", but this configuration is seldom used.

For more information about the LLA address routine, see Section 4.6.2.2 on [page 30](#).



## 4.6.2 Changing a Network Adapter's IP Configuration

### 4.6.2.1 Setting an Adapter to Use a Fixed IP Address

**To configure a network adapter to use a fixed IP address:**

You can configure a network adapter to use a fixed IP address by doing the following:

1. Open the **Network Connections** window in the Windows Control Panel. For quick access, press the Windows + R keys, enter `ncpa.cpl` and press the **Enter** key.
2. Find the connection for your network adapter that is used with cameras. Make sure that the window is set to display details (right click within the window, select **View**, and select **Details**).
3. Right click on the name of the connection and select **Properties** from the context menu.
4. A ... **Properties** window will open as shown below. Make sure that **Internet Protocol Version 4 (TCP/IPv4)** is highlighted and click the **Properties** button.

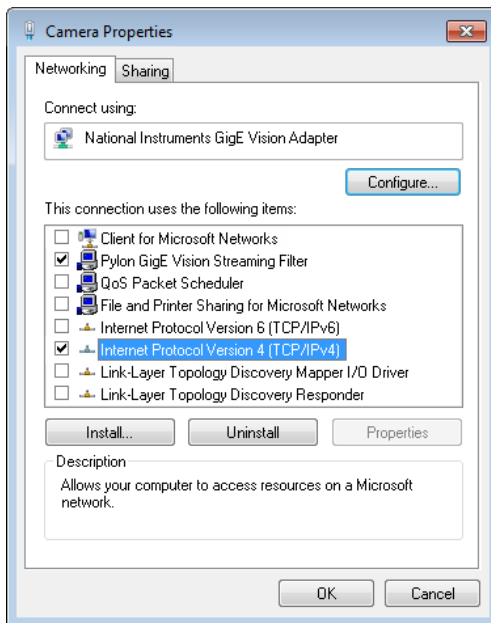

5. An **Internet Protocol Version 4 (TCP/IPv4) Properties** window will open and the **General** tab will be selected as shown below.

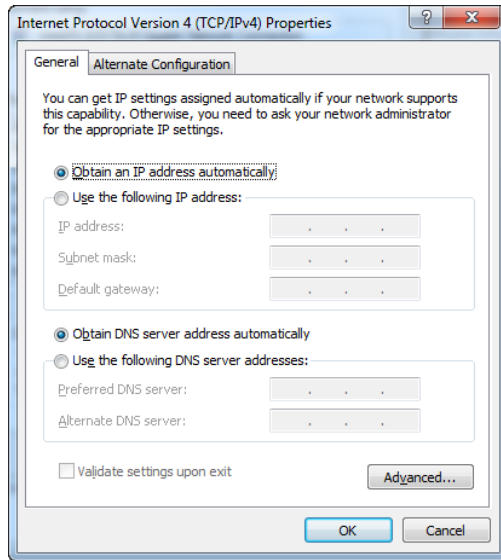

6. Click the radio button next to **Use the following IP address**. The window will change and will now allow you to enter IP address information.
- Enter your desired IP address and subnet mask. The figure below shows the window with typical values entered. You can also enter a default gateway if desired, however, a default gateway is not normally needed.
  - If you will be using a domain name server (DNS), enter the appropriate information. (A domain name server is not normally needed.)
  - Click the **OK** button to close the **Internet Protocol Version 4 (TCP/IPv4) Properties** window.

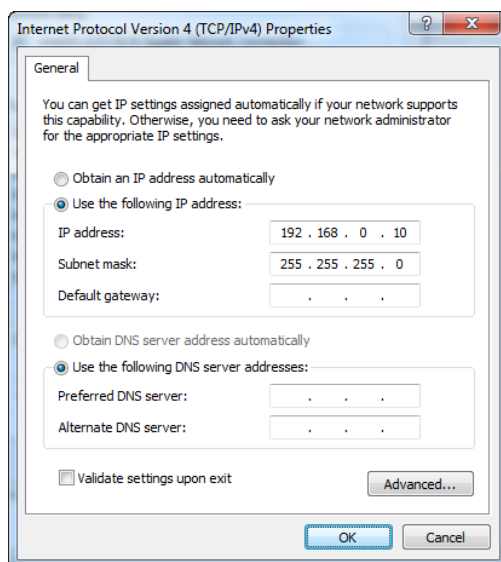

- Click the **OK** button to close the **... Properties** window.



When you configure an adapter to use a fixed address, there are some things that you must keep in mind:

- If your computer has multiple network adapters, each adapter must be in a different subnet.
- The recommended range for fixed IP addresses is from 172.16.0.1 to 172.32.255.254 with a subnet mask of 255.255.0.0 and from 192.168.0.1 to 192.168.255.254 with a subnet mask of 255.255.255.0. These address ranges have been reserved for private use according to IP standards.
- If you are assigning fixed IP addresses to your cameras, keep in mind that for a camera to communicate properly with a network adapter, it must be in the same subnet as the adapter to which it is attached.



There is a convenient "trick" that is handy during your initial camera design-in process or when working with cameras in your lab. You can set your network adapter to a fixed address in the automatic IP address range (169.254.0.1 to 169.254.255.254) with a subnet mask of 255.255.0.0 and you can set your camera(s) for Auto IP (LLA) address assignment.

With these settings, a camera and an adapter can establish a network connection very quickly. This can save you some time if you are connecting and disconnecting cameras or switching the system on and off as you would during design-in.

### 4.6.2.2 Setting an Adapter to Use DHCP/ Auto IP (LLA)

When a network adapter is set for DHCP / Auto IP (LLA), it will first try to find a DHCP server and to obtain an IP address from the server. If no DHCP server is available, the adapter will revert to the "alternate configuration". The alternate configuration will be for the adapter to use its built-in LLA routine to automatically assign itself an IP address.



There is a limitation you must be aware of when setting adapters to use LLA as an alternate configuration. If a computer is equipped with multiple network adapters, LLA can only be used on one of the adapters. If LLA is enabled on more than one adapter, the network will not operate properly.

If your computer is equipped with a multiport network adapter board, each port is considered to be the equivalent of a separate adapter. LLA should be enabled on only one port.

#### To configure a network adapter for DHCP / LLA:

1. Open the **Network Connections** window in the Windows Control Panel. For quick access, press the Windows + **R** keys, enter `ncpa.cpl` and press the **Enter** key.
2. Find the connection for your network adapter that is used with cameras. Make sure that the window is set to display details (right click within the window, select **View**, and select **Details**).
3. Right click on the name of the connection and select **Properties** from the context menu.
4. A ... **Properties** window will open as shown below. Make sure that **Internet Protocol Version 4 (TCP/IPv4)** is highlighted and click the **Properties** button.

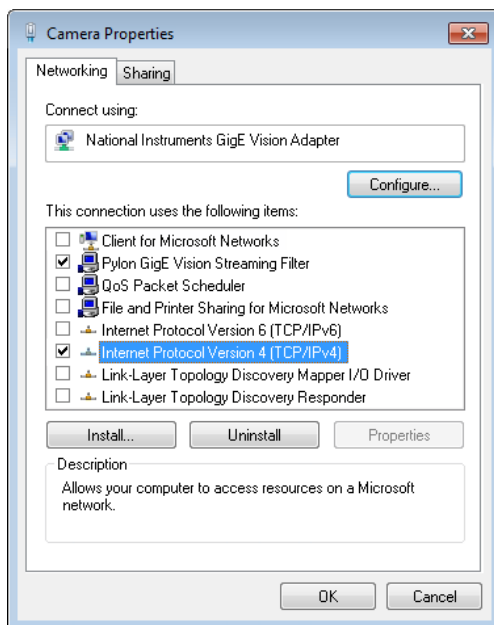

5. An **Internet Protocol Version 4 (TCP/IPv4) Properties** window will open as shown below.
  - a. On the **General** tab, make sure that the **Obtain an IP address automatically** radio button is selected. (This sets the adapter to check for a DHCP server as its first choice.)

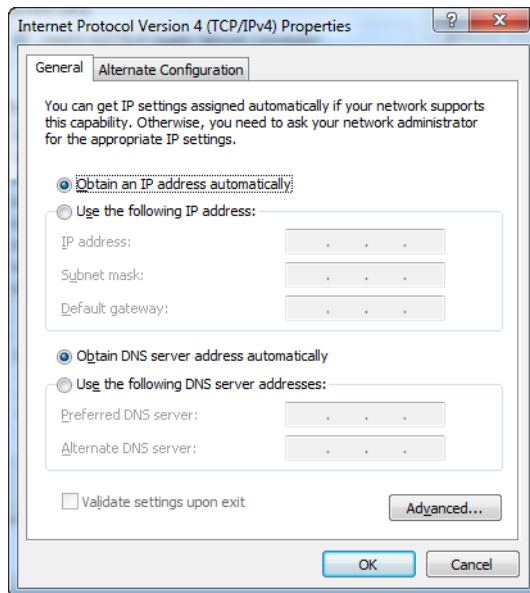

6. Click on the **Alternate Configuration** tab. The settings on this tab are used to set the Auto IP (LLA) address assignment as the alternate configuration that the adapter will use if no DHCP server is found.
  - a. Select the **Automatic private IP address** radio button as shown below.

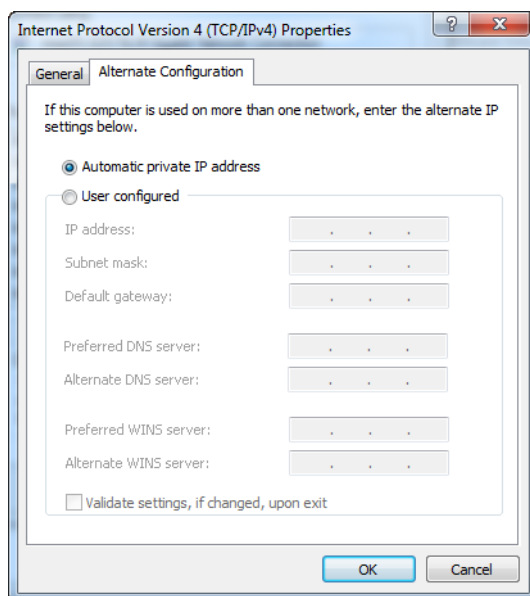

7. Click the **OK** button to close the **Internet Protocol Version 4 (TCP/IPv4) Properties** window.
8. Click the **OK** button to close the **... Properties** window.

### 4.6.2.3 Checking a Network Adapter's IP Address

#### To check the current IP address of a network adapter:

1. Open the **Network Connections** window in the Windows Control Panel. For quick access, press the Windows + **R** keys, enter `ncpa.cpl` and press the **Enter** key.
2. Find the connection for your network adapter that is used with cameras. Make sure that the window is set to display details (right click within the window, select **View**, and select **Details**).
3. Find the connection for the adapter you want to check and make sure that the status of the connection is shown as "connected" (if the status is "disconnected", this procedure will not work). Double-click on the name of the connection.

A **LAN Connection Status** window will open as shown below.

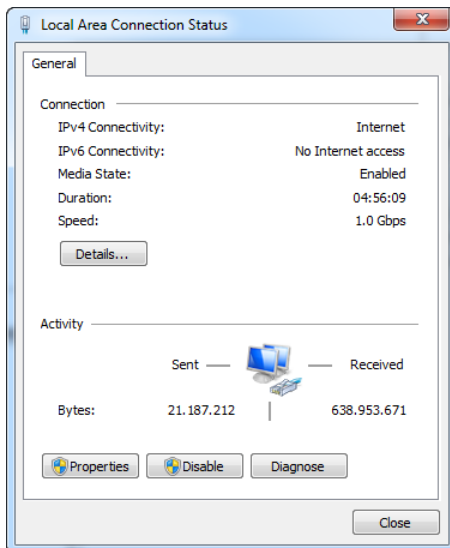

4. Click on **Details...**

The IP address information for the adapter will be displayed as shown below.

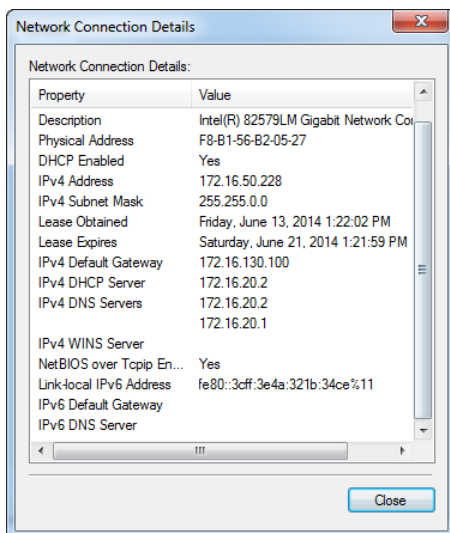

## 4.6.3 Camera IP Behavior

When a camera is powered on or reset, it exhibits the following behavior when it tries to connect to an Ethernet network:

- If the camera has a static IP address configured, it will use this static IP address.
- If the camera is configured to use a Dynamic Host Configuration Protocol (DHCP) server to obtain an IP address and a DHCP server is available, the camera will obtain an IP address from the server. If no DHCP server is available, the camera will assign itself an Auto IP address (see below).
- If the camera has Auto IP (LLA) (also known as Automatic Private IP Addressing (APIPA)) configured, it will assign itself a random IP address in the Auto IP address range 169.254.0.1 to 169.254.255.254.

The default setting of new cameras is to use a DHCP server.



The search for a DHCP server and completion of an Auto IP (LLA) routine can take up to one minute.

### Auto IP (LLA)

The Auto IP (LLA) routine is a network standard that dictates how an IP address will be assigned to a network adapter and to the devices connected to the adapter when no other means of address assignment is available. In essence, the adapter or the device will assign itself an IP address in a range from 169.254.0.1 to 169.254.255.254 with a subnet mask of 255.255.0.0. As part of the routine, the network adapter and the devices attached to the adapter negotiate to make sure that there are no duplicate address assignments and that the adapter and the devices are all on the same subnet.



For Auto IP assignment to work correctly, the network adapter that the camera is plugged into must also be set for Auto IP assignment or it must be set for a static address in the Auto IP address range.



If you have multiple network adapters in your computer, only one adapter can be set to use Auto IP assignment. If more than one adapter is set to use Auto IP assignment, Auto IP assignment will not work correctly and the cameras **will not** be able to connect to the network.

In the case of multiple network adapters, it is best to assign static IP addresses to the adapters and to the cameras. You can also set the cameras and the adapters for DHCP IP addressing and install a DHCP server in your network.

## 4.6.4 Changing a Camera's IP Configuration

An application called the pylon IP Configurator is included as part of the Basler pylon Camera Software Suite. The pylon IP Configurator shows you the current IP configuration of your camera and allows you to change it.

When you start the pylon IP Configurator it scans the computer for network adapters ("connections") and attached cameras. All discovered network adapters and cameras will be displayed in the top pane. Detailed information about the item selected in the top pane will be displayed in the central area below.

Depending on the firmware version of your camera, the process to change the IP configuration can differ. With older cameras, an intermediate step may be necessary in which you assign a temporary IP address in order to establish communication between the camera and the computer. If this is the case, the pylon IP Configurator will automatically open the **Assign Temporary IP Address (Force IP)** dialog. For newer cameras this is not necessary, because they can automatically establish communication with the computer.

During normal operation, you may want to change the camera's IP configuration in e.g. the following typical situations:

- A different way of IP address assignment is desired for operational reasons, e.g. via a DHCP server instead of using a static IP address.
- A temporary IP address has to be assigned when the camera is moved to a different port or network adapter and therefore has to operate in a different subnet.

### pylon IP Configurator

#### To open the pylon IP Configurator:

1. Double-click the **pylon IP Configurator** icon on your desktop.

The following figure shows the pylon IP Configurator when a network adapter is selected.

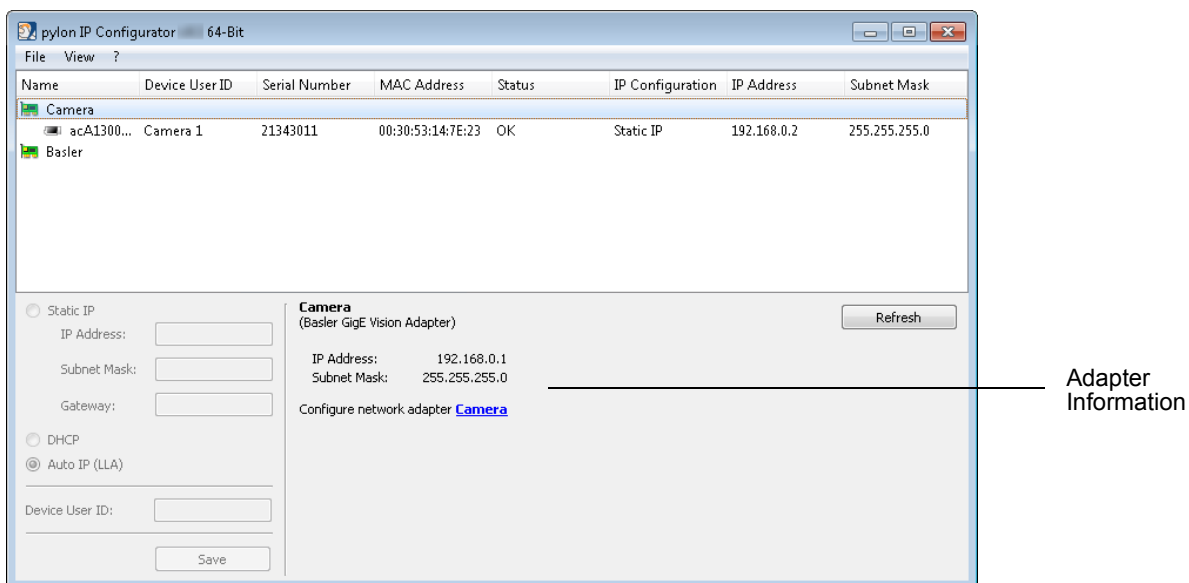



When you select a network adapter, the following adapter information is displayed below the top pane:

- Name of the connection and of the network adapter.
- **IP Address** - The IP address of the network adapter.
- **Subnet Mask** - The subnet mask of the network adapter.

This area also contains a link to the Windows ... **Properties** dialog where you can change the adapter configuration.

To the right of the adapter information is a **Refresh** button. If you click it, the tool will update the displayed network adapter and camera information. This way you can make sure that all of the displayed information is current.

The following figure shows the pylon IP Configurator when a camera is selected.

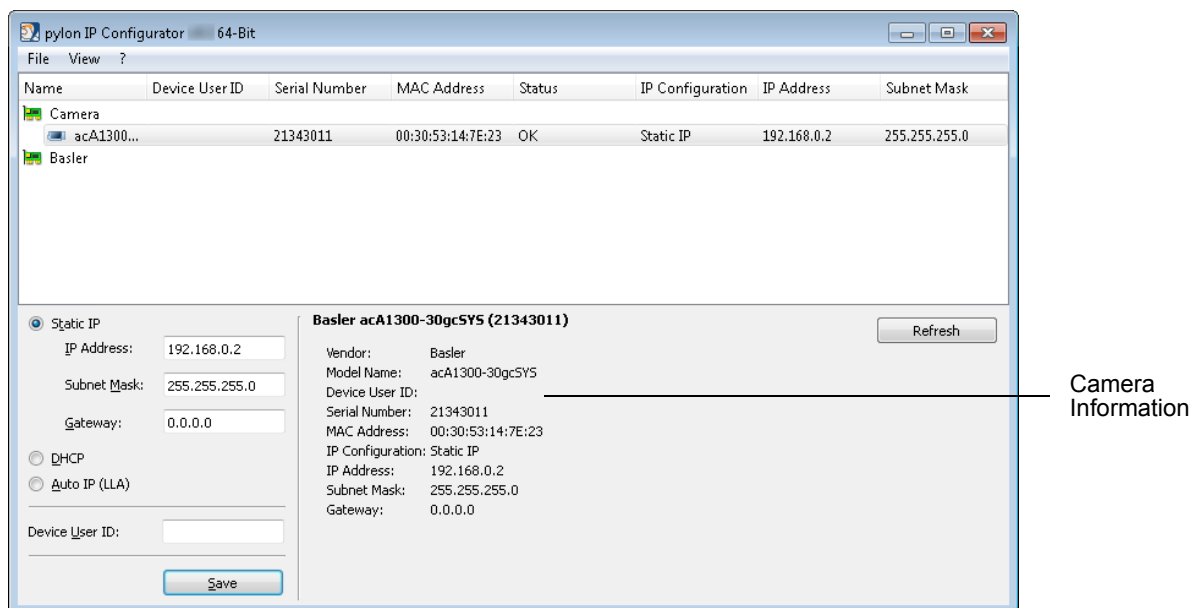

When you select a camera, the following camera information is displayed.

In the top pane:

- **Name** - The name of the camera model.
- **Device User ID** - A user-defined identifier for the camera (if one has been assigned).
- **Serial Number** - The serial number of the camera.
- **MAC Address** - The MAC address of the camera.
- **Status** - The connection status of the camera.
- **IP Configuration** - The method used for assigning the current IP address to the camera.
- **IP Address** - The current IP address of the camera.
- **Subnet Mask** - The subnet mask of the camera.

Below the top pane:

- Name of the camera. - The Device User ID is displayed if one has been assigned. Otherwise, the camera model and serial number are displayed.

- **Vendor** - The name of the camera vendor.
- **Model Name** - The name of the camera model.
- **Device User ID** - A user-defined identifier for the camera (if one has been assigned).
- **Serial Number** - The serial number of the camera.
- **MAC Address** - The MAC address of the camera.
- **IP Configuration** - The method used for assigning the current IP address to the camera.
- **IP Address** - The current IP address of the camera.
- **Subnet Mask** - The subnet mask of the camera.
- **Gateway** - The gateway used by the camera, if applicable.

To the right of the camera information is a **Refresh** button. If you click it, the tool will update the displayed network adapter and camera information. This way you can make sure that all of the displayed information is current.

Hint text is displayed in the lower right area of the window. For example, if a camera is not reachable because of a problem with the IP address, the hint text will tell you how to fix the problem. The following figure shows an example:

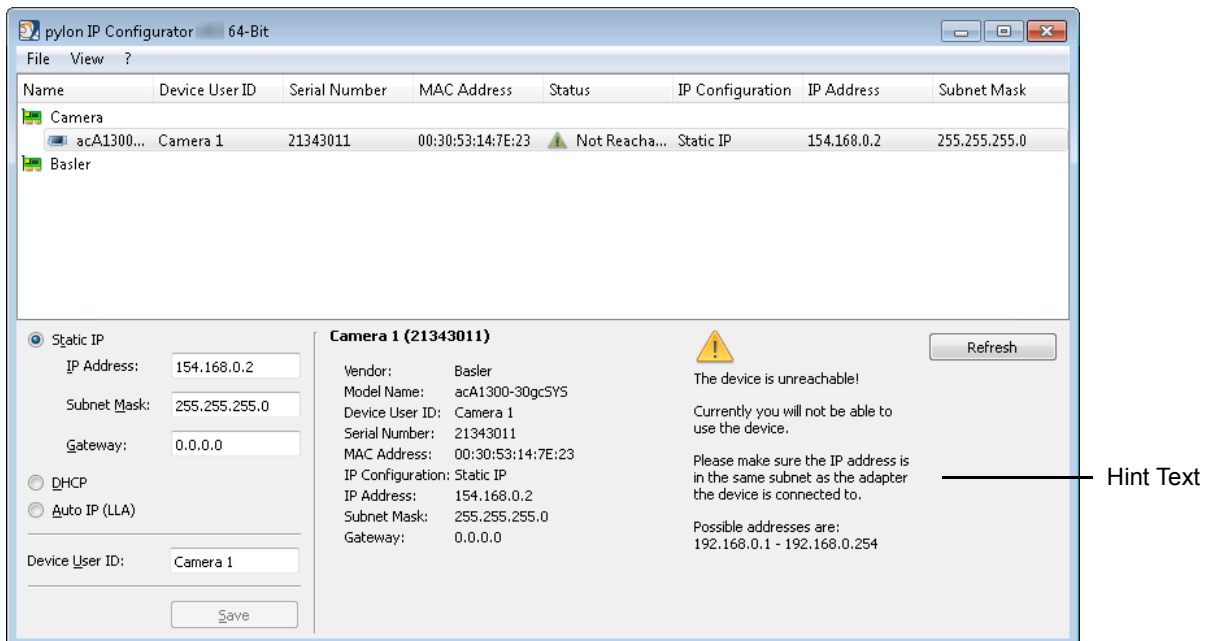

The pane in the lower left area of the window contains controls for changing the IP configuration and the device user ID of the camera. Changing the camera's IP configuration will be explained in the following sections. To change the device user ID of the camera, use the following procedure:

## Setting the Device User ID

### To set the device user ID:

1. Enter a new device user ID for the camera in the **Device User ID** field. You can enter Unicode characters.
2. Click the **Save** button.

The tool will save your changes which takes a few seconds. When the tool has finished saving, the information in the top pane and the lower central area will have been updated automatically.



When you configure a camera to use either a temporary or a static IP address, some requirements must be satisfied for a camera to communicate properly:

- If your computer has multiple network adapters, each adapter must be in a different subnet. If the computer has a multiport adapter, each port must be in a different subnet.
- The camera must be in the same subnet as the port to which it is connected.
- The camera must have an IP address that is unique within the network.
- The recommended range for static IP addresses is from 172.16.0.1 to 172.32.255.254 and from 192.168.0.1 to 192.168.255.254. These address ranges have been reserved for private use according to IP standards.

## Assigning an IP Address to a Camera (Static, Via DHCP, Via LLA (Auto IP))

You can use the pylon IP Configurator to change the current method for assigning an IP address to a camera. These changes will stay in place even when the camera is reset or switched off and back on.

There are the following options:

- **Static IP** - Static IP means that you will assign an IP address is assigned to the camera by you that will stay in place even when the camera is reset or switched off and back on. You may also have to specify a subnet mask and a gateway. Make sure that the camera is in the same subnet as the adapter and that the camera has a unique IP address.
- **DHCP** - DHCP means that a DHCP server assigns an IP address to the camera.
- **Auto IP (LLA)** - Auto IP (Link Local Address) means that the camera uses automatic IP address assignment and assigns itself an IP address.

For more information about the different IP configuration options, see "Network Adapter IP Behavior" on [page 25](#) and "Camera IP Behavior" on [page 33](#).

### To set a camera to a static IP address:

1. In the top pane of the tool, select the camera whose IP configuration you want to change.
2. In the lower left pane of the tool, select **Static IP**.

The fields **IP Address**, **Subnet Mask** and **Gateway** become active. If you are choosing **Static IP** for the first time, the fields are empty. Otherwise, the fields will contain the current values.

3. Enter the desired IP address in the **IP Address** field.

4. Fill in the fields **Subnet Mask** and **Gateway**.
  - a. If you are choosing **Static IP** for the first time, the fields **Subnet Mask** and **Gateway** will be populated automatically when you put the cursor in them.
  - b. If you are changing an existing static IP address, change the current values if required.
5. Click the **Save** button.
  - a. If you have a newer camera, the tool will save your changes which takes a few seconds. When the tool has finished saving, the information in the top pane and the lower central area will have been updated automatically.
  - b. If you have an older camera and the settings made in steps 3 and 4b are not compatible with the IP address configuration of the port or network adapter to which the camera is connected, the **Assign Temporary IP Address (Force IP)** dialog opens. Go to section "Assigning a Temporary IP Address to Older Cameras" on [page 39](#) and follow those steps. Once you have completed that procedure, the settings you have made here will be applied.

#### To set a camera to DHCP Address Assignment:

1. In the top pane of the tool, select the camera whose IP configuration you want to change.
2. In the lower left pane of the tool, select **DHCP**.
3. Click the **Save** button.
  - a. If you have a newer camera, the tool will save your changes which takes a few seconds. When the tool has finished saving, the information in the top pane and the lower central area will have been updated automatically.
  - b. If you have an older camera and the settings made in steps 3 and 4b are not compatible with the IP address configuration of the port or network adapter to which the camera is connected, the **Assign Temporary IP Address (Force IP)** dialog opens. Go to section "Assigning a Temporary IP Address to Older Cameras" on [page 39](#) and follow those steps. Once you have completed that procedure, the settings you have made here will be applied.



If no DHCP server is present or if there is a problem preventing the DHCP server from assigning an IP address to the camera, automatic IP address assignment will be used as a fallback.

#### To set a camera to AUTO IP (LLA):

1. In the top pane of the tool, select the camera whose IP configuration you want to change.
2. In the lower left pane of the tool, select **Auto IP (LLA)**.
3. Click the **Save** button.
  - a. If you have a newer camera, the tool will save your changes which takes a few seconds. When the tool has finished saving, the information in the top pane and the lower central area will have been updated automatically.
  - b. If you have an older camera and the settings made in steps 3 and 4b are not compatible with the IP address configuration of the port or network adapter to which the camera is connected, the **Assign Temporary IP Address (Force IP)** dialog opens. Go to section "Assigning a Temporary IP Address to Older Cameras" on [page 39](#) and follow those steps. Once you have completed that procedure, the settings you have made here will be applied.

## Assigning a Temporary IP Address to a Camera

You can use the pylon IP Configurator to assign a temporary IP address to a selected camera. Once a temporary IP address has been assigned to a camera, the camera will retain and use the temporary IP address until you do one of the following:

- Perform a camera reset or switch the camera off and back on.
- Use the tool to assign a different IP address to the camera.

## Assigning a Temporary IP Address to Older Cameras (Required Assignment)

If the current IP address configuration of older cameras is not compatible with the IP address configuration of the port or network adapter to which the camera is connected, you have to assign a temporary IP address.

If a temporary IP address is necessary, the pylon IP Configurator will automatically open the **Assign Temporary IP Address (Force IP)** dialog.

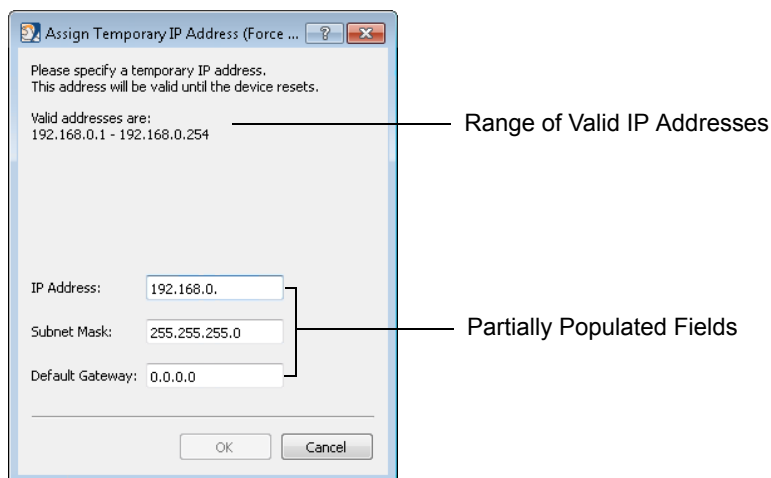

The **Assign Temporary IP Address (Force IP)** dialog contains the fields **IP Address**, **Subnet Mask** and **Default Gateway**. It also displays valid IP address ranges. Depending on the subnet that the camera is in, a partial IP address has already been entered in the **IP Address** field. The fields **Subnet Mask** and **Default Gateway** have also been populated with valid information already. This helps to avoid misconfiguring the new temporary IP address.

## Assigning a Temporary IP Address to Older Cameras

### To assign a temporary IP address to older cameras:

1. In the **Assign Temporary IP Address (Force IP)** dialog, complete the IP address in the **IP Address** field with a value from the range of valid IP addresses.
2. If desired, change the value in the **Subnet Mask** field.
3. If desired, change the value in the **Default Gateway** field.

4. Click the **OK** button.

The tool will save your changes which takes a few seconds. When the tool has finished saving, the information in the top pane and the lower central area will have been updated automatically with the new IP address.

## Assigning a Temporary IP Address to Older or Newer Cameras (Optional Assignment)

Another situation where you might want to assign a temporary IP address to a camera would be if you temporarily moved the camera from the computer where it is normally connected to another computer that is in a different subnet. This can be necessary from time to time regardless of whether you have a newer or an older camera model.

### Assigning a Temporary IP Address to Older Or Newer Cameras:

**To assign a temporary IP address to older or newer cameras:.**

1. Right-click on the camera whose IP configuration you want to change.
2. Choose **Assign Temporary IP Address** from the context menu.

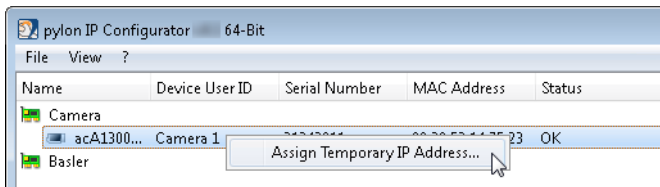

3. Follow the steps described under "Assigning a Temporary IP Address to Older Cameras" on [page 39](#).

## 4.7 Modifying the Driver Installation

### 4.7.1 Changing the Driver Association for a Compatible GigE Network Adapter

During installation of the Basler pylon Camera Software Suite, the current network adapter-driver associations are changed for **all** compatible network drivers installed in your computer. The Basler performance driver will replace the current drivers.

If you want to reestablish a network adapter-driver association with the original driver, follow the procedures below. The procedures describe how to change the driver on a GigE network adapter from the performance driver back to the original driver.

#### To change the driver association:.

1. Open the **Network Connections** window in the Windows Control Panel. For quick access, press the Windows + R keys, enter `ncpa.cpl` and press the **Enter** key.
2. Find the entry for the network adapter whose association you want to change. Make sure that the window is set to display details (right click within the window, select **View**, and select **Details**). When moving the pointer over the name of the network adapter, notice that the tooltip indicates **Basler GigE Vision Adapter**.
3. Right click on the name of the network adapter.
4. Select **Properties** from the context menu. A **LAN Connection Properties** window for the adapter will open.
5. Click the **Configure** button.
6. Select the **Driver** tab.
7. Click the **Update Driver** button.
8. When the hardware wizard opens, click **Browse my computer for driver software**.
9. Click **Let me pick from a list of device drivers on my computer**.
10. From the list that appears, select the original driver for the adapter (e.g., in a case where the Intel Pro 1000 GT Desktop Adapter is installed in the computer, select **Intel Pro 1000 Desktop Adapter** from the list) and click the **Next** button.
11. The system will update the driver. Click the **Close** button.
12. Close the **Properties** window.  
In the **Network Connections** window, notice that the Device Name for the adapter has changed (in the case of the Intel Pro 1000 GT, it will now be **Intel Pro/ 1000 GT Desktop Adapter**).

The network adapter-driver association is changed.

## 4.7.2 Unbinding the Basler Filter Driver from a Network Adapter

During installation of the Basler pylon Camera Software Suite, the Basler filter driver will be bound as a service to **all** network drivers installed in your computer. For Fast Ethernet network adapters and network adapters that are not recommended by Basler, the service will be enabled and the previous network drivers will become deactivated. For recommended network adapters, which will be associated with the performance driver, the service will not be enabled.

Basler recommends unbinding the Basler filter driver from network adapters that are not used for a camera and from compatible network adapters that are used with the Basler performance driver.

As an example, the following procedures describe how to unbind the Basler filter driver from a network adapter:

### To unbind the filter driver from a network adapter:.

1. Open the **Network Connections** window in the Windows Control Panel. For quick access, press the Windows + **R** keys, enter `ncpa.cpl` and press the **Enter** key.
2. Find the entry for the network adapter from which you want to unbind the Basler network driver.
3. Right click on the name of the network adapter.
4. Select **Properties** from the context menu. A **LAN Connection Properties** window for the adapter will open.
5. Look for the list box in the middle of the window that is labeled **This connection uses the following items**.
6. In the list, find the entry for **Pylon GigE Vision Streaming Filter** and uncheck the entry.
7. Click the **OK** button.
8. The driver will be unbound and the **Properties** window will close.

The Basler network driver is unbound.



You can completely uninstall the Basler filter driver by clicking on its entry in the list and then clicking the **Uninstall** button. Be aware that doing so will remove the Basler filter driver from all network adapters.



# 5 Installing a USB 3.0 Camera

## 5.1 General Considerations

The installation procedures assume that you will be making a peer-to-peer connection between your camera and a computer.

Make sure that the following items are available before starting the installation:

- A Basler USB 3.0 camera.
- As applicable, a C-mount or CS-mount lens for the camera.

If you already know what lens you will be using in your actual application, use this lens during the camera installation and setup. If not, Basler suggests using a zoom lens for your initial installation and setup. Contact Basler technical support if you need assistance in determining the best lens for your application. The support contact numbers appear in the title pages of this manual.

- A computer with a USB port. The port can be realized via a mainboard-based host adapter or via a separately installed host adapter card. For recommendations, see Section 5.2 on [page 44](#).



### USB 2.0 Compatibility

- **dart and pulse cameras:**

- All Basler dart USB 3.0 cameras are USB 2.0 backward compatible. However, functionality and data transmission rate of the camera will be limited if connected to a USB 2.0 port.
- For information about suitable USB 2.0 host controllers and about optimizing the USB 2.0 data transmission rate, see the application note *Recommended USB 2.0 Host Controllers for Basler dart and pulse Cameras* (AW001344). You can download the document from the Basler website: [www.baslerweb.com](http://www.baslerweb.com)

- **ace cameras:**

- When connected to a USB 2.0 port, Basler ace USB 3.0 cameras will be detected but can't be operated (see also [Figure 6 on page 50](#)).

The computer must be equipped with an appropriate operating system. For recommendations, see Section 3.1 on [page 4](#).

- A USB cable. Contact your Basler sales representative for ordering a suitable cable assembly.

You should perform the software installation procedure first and the hardware installation procedure second.

## 5.2 USB 3.0 Host Controller Recommendations

So far, Basler has found the following host controller chipsets to work well with Basler USB 3.0 cameras:

- the Renesas USB 3.0 host controller chipsets.  
The Renesas chipsets are for example used on ASUS PCIE USB3 host adapters.
- the Intel Ivy bridge host controller chipsets.

Evaluations of other USB 3.0 host controller chipsets are continuously updated. Contact Basler technical support for the latest information about other recommended chipsets.

For more information, see the *USB 3.0 Host Controllers' Maximum Bandwidth Measurements* (AW001260) application note on the Basler website: [www.baslerweb.com](http://www.baslerweb.com).

## 5.3 Software Installation

### 5.3.1 Installing the Basler pylon Camera Software Suite

To install the Basler pylon Camera Software Suite for use with a USB 3.0 camera, follow the instructions in Chapter 3 on [page 4](#).

### 5.3.2 Installing the Host Controller Driver

#### Installation Under Windows 7



Make sure to use the correct driver (xHCI driver) for the host controller chipset used for the USB 3.0 port:

If you use a host controller with a Renesas chipset, Basler strongly recommends to **only** install an xHCI driver supplied with the Basler pylon Camera Software Suite and **not** to use an xHCI driver from a different source.

**To install a suitable host controller driver:**

1. Click **Start > All Programs > Basler > pylon 5 Camera Software Suite > Tools & Drivers > USB 3.0 Host Controller Drivers**.

The **Tools** folder opens showing the xHCI driver setup packages and a **Readme.txt** file. The readme file includes information about the matching driver setup for each variant of the Renesas host controller chipset.

2. Install the matching xHCI driver setup package for the Renesas host controller chipset.



If you are not sure which chipset is used, install both xHCI driver setup packages that are delivered with the Basler pylon Camera Software Suite.

- If the host controller uses a Renesas  $\mu$ PD720200 or  $\mu$ PD70200A chipset:
  - a. Click **Renesas-USB3-Host-Driver-21390-setup.exe** to install the matching xHCI driver setup package.
- If the host controller uses a Renesas  $\mu$ PD720201 or  $\mu$ PD720202 chipset:
  - a. Click **Renesas 3.0.23.0.zip** to unpack the matching xHCI driver setup.
  - b. Click **Renesas-USB3-Host-Driver-30230-setup.exe** to install the matching xHCI driver setup package.

The matching xHCI driver is installed.

**Installation Under Windows 8 or Higher**

Use the xHCI driver that is included in the Windows 8, Windows 8.1, or Windows 10 operating system on your computer. The xHCI driver is suitable for **all** brands of host controller chipsets for USB 3.0 ports. The driver is already installed.

## 5.4 Hardware Installation

### 5.4.1 Precautions



**Before installing a Basler USB 3.0 camera, read the precautions in the camera user's manual:**

- *ace USB 3.0 User's Manual (AW001234)*
- *dart USB 3.0 User's Manual (AW001305)*
- *pulse USB 3.0 User's Manual (AW001345)*

## 5.4.2 Connectors of USB 3.0 Cameras

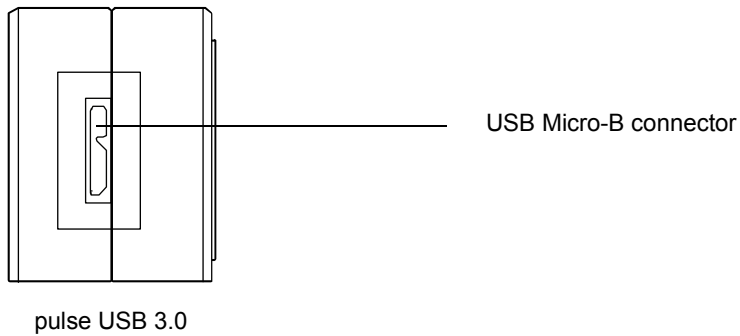
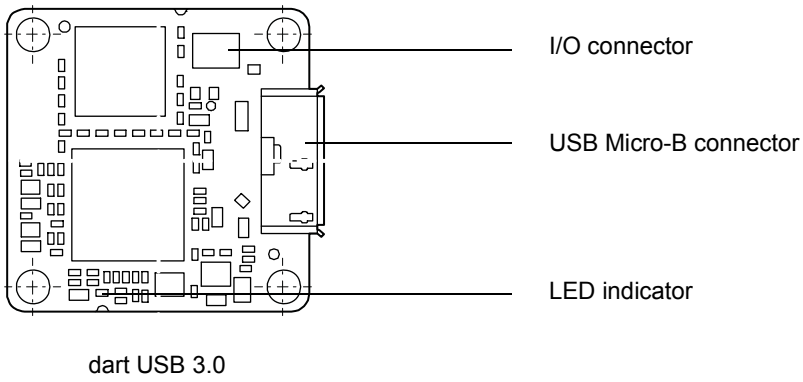
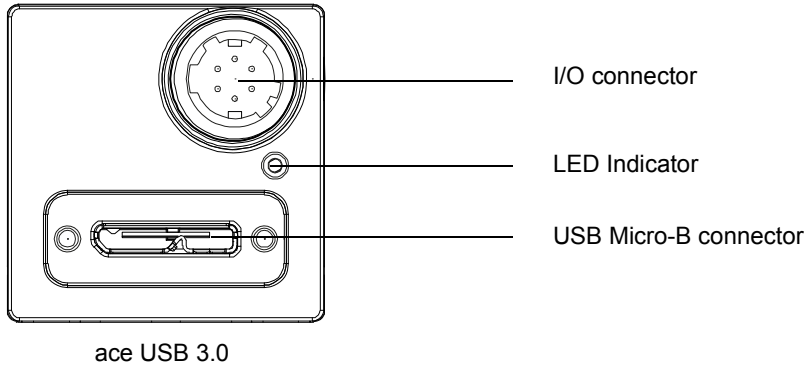

Drawings are not to scale

## 5.4.3 Installation

The following procedure assumes that these steps have already been carried out:

- Basler pylon Camera Software Suite has been installed on your computer.
- You have installed a suitable host controller driver for the USB 3.0 adapter that you will use for camera installation.

### To install the camera hardware:

1. For **ace** cameras: Remove the protective cap from the lens mount.  
For **pulse** cameras: Remove the protective seal from the lens mount.  
For **dart S-mount and CS-mount** cameras: If you want to use the I/O connector, remove the protective seal from the I/O connector.  
For **dart bare board** cameras: Remove the protective seal from the sensor. If you want to use the I/O connector, also remove the protective seal from the I/O connector.
2. Mount a lens on the camera.
3. Mount the camera in your test setup and, if required, install cooling devices for cooling the camera.
4. For **ace** and **dart** cameras: If you want to use any of the camera's I/O lines, carry out the following steps:
  - a. Connect one end of the I/O cable to the I/O connector of the camera.
  - b. Connect the other end of the I/O cable to the device intended for sending and receiving I/O signals.
5. Connect the USB cable:
  - a. Connect one end of the USB cable to the USB Micro-B receptacle on the camera.
  - b. Connect the other end of the USB cable to a USB port of your computer.  
For **ace** cameras: You must connect the camera to a USB 3.0 port. When connected to a USB 2.0 port, the camera will be detected but can't be operated.  
For **dart** and **pulse** cameras: Basler strongly recommends connecting the camera to a USB 3.0 port. When connected to a USB 2.0 port, functionality and data transmission rate of the camera will be limited.  
USB 3.0 ports are either marked with a SuperSpeed logo or have a blue insert.

The camera will power up. Windows will find the suitable camera driver in the Basler pylon Camera Software Suite.

You can now use the **USB Configurator** (see Section 5.5 on [page 49](#)) to

- obtain information about the device tree to which your camera is connected, obtain information about the devices, including your camera, and
- prepare a report.

You can also use the **pylon Viewer** (see Section 8.1 on [page 67](#)) to

- check whether your camera was detected
- acquire images, display images, and
- adjust parameter settings to improve image quality.

## 5.5 Using the USB Configurator

The USB Configurator allows you to obtain information about the architecture of the device tree to which your camera is connected and about the devices, including your camera. The information can be displayed at selectable levels of detail.

### To display the USB device tree and device information:

1. Double-click the **pylon USB Configurator** icon on your desktop.

The pylon USB Configurator window opens:

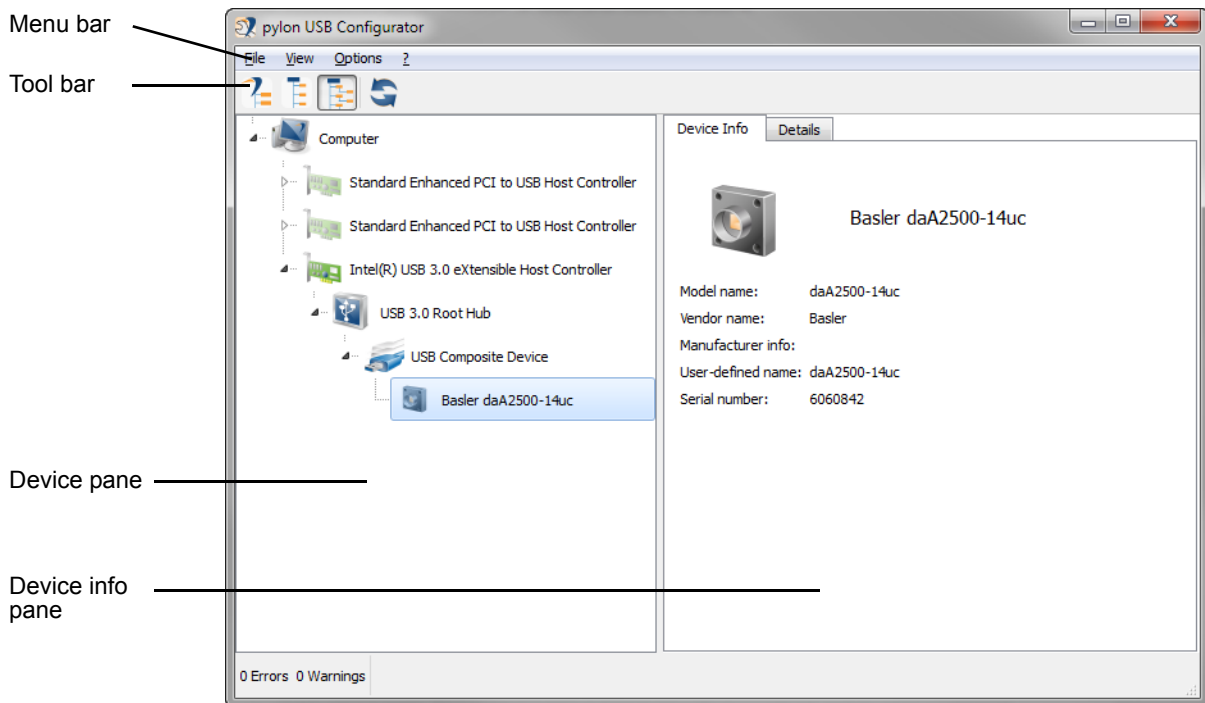

Fig. 5: pylon USB Configurator Window (dart Camera Shown as an Example)

- In the **device pane**, a USB device tree is displayed with your camera and all other connected devices. The symbols for USB 2.0 devices appear in pale colors, the symbols for USB 3.0 devices in more intense colors.
- Using the buttons in the **tool bar**, you can refresh the USB device tree and select the level of detail for the device tree.
- The **device info pane** displays information about the device that is currently highlighted in the device pane.

## Indication of Warning and Error Conditions

The USB Configurator also indicates warning and error conditions. In the example shown below, an acA2500-14uc camera is erroneously connected to a USB 2.0 adapter. In this case, the camera is detected but will not operate.

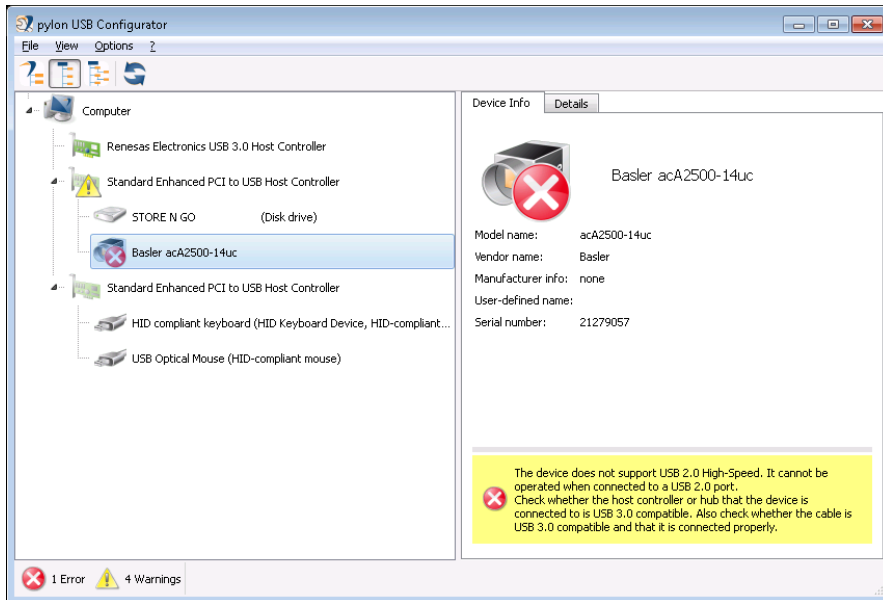

Fig. 6: pylon USB Configurator Window Displaying an Error Condition

## Creating a Report

The USB Configurator provides a convenient way of creating a report about the current USB device tree and its devices. If you need assistance, you can send the report to Basler technical service. There, the report will greatly help to assess your current installation and give you detailed advice.

### To create a report:

1. In the **pylon USB Configurator** window:
  - a. In the menu bar, click **? > Generate Support Information...**  
The **Support Information** window opens displaying the report.



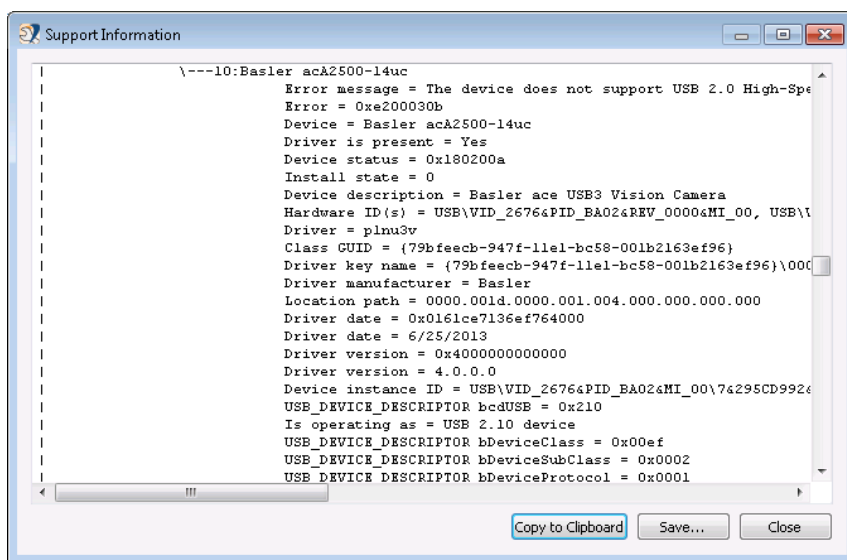

Fig. 7: Support Information Window Displaying a Report

2. To send the report to Basler technical support, click the **Copy to Clipboard** button and include the report in an email to Basler technical support.
3. To save the report on your computer, click the **Save** button.

# 6 Installing a FireWire Camera

## 6.1 General Considerations

Make sure the following items are available before starting installation:

- A Basler scout FireWire (IEEE 1394) camera.
- A C-mount lens. If you already know what lens you will be using in your actual application, use this lens. Otherwise, Basler suggests using a zoom lens for initial setup. Contact Basler technical support if you need assistance in determining the best lens for your application. The contact numbers appear in the title pages of this manual.
- A computer with an appropriate operating system (see Section 3.1 on [page 4](#)).



The pylon drivers for IEEE 1394 have been successfully tested with the 64-bit versions of Windows 8 and Windows 8.1. However, as newer Windows versions (8 and higher) no longer explicitly support IEEE 1394, Basler may decide to discontinue IEEE 1394 support completely in upcoming pylon releases for Windows 8 and higher. Basler strongly recommends not to use cameras with the IEEE 1394 camera interface for applications running under Windows 8 or higher.

There is no support for FireWire cameras on the 32-bit versions of Windows 8.

- A FireWire (IEEE 1394) adapter installed in the computer.

If you use a computer with an IEEE 1394 adapter, make sure the adapter is configured to supply between +8 and +36 VDC to the camera. Also make sure the adapter can supply at least the required power to the camera. Refer to the specification table in the first section of this manual for more information about camera power consumption. For example, 2.5 W are typically required for the sCA640-70fm/fc at 12 VDC.

If you use a laptop with an IEEE 1394 connector, note that on almost all laptops, it will be an IEEE 1394a connector. Also note that most laptops **do not** supply power via the IEEE 1394 connector. In this case, you must do **either** of the following:

- Use a powered hub between the laptop and the camera, and make sure that the hub can supply the required power to the camera.
- Install a PCMCIA IEEE 1394 adapter card in the laptop that connects to an external power supply, and make sure that the power supply can supply sufficient power to the camera.
- IEEE 1394 cables. To connect an IEEE 1394b camera to an IEEE 1394b adapter, a standard, 9-pin shielded IEEE 1394b to 1394b cable should be used. The maximum length between the camera and the computer or the hub is 4.5 m.

If you want to connect the camera to an IEEE 1394a device, as applies to most laptops, you must use a conversion cable. The cable will have a 9-pin IEEE 1394b plug on the end that connects to the camera and a 6-pin IEEE 1394a plug on the end that connects to the computer or the powered hub.

Figure 8 shows a variety of ways that an IEEE 1394b camera can be connected to an IEEE 1394 adapter in a computer. Refer to the figure and plan your cabling needs now.

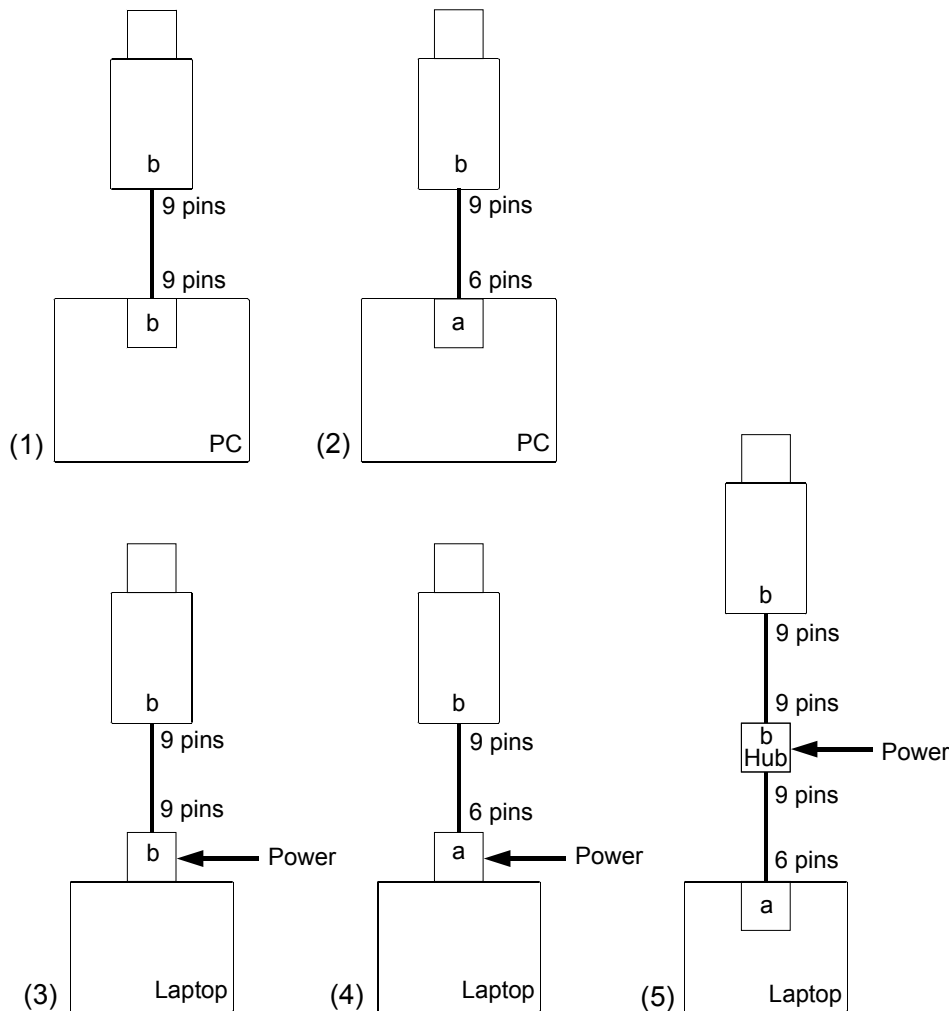

Fig. 8: Different Ways to Connect an IEEE 1394b Camera to a Computer

- (1) Camera linked to a PC equipped with an IEEE 1394b compliant adapter. The camera receives power from the computer. Required cable: 1394b to 1394b.
- (2) Camera linked to a PC equipped with an IEEE 1394a compliant adapter. The camera receives power from the computer. Required cable: 1394b to 1394a.
- (3) Camera linked to a laptop computer equipped with a powered IEEE 1394b compliant adapter card. The camera receives power from the card. Required cable: 1394b to 1394b.
- (4) Camera linked to a laptop computer equipped with a powered IEEE 1394a compliant adapter card. The camera receives power from the card. Required cable: 1394b to 1394a.
- (5) Camera linked to a powered IEEE 1394b compliant hub which is linked to a laptop computer with an IEEE 1394a compliant adapter. The camera receives power from the hub. Required cables: 1394b to 1394b and 1394b to 1394a.

## 6.2 Software and Hardware Installation

### 6.2.1 Precautions



Before installing a Basler FireWire camera, read the precautions in the *scout-f User's Manual* (AW000115).

### 6.2.2 Installing the Basler pylon Camera Software Suite

To install the Basler pylon Camera Software Suite for use with a FireWire camera, follow the instructions in Chapter 3 on [page 4](#).

#### NOTICE

**Uninstalling pylon software while the camera is connected to the IEEE 1394 bus may cause a bluescreen.**

Make sure to unplug the plug of the IEEE 1394 cable from the camera before you start uninstalling pylon software. If you can not unplug the plug switch off camera power.



During installation of the Basler pylon 1394 camera driver, the current camera-driver associations may be changed.

Depending on the conditions before and during installation, you will find your FireWire camera associated with one of the following camera drivers after the installation:

- generic 1394 desktop camera driver
- Basler BCAM 1394 camera driver (from a previous installation of BCAM software)
- Basler pylon 1394 camera driver

For information about checking and, if necessary, changing the current camera driver association, see Section 6.2.3 on [page 55](#).

## 6.2.3 Associating a FireWire Driver with Your Camera

The following procedures assume that you have the Basler pylon Camera Software Suite installed on your computer, including the Basler pylon 1394 camera driver.

1. Open a **Device Manager** window by doing the following:
  - a. Press the Windows key + **R** key to open the **Run** window.
  - b. When the **Run** window opens, type in: `devmgmt.msc`
  - c. Click the **OK** button.
  - d. The **Device Manager** window opens and displays a list of device classes as shown below.

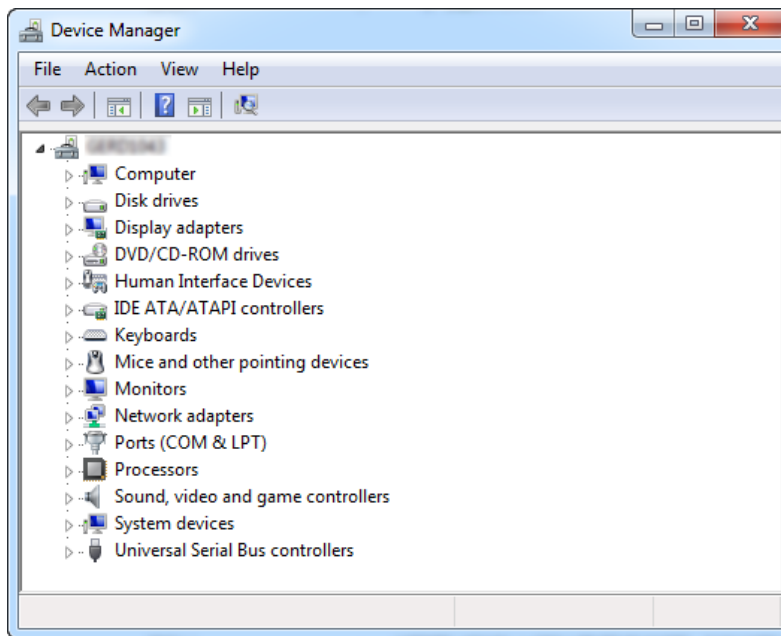

2. Get **one** of your FireWire cameras and do the following:
  - a. Make sure your camera is connected to an IEEE 1394 adapter in the computer.
  - b. Wait for the device manager to detect the camera.  
(This process can take several minutes. While the process is going on, you may see the list of device classes in the window open and close several times.)
3. Once detection is complete, find the listing for the camera in the device manager to check the current camera-driver association.

If the camera has never been attached to your computer, you should now find a device class called **Imaging Devices**. When you click the plus sign next to **Imaging Devices** you will find a listing for a **Generic 1394 Desktop Camera**. This situation indicates that the system detected the camera and associated it with a generic 1394 camera driver.

If the camera has been attached to your computer before and you used Basler's BCAM driver, you may find a device class called **Basler 1394 Digital Cameras**. When you click the plus sign next to **Basler 1394 Digital Cameras**, you will find a listing for a **Basler XXX BCAM digital camera** (where XXX is a camera name). This situation indicates that the system detected the camera and associated it with Basler's BCAM camera driver.

If the camera has been attached to your computer before and you used an older version of the Basler pylon 1394 camera driver, you may find a device class called **Basler pylon 1394 Digital**

**Cameras.** When you click the plus sign next to **Basler pylon 1394 Digital Cameras**, you will find a listing for a **Basler XXX digital camera** (where XXX is a camera name). This situation indicates that the system detected the camera and associated it with the Basler pylon 1394 camera driver.

This driver will be the **new version** of the Basler pylon 1394 camera driver that was updated during the preceding installation of the Basler pylon software.

4. If you are satisfied with the current camera-driver association, go to step 9.

If you want to change the current camera-driver association, do the following:

- a. Right click on **Generic 1394 Desktop Camera**, on **Basler XXX BCAM digital camera** or on **Basler XXX digital camera** (whichever one you saw in step 3).
- b. Select **Update Driver Software ...** from the context menu that appears.

The Update Driver Software window opens.

5. Click **Browse my computer for driver software**.

6. Click **Let me pick from a list of device drivers on my computer**.

7. Assume in this and the following steps, for example, that you want to change the current camera-driver association to the association with the Basler pylon 1394 camera driver:

In the list box of the Update Driver Software window, you should now see the model name of your camera followed by "(pylon)". For example, if you attached an scA640-70fm, you should see "scA640-70fm (pylon)".

- a. Click on the model name to highlight it.
- b. Click the **Next** button.

The pylon 1394 camera driver will be associated with the camera.

8. Click the **Finish** button.

Notice that your camera is now listed (by model name) under the **Basler pylon 1394 Digital Cameras**. Any device listed under the **Basler pylon 1394 Digital Cameras** device class is associated with the Basler pylon 1394 driver.

If there are multiple cameras of the same model listed under the device class, they will be listed by the model name followed by "camera 1", "camera 2", etc.

9. If you use only one FireWire camera with your computer, your camera is now associated with the desired camera driver. You can close the **Device Manager** window and exit this procedure.

If you use more than one FireWire camera with your computer, perform steps 2 through 8 for each FireWire camera.

# 7 Installing a Camera Link Camera

## 7.1 General Considerations

The installation procedures assume that you will be making a connection between your camera and a frame grabber installed in a computer.

Make sure that the following items are available before starting the installation:

- A Basler Camera Link camera that is specifically designed for use with Basler pylon software (*ace*, *aviator*, *beat*, or *racer*).
- For **aviator** cameras or if you are not using Power over Camera Link (PoCL): A power supply for the camera. Make sure that the power supply meets all of the requirements listed in the camera user's manual.
- For **ace** and **aviator** cameras: A C-mount lens for the camera.

For **racer** and **beat** cameras: A suitable lens adapter and a lens for the camera. For more information about suitable lens adapters, see the camera user's manual.

If you already know what lens you will be using in your actual application, use this lens during the camera installation and setup. If not, Basler suggests using a zoom lens for your initial installation and setup. Contact Basler technical support if you need assistance in determining the best lens for your application. The support contact numbers appear in the title pages of this manual.

- A computer equipped with a Camera Link frame grabber. The frame grabber must support at least the base Camera Link configuration. It also must be able to handle the desired Camera Link pixel clock speed (see Section 7.2 on [page 58](#)).

The computer must be equipped with an appropriate operating system (see Section 3.1 on [page 4](#)).

- An appropriate AC power cable (see the camera user's manual).
- Appropriate Camera Link cables (see the camera user's manual).

For **ace** and **racer** cameras: If you supply camera power via PoCL, you must use Camera Link cables that are specifically designed for PoCL as specified in the Camera Link standard.

- For **ace** and **aviator** cameras: An appropriate cable for connecting the camera's I/O lines if desired (see the camera user's manual).

You should perform the hardware installation procedure first and the software installation procedure second.

## 7.2 Frame Grabber Preparations

The following procedures assume that you have installed a Camera Link frame grabber in your computer, that you have properly installed all software included with the frame grabber, and that you understand how your frame grabber operates.

**To correctly use a Camera Link camera, you must be thoroughly familiar with the operation of your frame grabber.**

Camera and frame grabber must be compatible with respect to the Camera Link clock speed. For example, all ace Camera Link models have a default Camera Link clock speed of 82 MHz. However, not all frame grabbers are compatible with a clock speed this high. You should check the documentation for your frame grabber and make sure that it can operate at a 82 MHz pixel clock speed. If it cannot, the clock speed on the camera can be lowered.

For more information about changing the Camera Link pixel clock speed, see the camera user's manual.

### 7.2.1 Location of the Serial Port File

All Camera Link compliant frame grabbers must be supplied with a dll file which describes the characteristics of a serial port that is built into the frame grabber. This serial port is used for communication between your computer and your camera via the Camera Link interface.

The name of the file supplied by the frame grabber manufacturer will have the form **clser\*\*\*.dll**.

For 32-bit and 64-bit versions of your frame grabber's dll, \*\*\* is determined by the manufacturer of the grabber and usually represents the manufacturer's name. For example, a frame grabber made by the "Acme" company may supply a file called **clseracm.dll**.

In the standard case, your frame grabber's dll \*\*\* will be located at the following path: **%Program Files%\CameraLink\Serial**

The frame grabber software should take care that the dll file is located correctly for the computer-to-camera communication via the serial port. If no communication can be established, check whether the dll file is located at the path specified by the Windows registry key **HKEY\_LOCAL\_MACHINE\SOFTWARE\CAMERA LINK\CLSerialPath**. If the dll file is not at this location, contact the frame grabber vendor.



## 7.2.2 Frame Grabber Camera Files

For your camera to operate properly with your frame grabber, you must install the correct frame grabber camera file. In essence, the camera file informs the frame grabber about how the pixel information coming from the camera will be ordered and about the bit depth of the pixel data. Depending on the frame grabber supplier, there can be a separate camera file for each combination of camera model and pixel data format or a camera file may cover several different camera models.

Typically, each frame grabber supplier has a different naming scheme for their camera files. For example, Matrox refers to the camera files for their grabbers as "Digital Configuration Files" or DCF files and National Instruments refers to theirs as "Interface Camera Descriptors" or ICD files. Camera files appropriate for the camera (e.g. the aviator Camera Link camera) must be supplied by your frame grabber manufacturer. If you don't have the camera files for your frame grabber, you can usually find them on the supplier's web site.

Once you have the camera files, there are three things you must keep in mind:

- The camera file that you obtain and install must be appropriate for the pixel data format setting that you will be using on your camera. Refer to the camera user's manual for information about available pixel data formats.
- The camera file must be installed in the correct location on your computer. This location varies depending on your frame grabber supplier. Consult the documentation for your frame grabber to determine where the camera files should be installed.
- The camera must be set for your desired pixel data format. You can set the camera's pixel data format using the pylon API or the pylon Viewer.

## 7.3 Hardware Installation

### 7.3.1 Precautions



**Before installing a Basler Camera Link camera, read the precautions in the camera user's manual:**

- *ace Camera Link User's Manual (AW000985)*
- *aviator Camera Link User's Manual (AW000830)*
- *beat Camera Link User's Manual (AW001308)*
- *racer Camera Link User's Manual (AW001185)*

### 7.3.2 Connectors of Camera Link Cameras

26-pin SDR Connector  
(Base Camera Link Connection;  
Power and Data)

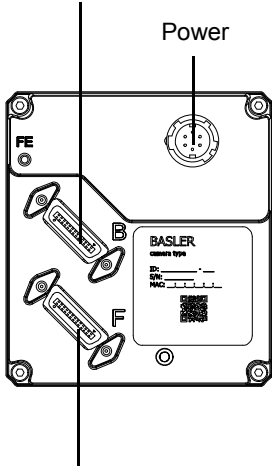

26-pin SDR Connector  
(Medium/Full Camera Link  
Connection; Data)

racer Camera Link

26-pin SDR Connector  
(Base Camera Link Connection;  
Power and Data)

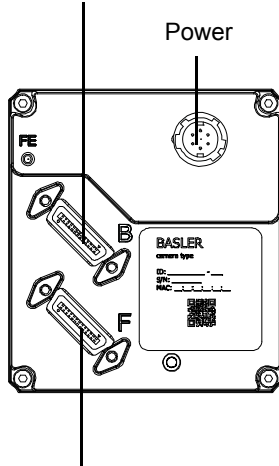

26-pin SDR Connector  
(Medium/Full Camera Link  
Connection; Data)

beat Camera Link

26-pin SDR Connector  
(Medium/Full Camera Link  
Connection; Data)

26-pin SDR Connector  
(Base Camera Link  
Connection; Power and  
Data)

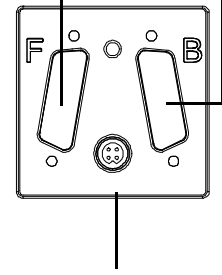

Power and I/O

ace Camera Link

Power I/O Only 26-pin MDR Connector

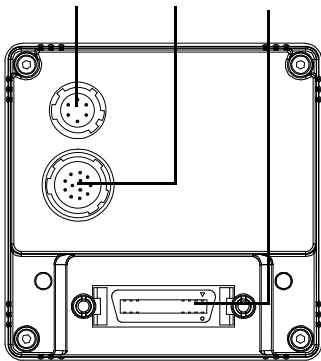

aviator Camera Link

Drawings are not to scale

## 7.3.3 Installation

To install the camera hardware, follow these steps:

1. **Make sure that your camera power supply is not connected to the camera and that the power to your host computer is switched off.**
2. For **ace** and **aviator** cameras: Remove the cap or the seal from the lens mount on the camera and mount a lens on the camera.  
For **beat** and **racer** cameras: Remove the seal from the camera front. Attach a suitable lens adapter to the camera and mount a lens on the camera.
3. Mount the camera in your test setup.
4. For **aviator** cameras: Plug one end of a Camera Link cable into the MDR connector of the camera and the other end of the Camera Link cable into the base configuration connector of your frame grabber.
5. For **ace**, **beat**, and **racer** cameras:
  - a. Plug one end of a Camera Link cable into the base SDR connector of the camera and the other end of the Camera Link cable into the base configuration connector of your frame grabber.
  - b. Plug one end of a Camera Link cable into the medium/full SDR connector of the camera and the other end of the Camera Link cable into the medium/full configuration connector of your frame grabber.
6. Make sure that the connectors on the cable are securely fastened to the camera and the frame grabber. **If the connectors are loose, they will cause problems with your images.**
7. Switch on the power to your host computer and let the computer boot up.
8. For **aviator** cameras or if you are not using Power over Camera Link (PoCL):
  - a. Connect the plug of the power supply's output cable to the 6-pin power connector of the camera.
  - b. Plug the power supply into an AC outlet.

Hardware installation is complete. Continue with the software installation procedure.

## 7.4 Software Installation

To install the Basler pylon Camera Software Suite for use with a Camera Link camera, follow the instructions in Chapter 3 on [page 4](#).



- If you are installing pylon on a 32-bit Windows operating system, the 32-bit version of your frame grabber's **clser\*\*\*.dll** file must be installed.
  - If you are installing pylon on a 64-bit Windows operating system, the 32-bit or 64-bit version of your frame grabber's **clser\*\*\*.dll** file must be installed.
- If these conditions are not satisfied, Camera Link cameras will not be detected.

## 7.5 Configuring the Camera Link Serial Port

To communicate with the camera, the pylon Camera Software Suite uses a serial port that is built into the Camera Link interface on your frame grabber. Before the pylon software can communicate with the camera, you must configure the serial port.

To configure the Camera Link serial port:

1. Double-click the **pylon CL Configurator** icon on your desktop.



- If the 32-bit version of your frame grabber's **clser\*\*\*.dll** files is installed, you must run the 32-bit version of the pylon CL Configurator.
- If the 64-bit version of your frame grabber's **clser\*\*\*.dll** files is installed, you must run the 64-bit version of the pylon CL Configurator

2. A **pylon CL Configurator** window will open as shown below. The following figure shows the **pylon CL Configurator** window for the 64-bit version of the Basler pylon software as an example.

A list of ports that are supported by the Camera Link interface will be displayed in the window.

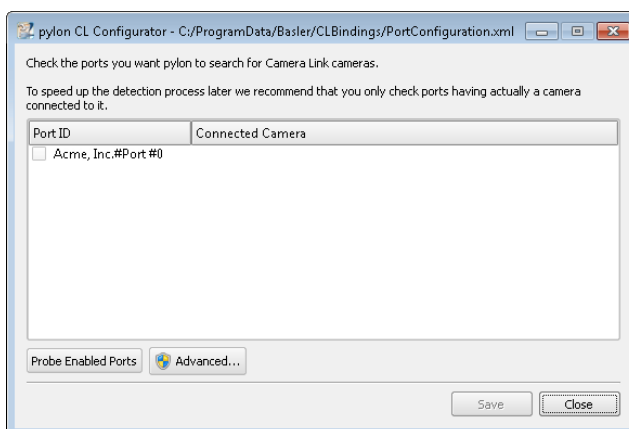

- Determine which port will be used for communication between the computer and the camera. Usually, this will be the port that is built into the frame grabber. For the port on the frame grabber, you will typically see the name of the frame grabber manufacturer included as part of the port name. In the example shown below, a frame grabber from the "Acme" company is used and "Acme" is included as part of the port name.

Select the port that you want to use as shown below.

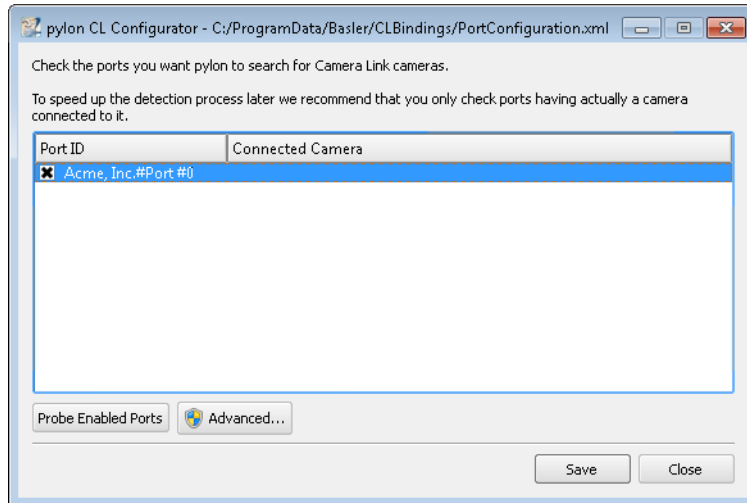

In the following step, you will be probing ports to see if cameras are attached. Basler suggests only probing the port(s) that you will be using to communicate with a Camera Link camera running with Basler pylon software.

Probing a port that has a device other than a Camera Link camera running with Basler pylon connected to it may change the configuration of the port and may cause the device to stop operating correctly.

- Click the **Probe Enabled Ports** to probe the selected port(s). This will probe the selected port(s) to see if a camera is connected to the port. This may take up to approximately one minute for each port.



You can also probe an individual port by right clicking on a port ID in the list and clicking on **Probe this port** from the menu that appears.

During the probing, the CL Configurator will test whether data can be reliably transmitted from the camera at the maximum possible baud rate supported by the frame grabber.

If a camera is detected, it will be indicated in the **pylon CL Configurator** window.

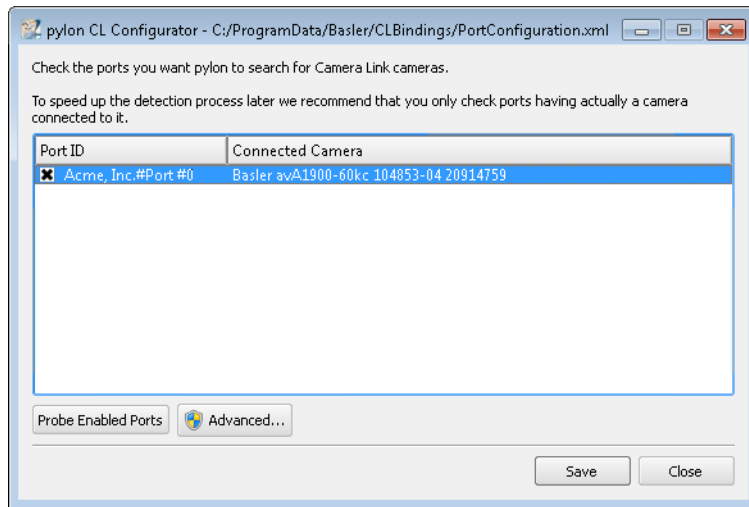

If an error is detected, the test will be repeated at successively lower baud rates until a maximum baud rate is found where all data are reliably transmitted. When this is achieved, a warning message will open informing that data is not reliably transmitted at the maximum possible baud rate:

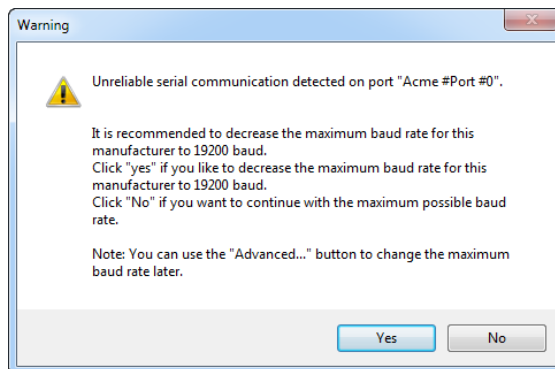

5. If the warning message has opened, take the following steps to ensure the most efficient data transmission:
  - a. Check connectors and cable of the serial connection.
  - b. Obtain, if available, an updated **clser\*\*\*.dll** file from the frame grabber manufacturer.

	<p>You need administrative privileges to change the baud rate in the next step.</p>
---	---

- c. Click **Yes**. This will automatically set a maximum baud rate for the port where reliable data transmission is ensured. If you click **No**, the maximum possible baud rate supported by the frame grabber will be used but reliable data transmission is not ensured.
- d. If you want to set the baud rate manually, click the **Advanced...** button in the **pylon CL Configurator** window.



You need administrative privileges to use the Advanced Baud Rate Settings window.

The **Advanced Baud Rate Settings** window opens.

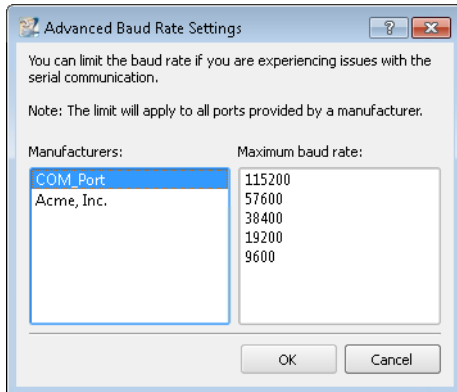

Select a frame grabber manufacturer in the left pane and set a maximum baud rate in the right pane. The set maximum baud rate will apply for all ports related to the selected manufacturer.

- e. Click **OK** to save the settings and close the window.
6. Click the **Save** button to save the port configuration and click the **Close** button to close the CL Configurator.



# 8 Next Steps

## 8.1 Acquiring Your First Images

The easiest way to acquire your first images is to use the pylon Viewer software that was installed earlier with the pylon Camera Software Suite.



For Camera Link cameras, the pylon Viewer can only be used for camera configuration. Images will not be displayed.

### To acquire your first images:

1. Put an object within the camera's field of view and make sure that the object is well illuminated.
2. Double-click the **pylon Viewer** icon on your desktop.  
The pylon Viewer will open as shown below and you should see an entry in the **Devices** pane for your camera.

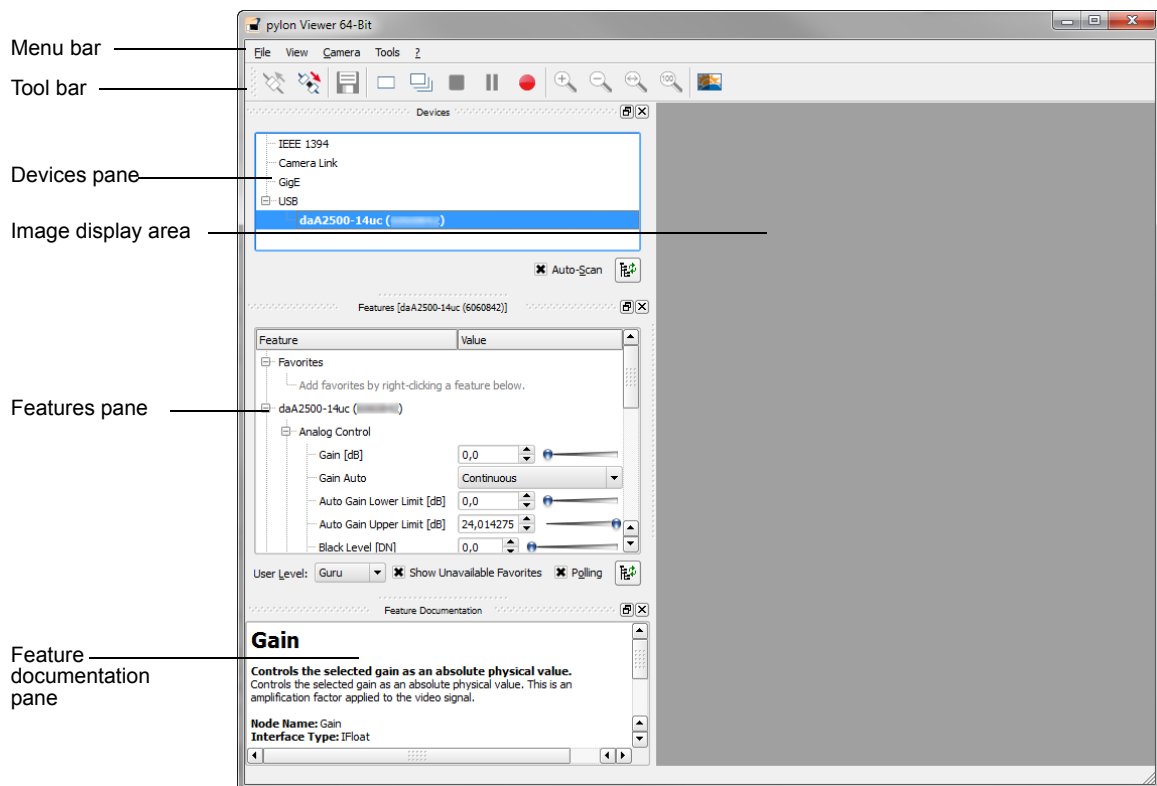

Fig. 9: Overview of the pylon Viewer

If you are using a GigE, USB, or Camera Link camera and the camera is not shown in the **Devices** pane, you can use the pylon IP Configurator, the pylon USB Configurator, or the pylon CL Configurator to check and configure the device.

For more information about these tools, see the following sections:

- IP Configurator: Section 4.6.4 on [page 34](#).
- USB Configurator: Section 5.5 on [page 49](#).
- CL Configurator: Section 7.5 on [page 63](#).

3. Double-click your camera's name in the **Devices** pane to open the camera connection.
4. In the menu bar, click **Camera > Continuous Shot** to place the camera into continuous image capture mode.

The images captured by the camera will be displayed in the image display area as shown below.

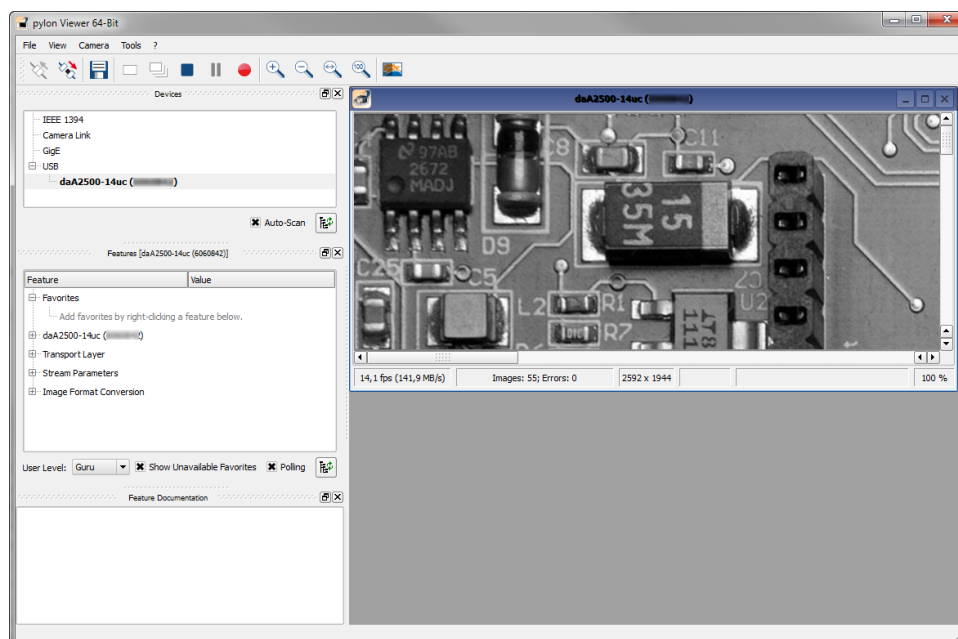

Fig. 10: pylon Viewer Displaying an Image

5. In the menu bar, click **View > Zoom to Fit** to make the image fit into the image display area.
6. Focus the lens until the image is properly focused.

If you vary the light intensity on the object, the camera will automatically adjust the image quality. This happens because the auto gain and exposure controls are running continuously.

Now that you have started capturing images, you should familiarize yourself with the camera's parameter settings. In the **Features** pane, click the **+** icon next to your camera's name. A list of setting categories will appear.

## 8.2 Learning How to Configure and Optimize Your Camera

Information about how to configure your camera, how to optimize image quality, and how to optimize the bandwidth consumption of the connected cameras can be found in the **online help** of the pylon Viewer.

**To access the online help of the pylon Viewer:**

1. Double-click the **pylon Viewer** icon on your desktop.  
The **pylon Viewer** window opens.
2. In the menu bar, click **? > View Help**. For quick access, press the **F1** key.

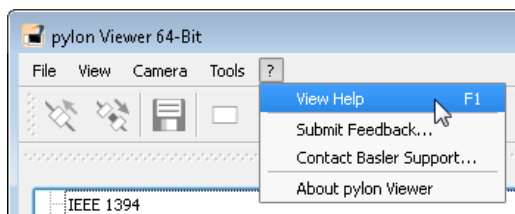

The online help window opens.

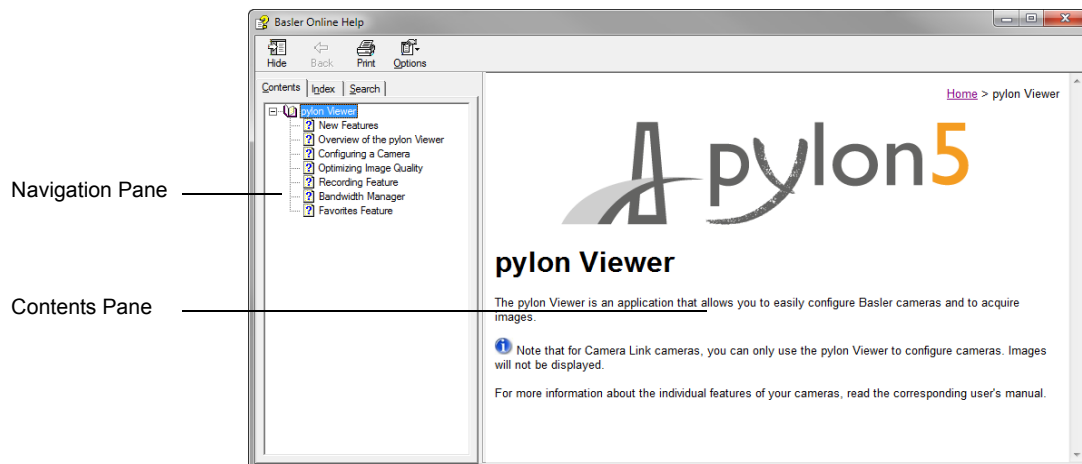

3. Click on an entry in the navigation pane to display a specific topic:
  - The **Configuring a Camera** topic provides information about how to acquire images and how to make camera settings more suitable for your specific application.
  - The **Optimizing Image Quality** topic provides information about how to optimize your image quality.
  - The **Bandwidth Manager** topic provides information about how to optimize the bandwidth consumption of the connected cameras.

## 8.3 Additional Camera Settings

At this stage, you will have succeeded in acquiring images and controlling the camera using the pylon Viewer and you were able to optimize the image quality (see Section 8.2 on [page 69](#)).

To meet the requirements of your application, you will likely need to make additional camera settings and to modify previous camera settings.

If you have not already done so, implement the typical conditions of operation as required by your application before proceeding with the next steps. In particular, choose the lens and the illumination required by your application.

Before making the additional camera settings, you must know the requirements for your application regarding depth of focus, acquisition frame rate, size of the ROI (also known as AOI), and contrast. And you must know what the priorities of the requirements are since some of the settings depend on each other or have opposite effects. For example, a desired high acquisition frame rate may not be reachable with the exposure time set to a high value or with the area of interest set to full resolution.

Your next steps will involve all or some of the following:

- Selecting the pixel format and frame rate (area scan cameras) or line rate (line scan cameras).
- Defining an image ROI (also known as AOI).
- Controlling exposure by selecting a trigger scheme and by setting the exposure time. If you use an external device to supply the trigger, you must also connect the camera to the external device using the I/O cable.
- Controlling the frame rate (area scan cameras) or line rate (line scan cameras) by using the Acquisition Frame Rate or Acquisition Line Rate parameter or with trigger signals.
- For color camera models: Applying advanced color enhancements, e.g. color adjustment or color transformation.
- Enabling and parameterizing I/O signals.
- Enabling and parameterizing camera features.
- Saving parameter settings as a user set.

See

- the camera User's Manual for details about camera operation and features.
- the *Programmer's Guide and Reference* (C++, C, and .NET) included in the pylon Camera Software Suite for information about setting and controlling the camera via a GenICam based API.

Basler recommends controlling the camera via the API when taking the next steps.

Contact Basler technical support if you need further assistance. The contact numbers appear in the title pages of this manual.

# 9 Uninstalling or Changing the pylon Camera Software Suite

## NOTICE

**Uninstalling pylon software while a camera is connected to the IEEE 1394 bus can cause a bluescreen.**

Make sure to unplug the plug of the IEEE 1394 cable from the camera before you start uninstalling pylon software. If you can not unplug the plug, switch off camera power.

When installing a newer version of the pylon Camera Software Suite, the old version will automatically be uninstalled before the new version is installed.

To uninstall pylon without installing a new version, use the standard Windows uninstallation procedure. For more information, see the "Uninstall or change a program" topic on the Microsoft website: <http://windows.microsoft.com/en-us/windows/uninstall-change-program>.



You can install the pylon Camera Software Suite side-by-side with the pylon runtime redistributable packages. If this is the case, uninstalling the pylon Camera Software Suite will not affect the installation of the pylon runtime redistributable components, and vice versa.

For more information about the pylon runtime redistributable packages, see the *pylon Deployment Guide* (AW001362).

## Revision History

Document Number	Date	Changes
AW00061101000	14 Feb 2008	<p>Initial version:</p> <p>Transferred the following sections from the User's Manuals of the scout-g (AW00011907000), scout-f (pylon) (AW00012505000), and pilot (AW00015109000) cameras: "Software and Hardware Installation", "Network Recommendations", and "Camera and Network Adapter IP Configuration".</p> <p>Restated precautions for the scout, pilot, and runner cameras.</p> <p>The instructions for SP2 partial rollback were not included from the Scout-f (pylon) User's Manual (they are now in the "Windows XP SP2 Partial Rollback" Application Notes, AW000615xx000).</p> <p>Made adjustments for Basler pilot 2.0 software.</p> <p>Added instructions for setting and adjusting packet size and frame rate.</p>
AW00061102000	20 Mar 2009	<p><b>General</b></p> <ul style="list-style-type: none"> <li>■ Made adjustments for Basler pilot 2.1 software.</li> <li>■ Updated Basler web address.</li> <li>■ Deleted sections concerning Basler pylon Driver Runtime Package.</li> </ul> <p><b>Chapter 2</b></p> <ul style="list-style-type: none"> <li>■ Added a note on page 8 indicating that an application note regarding EMI/ESD control is available.</li> </ul> <p><b>Chapter 3</b></p> <ul style="list-style-type: none"> <li>■ Adapted system requirements and installation packages.</li> <li>■ Updated pylon software components section.</li> </ul> <p><b>Chapter 5</b></p> <ul style="list-style-type: none"> <li>■ Adapted "Software Installation" on page 16.</li> <li>■ Adapted "Adjusting the Installation" on page 19.</li> <li>■ Adapted "Configuring a Network Adapter Used with the Filter Driver" on page 19.</li> <li>■ Integrated "Disabling the Windows Firewall" on page 21.</li> <li>■ Moved "limitation" note box to the beginning of section "Setting an Adapter to Use DHCP / Auto IP (LLA)" on page 42.</li> <li>■ Removed sections "Changing the Driver Association for a Compatible GigE Network Adapter" and "Unbinding the Basler Filter Driver from a Network Adapter" to newly created section "Modifying the Driver Installation" on page 54.</li> </ul> <p><b>Chapter 6</b></p> <ul style="list-style-type: none"> <li>■ Adapted "Installing the Basler pylon Camera Software Suite" on page 71.</li> <li>■ Adapted "Modifying Your Software Installation" on page 93.</li> </ul>

Document Number	Date	Changes
AW00061103000	8 Mar 2010	<p><b>General</b></p> <ul style="list-style-type: none"> <li>■ Updated the addresses in Germany and the U.S.A.</li> <li>■ Made adjustments for Basler pylon 2.2 software.</li> <li>■ Made additions/adjustments for Basler aviator and ace cameras.</li> <li>■ Minor corrections and additions throughout the manual.</li> </ul> <p><b>Chapter 4</b></p> <ul style="list-style-type: none"> <li>■ Removed instructions for removing the Basler filter driver of pylon versions 0.9 or below.</li> </ul> <p><b>Chapter 7</b></p> <ul style="list-style-type: none"> <li>■ Added the "Installing a Camera Link Camera" section.</li> </ul>
AW00061104000	16 Sep 2010	<p><b>General</b></p> <ul style="list-style-type: none"> <li>■ Removed some specific reference to the aviator camera and made information general.</li> <li>■ Made adjustments for Basler pylon 2.3 software (compatibility with Windows 7, 64-bit version for Camera Link cameras).</li> <li>■ Minor corrections and modifications throughout the manual.</li> </ul> <p><b>Chapter 5</b></p> <ul style="list-style-type: none"> <li>■ Rearranged, modified and corrected contents of Section 5.3.2 on page 21.</li> </ul>
AW00061105000	30 Sep 2010	<p><b>General</b></p> <ul style="list-style-type: none"> <li>■ Added information in Section 8.2.1 on page 78 and Section 8.4 on page 87 that the filename of a 64-bit version of a frame grabber dll file must include "_w64".</li> </ul>

Document Number	Date	Changes
AW00061106000	20 Jan 2012	<p><b>General</b></p> <ul style="list-style-type: none"> <li>■ Indicated Basler AG as bearer of the copyright on the back of the front page.</li> <li>■ Updated to Basler pylon 3.0 software whenever applicable throughout the manual.</li> </ul> <p><b>Chapter 2</b></p> <ul style="list-style-type: none"> <li>■ Included the aviator GigE camera in the precautions in Chapter 2 on page 3.</li> <li>■ Included the ace GigE camera with CS-lens mount in the precautions about limited lens thread length in Chapter 2 on page 3.</li> </ul> <p><b>Chapter 3</b></p> <ul style="list-style-type: none"> <li>■ Removed the reference to Windows 2000 SP4 and to SP2 for Windows XP in Section 3.1 on page 6.</li> </ul> <p><b>Chapter 5</b></p> <ul style="list-style-type: none"> <li>■ Included the aviator GigE camera in Section 5.4 on page 25.</li> <li>■ Corrected the automatic IP address range in Section 5.6.2.1 on page 39 and Section 5.6.3 on page 45.</li> </ul> <p><b>Chapter 7</b></p> <ul style="list-style-type: none"> <li>■ Removed the instructions about renaming 64-bit frame grabber clser**.dll files in Section 8.2.1 on page 78 and Section 8.4 on page 87.</li> <li>■ Indicated the connectors for power and I/O for aviator Camera Link cameras in the drawing in Section 8.3 on page 80.</li> </ul>
AW00061107000	10 Oct 2012	<p>Updated Section 5.6.4 on page 46 with information about new IP Configurator.</p> <p>Minor corrections.</p>



Document Number	Date	Changes
AW00061108000	17 Dec 2014	<p><b>General</b></p> <ul style="list-style-type: none"> <li>■ Minor corrections and modifications throughout the manual.</li> <li>■ Updated email addresses for technical support.</li> <li>■ Updated Basler contact address for Asia.</li> <li>■ Added export compliance information.</li> <li>■ Updated pylon 4-related language conventions.</li> <li>■ Removed Microsoft Windows XP and Vista as supported operating systems.</li> <li>■ Added Microsoft Windows 8 and 8.1 as supported operating systems.</li> <li>■ Updated instructions related to specific operating systems.</li> <li>■ Updated screenshots of the pylon software.</li> <li>■ Added information related to the installation of racer GigE and Camera Link cameras.</li> <li>■ Added information related to the installation of USB 3.0 cameras.</li> <li>■ Moved sections "Modifying Your Software Installation" from the interface-specific sections to Section 9.1 on page 93.</li> </ul> <p><b>Chapter 1</b></p> <ul style="list-style-type: none"> <li>■ Removed Section 1.1.1 ("LWIP TCP/IP Licensing").</li> </ul> <p><b>Chapter 2</b></p> <ul style="list-style-type: none"> <li>■ Moved precautions from Sections 2.1 and 2.2 to the camera interface-specific sections (see Section 5.4.1 on page 25, Section 6.4.1 on page 60, Section 7.2.1 on page 70, and Section 8.3.1 on page 80).</li> </ul> <p><b>Chapter 3</b></p> <ul style="list-style-type: none"> <li>■ Updated operating system requirements in Section 3.1 on page 6.</li> <li>■ Updated information about installing the .NET Framework 2.0 in Section 3.3 on page 7.</li> <li>■ Removed the Basler pylon VB6 Runtime and the pylon SDK for VB6 from the software features list and the recommended combinations table in Section 3.3 on page 7. These features are no longer included in the pylon software.</li> </ul> <p><b>Chapter 5</b></p> <ul style="list-style-type: none"> <li>■ Added the CS-mount to Chapter 5 on page 13.</li> <li>■ Added information in Section 5.4.3 on page 30 about multiple camera description files and related periods until the camera features become available after camera power on.</li> <li>■ Updated drawings of the GigE camera connections and moved them to a separate section (see Section 5.4.2 on page 29).</li> <li>■ Updated the list of recommended network adapters in Section 5.5.1 on page 32..</li> </ul>

Document Number	Date	Changes
		<ul style="list-style-type: none"><li>■ Updated network adapter configuration procedures in Section 5.6.2.1 on page 39, Section 5.6.2.2 on page 42, and Section 5.6.2.3 on page 44</li></ul> <p><b>Chapter 6</b></p> <ul style="list-style-type: none"><li>■ Added the "Installing a USB 3.0 Camera" section as new Chapter 6. Moved chapters 6 - 9 to chapters 7 - 10.</li></ul> <p><b>Chapter 7</b></p> <ul style="list-style-type: none"><li>■ Added information about using IEEE 1394 cameras with Microsoft Windows 8 and 8.1 in Section 7.1 on page 67.</li></ul> <p><b>Chapter 8</b></p> <ul style="list-style-type: none"><li>■ Added drawings of the Camera Link camera connections in Section 8.3.2 on page 85.</li><li>■ Removed the aviator camera connection drawing in Section 8.3.3 on page 86.</li></ul> <p><b>Chapter 9</b></p> <ul style="list-style-type: none"><li>■ Removed Section 9.1 ("Acquiring Your First Images") and Section 9.2 ("Adjusting Image Quality"). Content of these sections can now be found in the online help of the pylon software.</li><li>■ Added instructions on how to open the online help of the pylon software.</li></ul> <p><b>Chapter 10</b></p> <ul style="list-style-type: none"><li>■ Added information about color enhancements.</li></ul>

Document Number	Date	Changes
AW00061109000	12 Nov 2015	<p><b>General</b></p> <ul style="list-style-type: none"> <li>■ Minor corrections and modifications throughout the manual.</li> <li>■ Updated to Basler pylon 5 software whenever applicable throughout the manual.</li> <li>■ Removed all precautions. Added references to the precautions in the individual camera User's Manuals.</li> <li>■ Moved and renamed Chapter 4 ("Uninstalling Old pylon Software") to Chapter 9 on <a href="#">page 71</a> ("Uninstalling or Changing the pylon Camera Software Suite"). Uninstalling old pylon software is no longer required before installing a newer version. Added generic information about uninstalling and changing pylon.</li> <li>■ Moved chapters 5 - 8 to chapters 4 - 7.</li> <li>■ Removed individual software installation procedures from Chapters 4 - 7. Using the new pylon installer, these procedures are self-explanatory.</li> </ul> <p><b>Chapter 2</b></p> <ul style="list-style-type: none"> <li>■ Moved Section 2.2 ("Warranty Precautions") to the title pages.</li> </ul> <p><b>Chapter 3</b></p> <ul style="list-style-type: none"> <li>■ Renamed Chapter 3 on <a href="#">page 4</a> to "Installing the Basler pylon Camera Software Suite".</li> <li>■ Removed Section 3.3 ("Software Features ..."). Information about software features is now displayed during pylon installation.</li> <li>■ Added a generic software installation procedure in Section 3.2 on <a href="#">page 4</a>.</li> </ul> <p><b>Chapter 5</b></p> <ul style="list-style-type: none"> <li>■ Included the dart USB 3.0 and pulse USB 3.0 camera series.</li> </ul> <p><b>Chapter 6</b></p> <ul style="list-style-type: none"> <li>■ Renamed "IEEE 1394 cameras" to "FireWire cameras" in accordance with the pylon installer.</li> </ul> <p><b>Chapter 7</b></p> <ul style="list-style-type: none"> <li>■ Included the beat Camera Link camera series.</li> <li>■ Updated instructions and screen shots related to the pylon CL Configurator in Section 7.5 on <a href="#">page 63</a>.</li> </ul> <p><b>Chapter 8</b></p> <ul style="list-style-type: none"> <li>■ Removed Section 8.1 ("Modifying Your Software Installation"). Content of this section can now be found in Chapter 9.</li> <li>■ Split Section 8.2 in two Sections: Section 8.1 and Section 8.2. Re-added the "Acquiring Your First Images" section (now Section 8.1) with revised and shortened instructions.</li> <li>■ Renamed Section 8.2 to "Configuring and Optimizing Your Camera".</li> </ul>

## Index

### A

addressing	
Auto IP (LLA) .....	25
DHCP .....	25
LLA .....	25
APIPA .....	33
Auto IP .....	33
auto IP .....	33
Auto IP (LLA)	
see LLA	
auto negotiation .....	11
automatic private IP addressing .....	33

### B

bandwidth optimization .....	69
------------------------------	----

### C

cables, conversion .....	52
cables, IEEE 1394 .....	52
camera description file .....	19
camera files for the frame grabber .....	59
CL Configurator .....	63
compatible chipset .....	7, 20
compatible network adapter .....	20
CPU interrupts .....	11

### D

device user ID .....	37
DHCP IP addressing .....	33
DHCP server .....	33
dll filename	
32-bit version .....	58

### E

electromagnetic interference .....	3
electrostatic discharge .....	3
EMI .....	3
ESD .....	3

### F

feature set .....	19
firewall .....	12
fixed IP address .....	27
frame grabber camera files .....	59

### I

image quality .....	69
incompatible network adapter .....	20
installation	
hardware .....	18, 40, 41, 42, 55, 62, 69
preparation .....	5, 43, 52, 57
interrupt moderation rate .....	11
IP address .....	33
fixed .....	27
persistent .....	25
temporary .....	34
IP configuration, camera .....	34
IP Configurator .....	34

### J

jumbo frames .....	11, 24
jumbo packets .....	24

### L

laptop computer .....	52
lens, suggested choice .....	5, 43, 52, 57
link-local address .....	33
LLA .....	33
see link local address	

### N

network adapter	
compatible .....	20
incompatible .....	20
recommended .....	20
network architectures, recommended .....	22
network switch .....	22, 24

**O**

online help .....	69
operating system .....	4
optimize image quality .....	69

**P**

peer-to-peer networking .....	22
pylon	
CL Configurator .....	63
IP Configurator .....	34
USB Configurator .....	49

**R**

receive descriptors .....	11
recommended network adapter .....	20
runtime redistributable packages .....	71

**S**

speed and duplex mode .....	11
static IP address .....	33
switches, network .....	22, 24
system requirements .....	4

**U**

uninstalling .....	71
USB 2.0 .....	43
USB Configurator .....	49