



*See the possibilities*

# *User Manual*

## ***GO-2400M-PGE*** ***GO-2400C-PGE***

*2.35M Digital Progressive Scan  
Monochrome and Color Camera*

*Document Version: 1.0*

*GO-2400-PGE\_Ver.1.0\_Aug.2016*

Thank you for purchasing this product.



Be sure to read this manual before use.

This manual includes important safety precautions and instructions on how to operate the unit. Be sure to read this manual to ensure proper operation.

# Contents

Notice.....	3	LUT (Lookup Table) .....	32
Warranty .....	3	To use the LUT function .....	32
Certifications.....	3	LUT values.....	32
Warning .....	3	Gamma Function .....	33
Usage Precautions .....	6	To use the gamma function .....	33
Features.....	7	Line Status.....	34
Parts Identification .....	8	Shading Correction .....	34
		Flat Shading.....	34
<b>Preparation.....</b>	<b>12</b>	Color Shading (GO-2400C-PGE only) .....	35
Preparation Process .....	12	To use the shading correction function .....	35
Step 1: Installing the Software (first time only).....	12	Binning Function.....	35
Step 2: Connecting Devices.....	13	ROI (Regional Scanning Function) .....	36
Step 3: Verifying the Camera's Network Connection		ROI Settings.....	36
Status.....	15	Video Send Mode .....	37
Step 4: Configuring Initial Settings for the Camera.....	15	Video Send Mode .....	37
Connecting to the Camera to Control Tool .....	15	To switch the video send mode .....	37
Configuring the Output Format.....	16	Multi ROI Mode.....	37
Configuring Exposure and External Trigger		Sensor Multi ROI Function .....	38
Settings.....	17	Sequence Trigger function .....	40
Control via External Triggers.....	18	Delayed Readout [Acquisition Transfer Start] .....	43
When Controlling the Exposure Time Using		ALC (Automatic Level Control) Function.....	43
Specified Exposure Times .....	18	To use the ALC function.....	43
When Controlling the Exposure Time using		Automatic gain level control .....	43
the Pulse Width of the Trigger Input Signal .....	19	Detailed Settings for Gain Auto	
Control Without External Triggers .....	20	(Automatic Gain Level Control) .....	44
When Controlling the Exposure Time Using		Counter and Timer Control Function	
Specified Exposure Times .....	20	(counter support only).....	45
When not Controlling the Exposure Time .....	20	Counter occurrence diagram .....	45
Step 5: Adjusting the Image Quality.....	20	Internal camera blocks .....	45
Adjusting the Gain .....	21	To use the counter function .....	46
Manual adjustment .....	21	Video Process Bypass Mode.....	46
Adjusting the White Balance		Differences in camera operation .....	46
(GO-2400C-PGE only) .....	21	To enable video process bypass mode.....	46
Manual white balance adjustment.....	21		
Automatic white balance adjustment .....	21	<b>Settings List.....</b>	<b>47</b>
Adjusting the Black Level.....	22	Feature Properties.....	47
Step 6: Configuring Various Other Settings .....	22	Settings.....	55
Step 7: Saving the Settings.....	22		
To save user settings .....	23	<b>Miscellaneous .....</b>	<b>57</b>
To load user settings.....	23	Troubleshooting .....	57
Basic Function Matrix .....	24	Specifications.....	58
		Frame Rate Reference .....	60
<b>Main Functions .....</b>	<b>25</b>	Spectral Response .....	60
GPIO (Digital Input/Output Settings).....	25	Dimensions .....	61
Valid Input/Output Combinations.....	25	User's Record .....	62
Acquisition Control (Image Acquisition Controls).....	26		
Changing the Frame Rate .....	26	<b>Index .....</b>	<b>63</b>
Maximum Frame Rate.....	26		
Maximum frame rate period formula .....	27		
Exposure Mode.....	27		
Trigger Control .....	28		
Shortest Repetition Period for Triggers.....	28		
When [Exposure Mode] is [Timed].....	28		
When [Exposure Mode] is [Trigger Width] .....	29		
During normal continuous operation (both			
[Exposure Mode] and [Trigger Mode]			
disabled) .....	29		
Event Control .....	30		
Event message occurrence diagram .....	30		
Internal camera blocks .....	30		
To use the event control function.....	31		
Gain Control.....	31		

## Notice

The material contained in this manual consists of information that is proprietary to JAI Ltd., Japan and may only be used by the purchasers of the product. JAI Ltd., Japan makes no warranty for the use of its product and assumes no responsibility for any errors which may appear or for damages resulting from the use of the information contained herein. JAI Ltd., Japan reserves the right to make changes without notice.

Company and product names mentioned in this manual are trademarks or registered trademarks of their respective owners.

## Warranty

For information about the warranty, please contact your factory representative.

## Certifications

### CE compliance

As defined by the Directive 2004/108/EC of the European Parliament and of the Council, EMC (Electromagnetic compatibility), JAI Ltd., Japan declares that GO-2400M-PGE and GO-2400C-PGE comply with the following provisions applying to its standards.

EN 61000-6-3 (Generic emission standard part 1)

EN 61000-6-2 (Generic immunity standard part 1)

### FCC

This equipment has been tested and found to comply with the limits for a Class B digital device, pursuant to Part 15 of the FCC Rules. These limits are designed to provide reasonable protection against harmful interference in a residential installation. This equipment generates, uses and can radiate radio frequency energy and, if not installed and used in accordance with the instructions, may cause harmful interference to radio communications. However, there is no guarantee that interference will not occur in a particular installation. If this equipment does cause harmful interference to radio or television reception, which can be determined by turning the equipment off and on, the user is encouraged to try to correct the interference by one or more of the following measures:

- Reorient or relocate the receiving antenna.
- Increase the separation between the equipment and receiver.
- Connect the equipment into an outlet on a circuit different from that to which the receiver is connected.
- Consult the dealer or an experienced radio/TV technician for help.

### Warning

**Changes or modifications to this unit not expressly approved by the party responsible for FCC compliance could void the user's authority to operate the equipment.**

## Supplement

The following statement is related to the regulation on “ Measures for the Administration of the control of Pollution by Electronic Information Products “ , known as “ China RoHS “ . The table shows contained Hazardous Substances in this camera.

 mark shows that the environment-friendly use period of contained Hazardous Substances is 15 years.

### 重要注意事项

#### 有毒，有害物质或元素名称及含量表

根据中华人民共和国信息产业部『电子信息产品污染控制管理办法』，本产品《有毒，有害物质或元素名称及含量表》如下。

部件名称	有毒有害物质或元素					
	铅 (Pb)	汞 (Hg)	镉 (Cd)	六价铬 (Cr (VI))	多溴联苯 (PBB)	多溴二苯醚 (PBDE)
电路板	×	○	○	○	○	○
螺丝	×	○	○	○	○	○
插座	×	○	○	○	○	○
.....	.....	.....	.....	.....	.....	.....

○：表示该有毒有害物质在该部件所有均质材料中的含量均在SJ/T11363-2006规定的限量要求以下。  
 ×：表示该有毒有害物质至少在该部件的某一均质材料中的含量超出SJ/T11363-2006规定的限量要求。  
 （企业可在此处、根据实际情况对上表中打“×”的技术原因进行进一步说明。）



#### 环保使用期限

电子信息产品中含有的有毒有害物质或元素在正常使用的条件下不会发生外泄或突变、电子信息产品用户使用该电子信息产品不会对环境造成严重污染或对基人身、财产造成严重损害的期限。

数字「15」为期限15年。

## Supplement

The following statement is related to the regulation on “ Measures for the Administration of the control of Pollution by Electronic Information Products “ , known as “ China RoHS “ . The table shows contained Hazardous Substances in this camera.

 mark shows that the environment-friendly use period of contained Hazardous Substances is 15 years.

### 重要注意事项

#### 有毒，有害物质或元素名称及含量表

根据中华人民共和国信息产业部『电子信息产品污染控制管理办法』，本产品《有毒，有害物质或元素名称及含量表》如下。

部件名称	有毒有害物质或元素					
	铅 (Pb)	汞 (Hg)	镉 (Cd)	六价铬 (Cr (VI))	多溴联苯 (PBB)	多溴二苯醚 (PBDE)
电路板	×	○	○	○	○	○
螺丝	×	○	○	○	○	○
插座	×	○	○	○	○	○
光学滤镜	×	○	×	○	○	○
.....	.....	.....	.....	.....	.....	.....

○：表示该有毒有害物质在该部件所有均质材料中的含量均在SJ/T11363-2006规定的限量要求以下。  
 ×：表示该有毒有害物质至少在该部件的某一均质材料中的含量超出SJ/T11363-2006规定的限量要求。  
 （企业可在此处、根据实际情况对上表中打“×”的技术原因进行进一步说明。）



#### 环保使用期限

电子信息产品中含有的有毒有害物质或元素在正常使用的条件下不会发生外泄或突变、电子信息产品用户使用该电子信息产品不会对环境造成严重污染或对基人身、财产造成严重损害的期限。

数字「15」为期限15年。

## Usage Precautions

### Notes on cable configurations

The presence of lighting equipment and television receivers nearby may result in video and audio noise. In such cases, change the cable configurations or placement.

### Notes on LAN cable connection

Secure the locking screws on the connector manually, and do not use a driver. Do not secure the screws too tightly. Doing so may wear down the screw threads on the camera. (Tightening torque: 0.147 Nm or less)

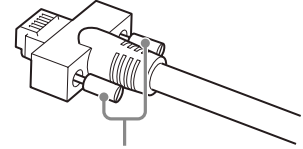

Secure manually.  
Do not secure too tightly.

### Notes on attaching the lens

#### Avoiding dust particles

When attaching the lens to the camera, stray dust and other particles may adhere to the sensor surface and rear surface of the lens. Be careful of the following when attaching the lens.

- Work in a clean environment.
- Do not remove the caps from the camera and lens until immediately before you attach the lens.
- To prevent dust from adhering to surfaces, point the camera and lens downward and do not allow the lens surface to come into contact with your hands or other objects.
- Always use a blower brush to remove any dust that adheres.  
Never use your hands or cloth, blow with your mouth, or use other methods to remove dust.

### Phenomena specific to CMOS image sensors

The following phenomena are known to occur on cameras equipped with CMOS image sensors. These do not indicate malfunctions.

- **Aliasing**  
When shooting straight lines, stripes, and similar patterns, vertical aliasing (zigzag distortion) may appear on the monitor.
- **Blooming**  
When strong light enters, more than the allowable amount of charge of the sensor element in the CMOS image sensor (pixel) and the charge is overflowing, enters into the surrounding pixels, and blooming may occur. However, this does not affect actual operation.
- **Fixed pattern noise**  
When shooting dark objects in high-temperature conditions, fixed pattern noise may occur throughout the entire video monitor screen.
- **Defective pixels**  
Defective pixels (white and black pixels) of the CMOS image sensor are minimized at the factory according to shipping standards. However, as this phenomenon can be affected by the ambient temperature, camera settings (e.g., high sensitivity and long exposure), and other factors, be sure to operate within the camera's specified operating environment.

### Notes on exportation

When exporting this product, please follow the export regulations of your country or region.

## Features

The GO-2400M-PGE/GO-2400C-PGE is an industrial progressive scan camera equipped with a 1/1.2-inch global shutter CMOS image sensor with 2.35 effective megapixels (1936 × 1216). The unit is compact and lightweight in design and is equipped with GigE Vision Ver. 1.1 interface.

❖ The GO-2400M-PGE produces monochrome output while the GO-2400C-PGE produces Bayer output.

### Compact and lightweight

The unit's compact (approx. 29 × 29 × 41.5 mm, excluding lens mount) and lightweight (approx. 46 g) design allows for easy assembly and installation.

### Gigabit Ethernet interface supporting GigE Vision Ver. 1.1

- High-speed transfer at up to 1 Gbps of uncompressed data, the ideal format for image processing.
- Connection of multiple cameras and computers supported through use of a switching hub, etc.
- Maximum cable length of 100 m.
- Support for IEEE802.af-compliant PoE (Power over Ethernet) allowing you to supply power to the camera via the LAN cable.

#### Note

Interface card or switching hub must support PoE. Alternatively, power can be supplied via the 6-pin connector using an optional +12 to +24V DC power supply.

### Output formats

You can choose from 8-bit, 10-bit, and 12-bit\* output for both monochrome and Bayer.

\* As the color camera cannot perform white balance when using 12-bit output, perform white balance on the application.

### High frame rate

The GO-2400M-PGE and GO-2400C-PGE are both capable of frame rates of up to 48.8 fps (8-bit format) for full 2.35-megapixel output. Even faster frame rates can be achieved when binning is utilized (GO-2400M-PGE only) or when a smaller ROI (region of interest) is specified.

### ALC (automatic level control) function

Combine the automatic gain control and automatic exposure control functions to allow handling of changes in various brightnesses.

### Variety of pre-process functions

- **LUT (lookup table)**  
For programmable control over gamma and contrast.
- **Gamma correction**  
Gamma can be set to 0.45, 0.60, or 1.0 (off).
- **Shading correction (flat field and color shading)**  
Non-uniformity (i.e., shading) in the amount of light generated by the lens and lighting equipment can be corrected.
- **Bayer white balance (GO-2400C-PGE only)**  
White balance can be automatically adjusted continuously. It can also be adjusted manually using R, and B gain.

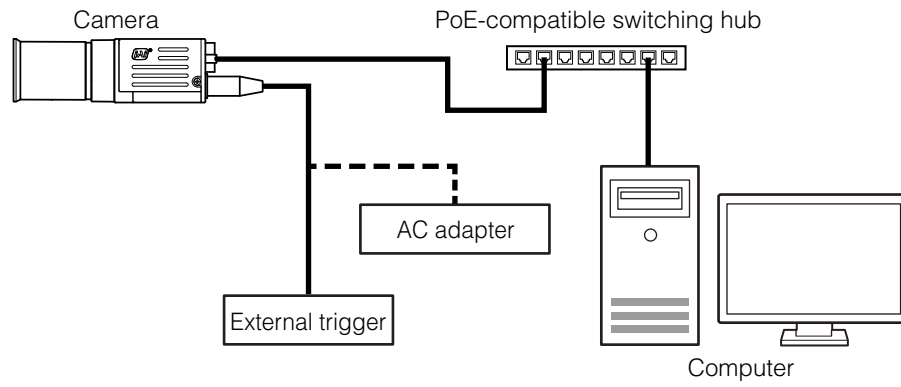
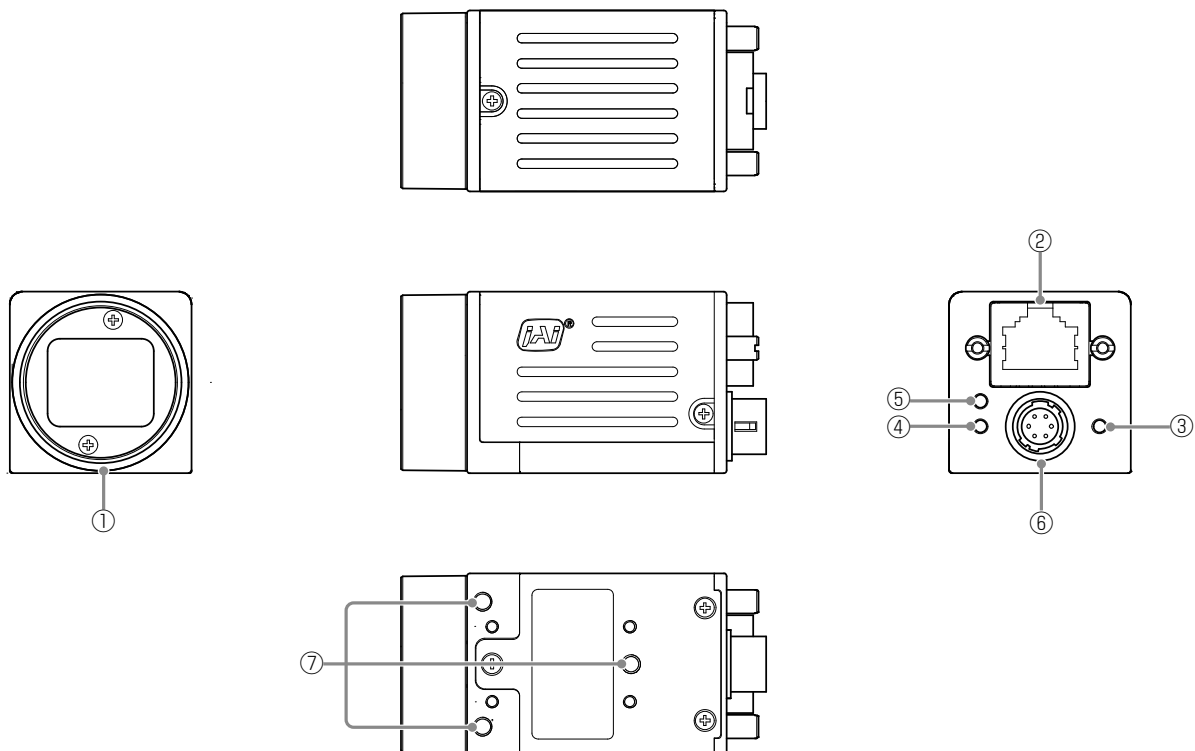
**Connection example:****Parts Identification****① Lens mount (C-mount)**

Mount a C-mount lens, microscope adapter, etc. here.

- ❖ Before mounting a lens, be sure to refer to “Step 2: Connecting Devices” (page 13) and confirm the precautions for attaching a lens and the supported lens types.



## ② RJ-45 connector

Connect a Gigabit Ethernet compatible LAN cable (Category 5e or higher, Category 6 recommended) here.

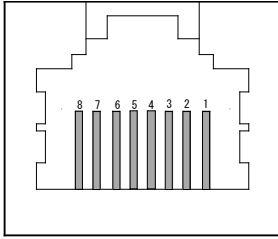

Pin No.	Input/output	Description
1	In/Out	MX1+ (DA+)
2	In/Out	MX1- (DA-)
3	In/Out	MX2+ (DB+)
4	In/Out	MX3+ (DC+)
5	In/Out	MX3- (DC-)
6	In/Out	MX2- (DB-)
7	In/Out	MX4+ (DD+)
8	In/Out	MX4- (DD-)

## ③ Power/trigger LED

Indicates the power and trigger input status.

## ④ ACT LED

Indicates the GigE network status.

## ⑤ LINK LED

Indicates whether the GigE network connection is 1000BASE-T or 100BASE-TX.

❖ The specifications described in this manual, such as those for frame rate and trigger frequency, cannot be met when using a 100BASE-TX connection.

## LED status and camera status

LED	Light	Status
Power / trigger LED	● Lit amber	Camera initializing.
	● Lit green	Camera in operation.
	✱ Blinking green	During operation in trigger mode, trigger signals are being input. ❖ The blinking interval is not related to the actual input interval of the external trigger.
ACT LED	● Lit amber	GigE network communication not established.
	✱ Blinking amber	GigE network communication in progress.
LINK LED	● Lit green	1000BASE-T connection established.
	✱ Blinking green	100BASE-TX connection established.

## ⑥ DC IN / trigger IN connector (6-pin round)

Connect the cable for a power supply (optional) or for DC IN / trigger IN here.

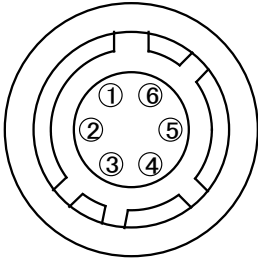

HR-10A-7R-6PB (73) (Hirose Electric or equivalent)

Pin No.	Input/output	Signal	Description
1		DC IN	+12 to +24 V
2	In	Opto IN 1	GPIO 5
3	Out	Opto OUT 1	GPIO 1
4	Out	Opto OUT 2	GPIO 2
5		Opto Common	
6		GND	

## Recommended external input circuit diagram (reference example)

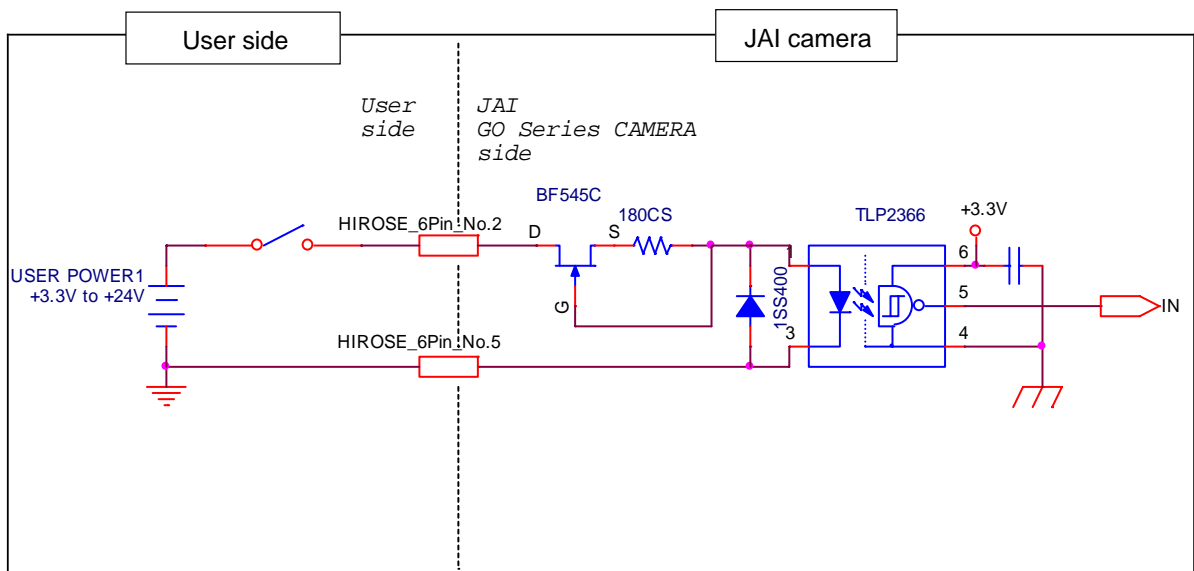

Recommended external output circuit diagram (reference example)

Standard circuit diagram example

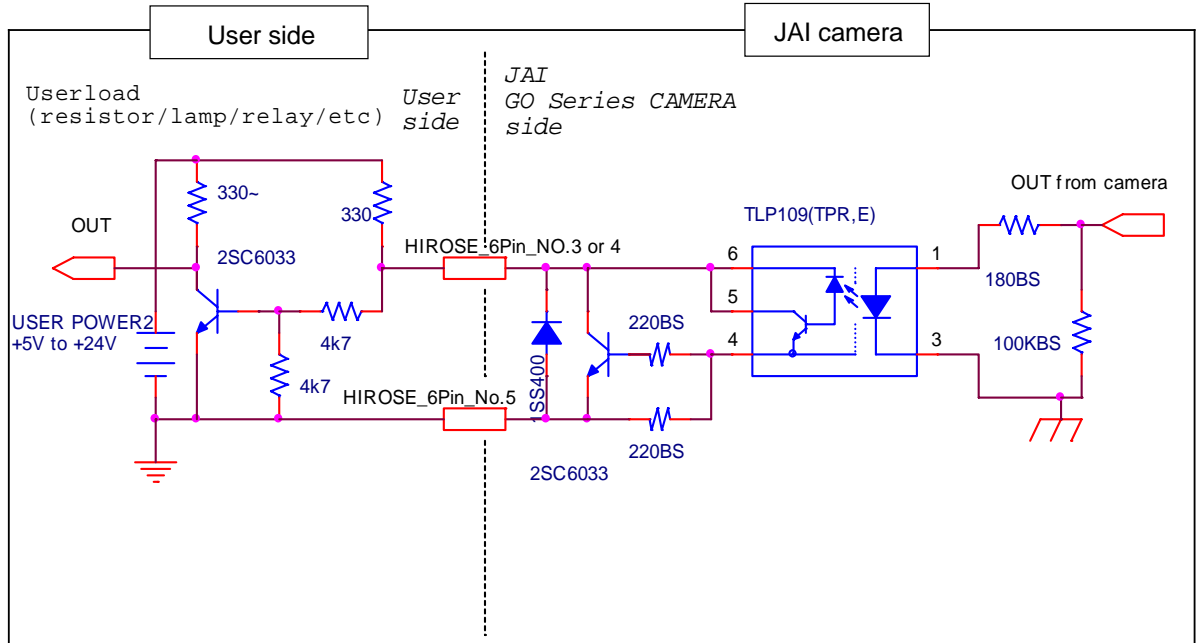

Characteristics of the recommended circuits for Opto OUT

OUTPUT LINE RESPONSE TIME

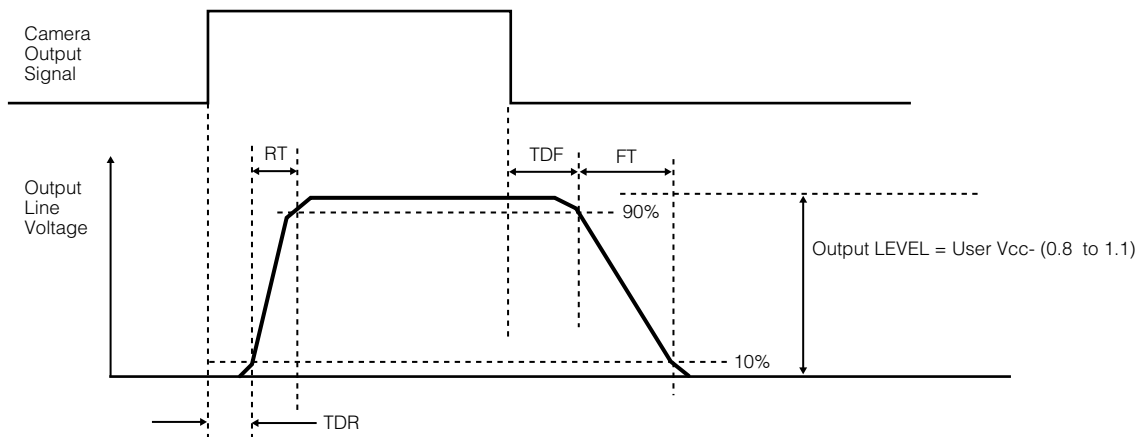

⑦ Camera locking screw holes (M3, 3 mm depth)

Use these holes when attaching an MP-43 tripod adapter plate (optional) or mounting the camera directly to a wall or other structural system.

- ❖ The smaller holes (×4) are M2 with a depth of 3 mm.

# Preparation

## Preparation Process

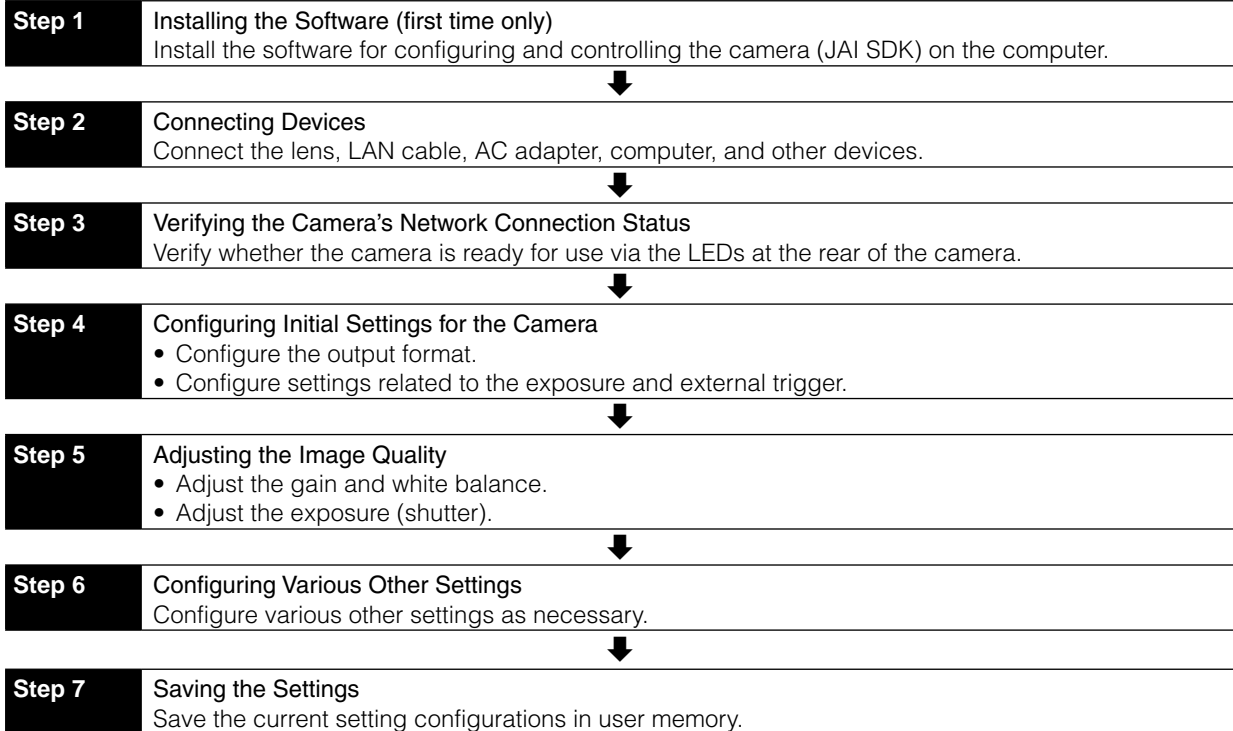

## Step 1: Installing the Software (first time only)

When using the camera for the first time, install the software for configuring and controlling the camera (JAI SDK) on the computer.

❖ When you install JAI SDK, JAI Camera Control Tool will also be installed.

### 1 Download the “JAI - Getting Started Guide” and JAI SDK from the JAI website.

URL: <http://www.jai.com/en/support/download-jai-software>

### 2 Refer to the “JAI - Getting Started Guide,” and install JAI SDK on the computer.

The computer will restart when installation is complete.

#### Note

When the JAI SDK is installed, a camera driver for the GigE interface is also part of the default installation. This GigE Vision Filter Driver is added to every NIC/port on the host computer. As the driver is also added to the NIC/port for Internet connection, it may, on some systems, affect Internet access speed. If you think your Internet speed is affected, configure the following settings to disable the filter driver on that port.

- 1 Open [Control Panel] → [Network and Internet] → [Connect to a network], and right-click the port used for Internet connection to open the properties dialog box.

- ② Clear the [JAI GigE Vision Filter Driver] checkbox, and save.

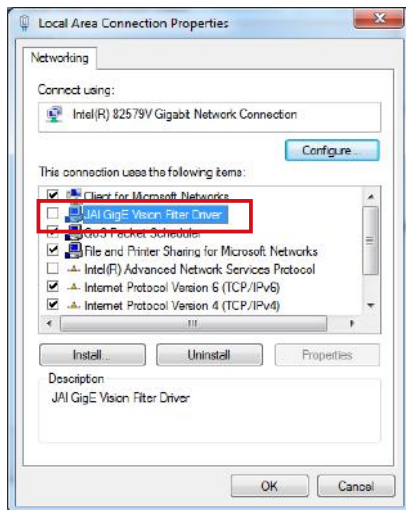

## Step 2: Connecting Devices

Connect the lens, LAN cable, AC adapter, and other devices.  
Attach the lens in a clean environment to prevent dust from adhering to the unit.

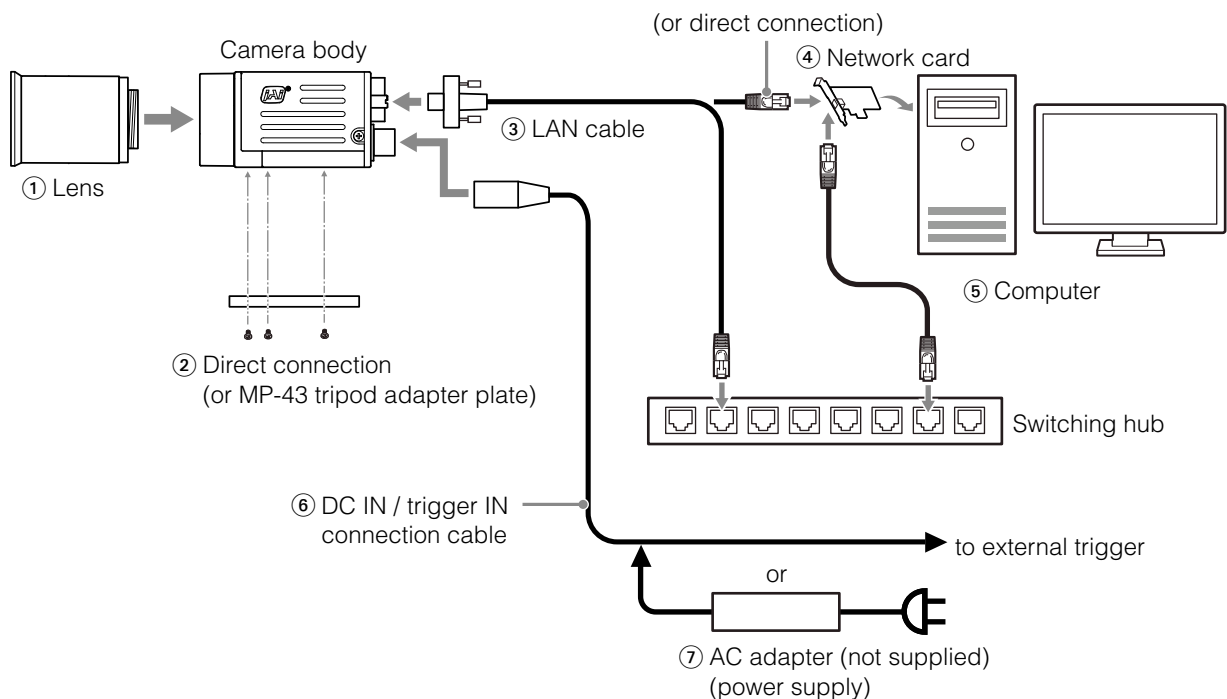

### ① Lens

- C-mount lenses with lens mount protrusions of 9 mm or less can be attached.

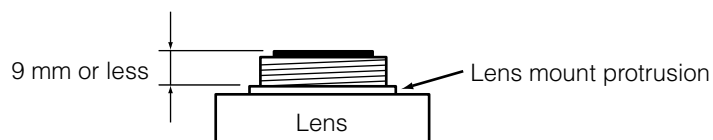

- The diagonal of the camera's CMOS image sensor is 13.4 mm, which is larger than the 11 mm size of standard 2/3-inch lenses. To prevent vignetting and to obtain the optimal resolution, use a lens that will cover the 13.4 mm diagonal. Some lens manufacturers offer lenses with a 13.4 mm format. If not, a 1-inch lens is recommended.

**Caution**

- The maximum performance of the camera may not be realized depending on the lens.
- Attaching a lens with a mount protrusion of 9.1 mm or longer may damage the lens or camera.

**Note**

The following formula can be used to estimate the focal length.

focal length =  $WD / (1 + W/w)$

WD: Working distance (distance between lens and object)

W: Width of object

w: Width of sensor (11.3 mm on this camera)

**② Direct connection (or MP-43 tripod adapter plate)**

When mounting the camera directly to a wall or other device, use screws that match the camera locking screw holes on the camera. (Large: M3, small: M2, depth: 3 mm)

Use the supplied screws to attach the tripod adapter plate.

**Caution**

For heavy lenses, be sure to support the lens itself. Do not use configurations in which its weight is supported by the camera.

**③ LAN cable**

Connect a LAN cable to the RJ-45 connector.

- Use a LAN cable that is Category 5e or higher (Category 6 recommended).
- When supplying power via PoE, connect to a PoE-compatible switching hub or a PoE-compatible network card.
- Refer to the specifications of the cable for details on its bend radius.

**Caution**

Secure the locking screws on the connector manually, and do not use a driver. Do not secure the screws too tightly. Doing so may wear down the screw threads on the camera. (Tightening torque: 0.147 Nm or less)

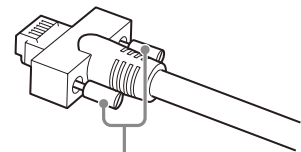

Secure manually.  
Do not secure too tightly.

**④ Network card**

Install this in the computer that will be used to configure and operate the camera.

As the GO-2400-PGE supports PoE, you can also use PoE-compatible network cards.

Refer to the instruction manual of the network card, and configure settings on the computer as necessary.

**⑤ Computer**

Use a computer that meets the following requirements.

**Operating system (OS):**

Microsoft Windows 7/8 32-bit/64-bit edition

**CPU:** Intel Core i3 or higher

**Memory:**

Windows 7/8 32-bit edition: DDR3, 4 GB or higher

Windows 7/8 64-bit edition: DDR3, 8 GB or higher

**Graphics card:** PCI-Express 3.0 or higher

**Network card:** We recommend using a network card that uses an Intel chip.

**⑥ DC IN / trigger IN connection cable****⑦ AC adapter (power supply) (if necessary)**

Connect the AC adapter and the round connector of the connection cable to the DC IN / trigger IN connector on the camera.

- ❖ The AC adapter is not required when using PoE.

## Step 3: Verifying the Camera's Network Connection Status

When power is supplied to the camera while the necessary equipment is connected, the power / trigger LED and ACT LED at the rear of the camera light amber, and initialization of the camera starts. When initialization is complete, the power / trigger LED lights green. The ACT LED and LINK LED will light or blink according to the network status.

Verify whether power is being supplied to the camera and whether the camera is connected to the network by checking the rear LEDs.

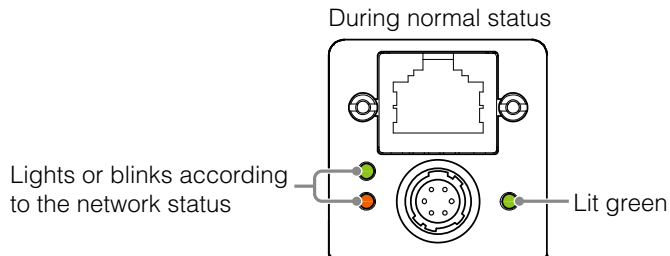

- ❖ For details on how to read the LEDs, see “LED status and camera status” (page 9) in the “Parts Identification” section.

### Note

Initialization of the camera will not complete unless it is connected to the network. If the power / trigger LED does not switch to green within minutes of supplying power, check the LAN cable and other connections. After initialization is completed once, the power / trigger LED will remain green, even if the network is disconnected.

## Step 4: Configuring Initial Settings for the Camera

Start Control Tool, connect the camera to the network, and configure initial settings for the output format, exposure, external trigger, etc.

### Connecting to the Camera to Control Tool

- 1** Start JAI Control Tool.  
Cameras connected to the network are detected and displayed in a window. If they do not appear, right-click inside the window and select [Search for Cameras].
- 2** Select the camera you want to configure.
- 3** Check that the settings of the selected camera are displayed.

## Configuring the Output Format

Configure the size, position, and pixel format of the images to be acquired. The factory settings are as follows. Change the settings as necessary.

### Factory default values

	Item	Default value
Image Format Control	Width	1936 (pixels)
	Height	1216 (pixels)
	Offset X (horizontal position)	0 (pixels)
	Offset Y (vertical position)	0 (pixels)
	Pixel Format	GO-2400M-PGE: 8 Bit Monochrome GO-2400C-PGE: 8 Bit Bayer RG



❖ You can specify the image acquisition area. For details, see “ROI (Regional Scanning Function)” (page 36).

## 1 Select the [Feature Properties] tab, and select the item you want to configure under [Image Format Control].

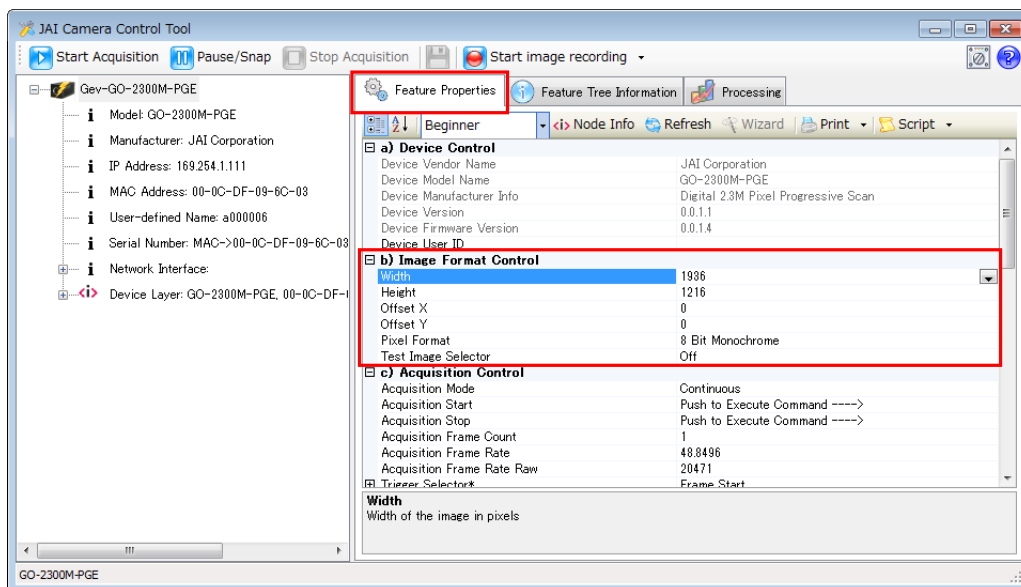
 when a configurable item is selected.



### Note

Settings can only be changed when image acquisition on the camera is stopped. If an item is grayed out and  does not appear even when you select it, click  (Stop Acquisition) to stop image acquisition.

## 2 Click and change the setting value.

Example: When changing [Width]

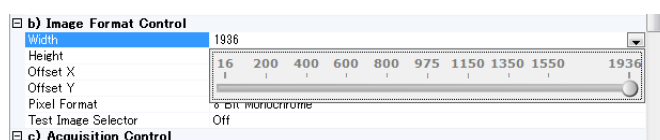



### Example: When changing [Pixel Format]

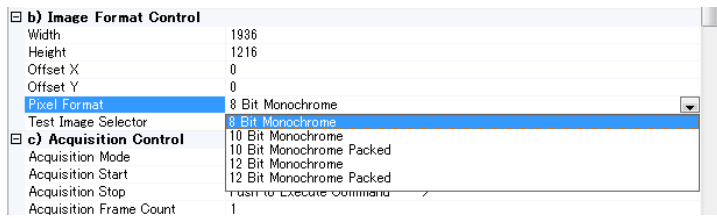

#### Note

Direct entry of numerical and text values is possible for some setting items.

## Configuring Exposure and External Trigger Settings

Configure settings related to exposure control methods and trigger control.

The factory settings are as follows. Change settings as necessary, according to the intended purpose or application.

### Factory default values

Item	Default value
Trigger Selector (trigger operation)	Frame Start
Trigger Mode	Off
Trigger Source (trigger signal source)	Line 5 - Optical In 1
Trigger Activation (trigger polarity)	Rising Edge (rising edge of input signal)
Exposure Mode	Timed (control via exposure time)
Exposure Time	20363 (μs)
Exposure Auto*	Off

\* This item is only enabled when [Exposure Mode] is set to [Timed].

### Caution

When [Exposure Mode] is set to [Off], [Trigger Mode] cannot be set to [On]. Other settings may also be restricted depending on the exposure mode, so be sure to set the exposure mode before configuring the trigger settings.

Adjusting Packet Size: With [Trigger Mode] set to [Off] and [Exposure Mode] set to [Continuous], clicking the (Start Acquisition) button should produce a live image. If, however, you can only see a black screen, it may be the result of the packet size setting in the camera being larger than the packet size setting in the GigE NIC or switch. To correct the problem, you can either reduce the [Packet Size] setting to a value less than 1500 in the JAI Control Tool (under [Transport Layer Control] / [Stream Channel Selector], or set your NIC or switch to support "Jumbo Frames." This setting is typically found in the Advanced Adapter Settings for the NIC or switch which can be accessed through the Device Manager on your PC.

Configure the settings by expanding [Acquisition Control] and configuring the following items.

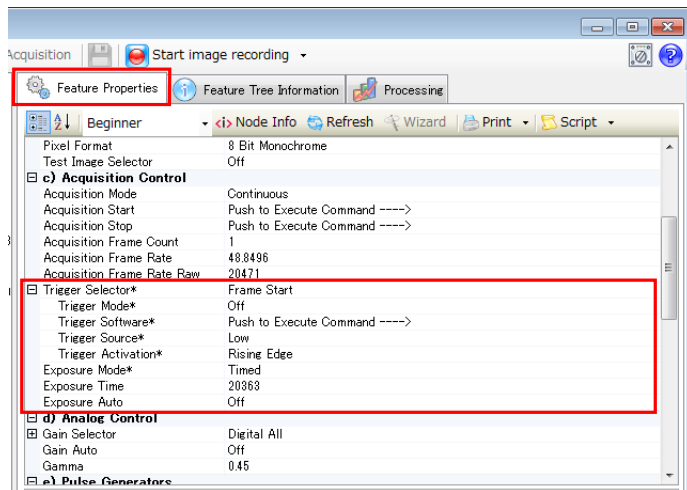

### Caution

Settings can only be configured when image acquisition on the camera is stopped. If an item is grayed out and the setting cannot be changed, stop image acquisition beforehand.

## Control via External Triggers

### When Controlling the Exposure Time Using Specified Exposure Times

Configure the settings as follows.

Item	Setting value / selectable range
Trigger Selector (trigger operation)	Frame Start
Trigger Mode	On
Trigger Source (trigger signal source)	Any
Trigger Activation (trigger polarity)	Rising Edge (rising edge of input signal), Falling Edge (falling edge of input signal)
Exposure Mode	Timed (control via exposure time)
Exposure Time	38 to 7999892 ( $\mu\text{s}$ ) (1 $\mu\text{s}/\text{step}$ )* <sup>1</sup>
Exposure Auto	Off, Continuous

\* 1 The maximum value for [Exposure Time] varies depending on the value configured for the [Acquisition Frame Rate Raw] setting.

Max. value for [Exposure Time] = [Acquisition Frame Rate Raw] value - 177  $\mu\text{s}$

The minimum value will differ depending on the [Pixel Format] setting value.

**1** Set [Exposure Mode] to [Timed].  
([Timed] is the default setting.)

**2** Specify the exposure time in [Exposure Time].

The setting value for the exposure time can only be changed when [Exposure Auto] is set to [Off].  
If [Exposure Auto] is set to [Continuous], temporarily set it to [Off] before changing the exposure time.

**3** Set [Trigger Selector] to [Frame Start].  
([Frame Start] is the default setting.)

- 4** Set [Trigger Mode] to [On].
- 5** If necessary, change the [Trigger Source], [Trigger Activation], and [Exposure Auto] settings.

### When Controlling the Exposure Time using the Pulse Width of the Trigger Input Signal

Configure the settings as follows.

Item	Setting value / selectable range
Trigger Selector (trigger operation)	Frame Start
Trigger Mode	On
Trigger Source (trigger signal source)	Any
Trigger Activation (trigger polarity)	Level High (high-level duration), Level Low (low-level duration)
Exposure Mode	Trigger Width (control via trigger width)

- 1** Set [Exposure Mode] to [Trigger Width] .  
When you select [Trigger Width], [Trigger Mode] will automatically be set to [On].
- 2** Set [Trigger Selector] to [Frame Start].  
([Frame Start] is the default setting.)
- 3** If necessary, change the [Trigger Source] and [Trigger Activation] settings.

### Other controls

In addition to exposure time, the following can also be controlled by external triggers. Select these control operations in [Trigger Selector].

[Trigger Selector] setting	Description
Acquisition Start	Start image acquisition.
Acquisition End	Stop image acquisition.
Acquisition Transfer Start	Output acquired images at a specified timing. (Up to 7 frames for 8-bit, and up to 3 frames for 10-/12-bit.)

## Control Without External Triggers

### When Controlling the Exposure Time Using Specified Exposure Times

Configure the settings as follows.

Item	Setting value / selectable range
Trigger Selector (trigger operation)	Frame Start
Trigger Mode	Off
Exposure Mode	Timed (control via exposure time)
Exposure Time	38 to 7999892 ( $\mu$ s) (1 $\mu$ s/step)*1
Exposure Auto	Off, Continuous

\*1 The maximum value for [Exposure Time] varies depending on the value configured for the [Acquisition Frame Rate Raw] setting.

Max. value for [Exposure Time] = [Acquisition Frame Rate Raw] value - 177  $\mu$ s

The minimum value will differ depending on the [Pixel Format] setting value.

- 1** Set [Exposure Mode] to [Timed].  
([Timed] is the default setting.)
- 2** Specify the exposure time in [Exposure Time].  
The setting value for the exposure time can only be changed when [Exposure Auto] is set to [Off].  
If [Exposure Auto] is set to [Continuous], temporarily set it to [Off] before changing the exposure time.
- 3** Set [Trigger Mode] to [On].
- 4** If necessary, change the [Exposure Auto] setting.

### When not Controlling the Exposure Time

Configure the settings as follows.

Item	Setting value / selectable range
Exposure Mode	Off

The exposure will be performed with an exposure time equal to 1 / frame rate.

## Step 5: Adjusting the Image Quality

Adjust the image quality using the gain and white balance (GO-2400C-PGE only) functions.

### To adjust the image quality

The display level must be changed from [Beginner] to [Guru].

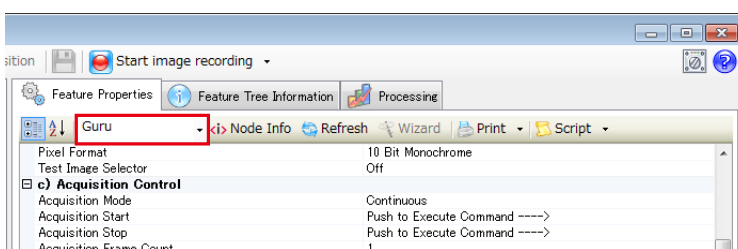

---

## Adjusting the Gain

Adjust the sensitivity via the analog gain (i.e., master gain).

❖ For details on gain control, see “Gain Control” (page 31) in the “Main Functions” section.

### ■ Manual adjustment

- 1** Expand [Analog Control], and set [Gain Auto] to [Off].  
([Off] is the default setting.)
- 2** Configure the gain.
  - 1** Expand [Analog Control], and select the gain you want to configure in [Gain Selector].
    - For the GO-2400M-PGE, only [Analog All] (master gain) can be configured.
    - For the GO-2400C-PGE, [Analog All] (master gain), [Digital Red] (digital R gain), and [Digital Blue] (digital B gain) can be configured individually.
  - 2** Configure the gain value in [Gain].
    - [Digital All] (master gain) can be set to a value from x1 to x16 (0 dB to +24 dB) the analog gain value. The resolution is set in x0.01 steps (0.05 dB to 0.08 dB depending on the setting value). Values are configured by multipliers. For example, the values set for x1 and x16 are 100 and 1600 respectively.
    - For the GO-2400C-PGE, the [Digital Red] (digital R gain) and [Digital Blue] (digital B gain) can be set to a value from x0.45 to x5.62 (–7 dB to +15 dB) the [Digital All] (master gain) value. The resolution is set in 0.1 dB steps. Specify 0 for 0 dB, negative values for settings below 0, and positive values for settings above 0.

---

## Adjusting the White Balance (GO-2400C-PGE only)

Adjust the white balance using R and B gain. The white balance can also be adjusted automatically.

### ■ Manual white balance adjustment

- 1** Expand [Analog Control], and set [Balance White Auto] to [Off].  
([Off] is the default setting.)
- 2** Select the gain to configure in [Gain Selector], and set the gain value in [Gain].

### ■ Automatic white balance adjustment

- 1** Place a white sheet of paper or similar object under the same lighting conditions as the intended subject, and zoom in to capture the white.  
White objects near the subject, such as a white cloth or wall, can also be used.  
Be sure to prevent the high-intensity spot lights from entering the screen.
- 2** Select the [Balance White Auto] tab, and click [Continuous] or [Once] depending on your intended application.  
The white balance is automatically adjusted.

## Adjusting the Black Level

- 1 Expand [Analog Control], and select the black level you want to configure in [Black Level Selector].

For the GO-2400M-PGE, only [Digital All] (master black) can be configured.

For the GO-2400C-PGE, [Digital All] (master black), [Digital Red] (digital R), and [Digital Blue] (digital B) can be configured individually.

- 2 Specify the adjustment value in [Black Level].

## Step 6: Configuring Various Other Settings

See “Settings List” (page 47) and configure settings as necessary.

## Step 7: Saving the Settings

The setting values configured in Control Tool will be deleted when the camera is turned off. By saving current setting values to user memory, you can load and recall them whenever necessary. You can save up to three sets of user settings (User Set1 to 3) in the camera.

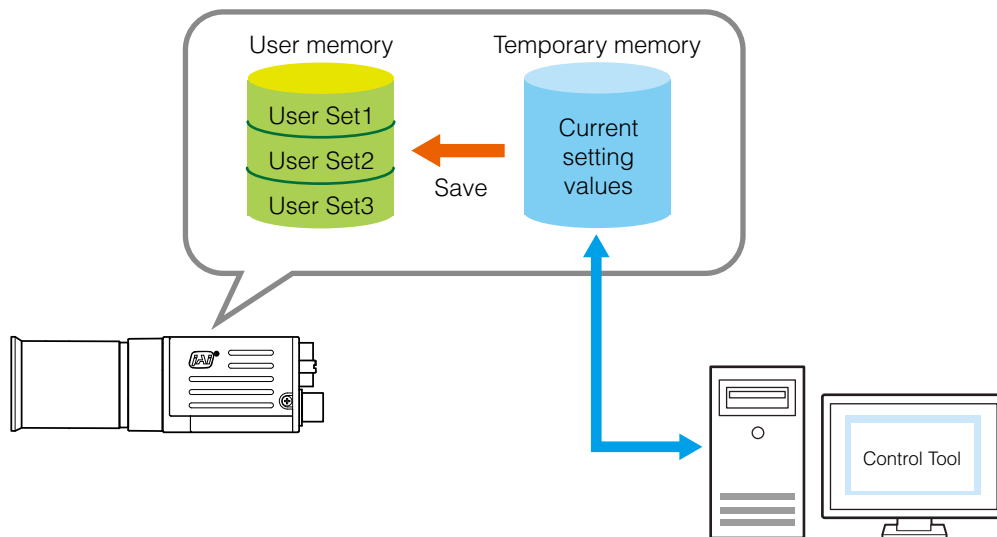

### Note

Changes to settings are not saved to the computer (Control Tool).

## ■ To save user settings

- 1 Stop image acquisition.
- 2 Expand [User Set Control], and select the save destination ([User Set1] to [User Set3]) in [User Set Selector].

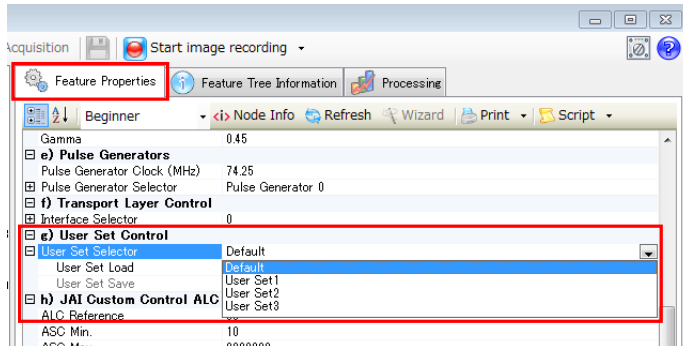

### Note

The factory default setting values are stored in [Default] and cannot be overwritten.

### Caution

Settings can only be saved when image acquisition on the camera is stopped.

- 3 Select [User Set Save], and click [Execute 'User Set Save' Command].

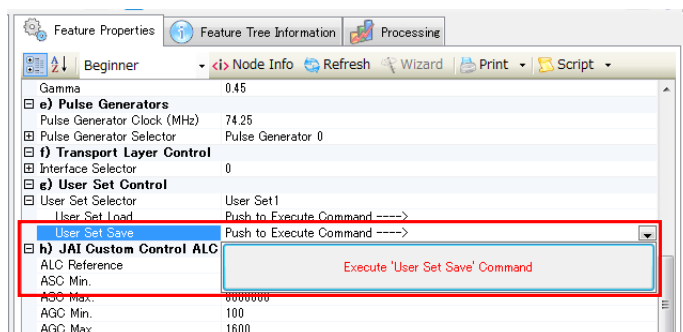

The current setting values are saved as user settings.

## ■ To load user settings

- 1 Stop image acquisition.  
User settings can only be loaded when image capture on the camera is stopped.
- 2 Select the settings to load (User Set1 to User Set3) in [User Set Selector].
- 3 Select [User Set Load], and click [Execute 'User Set Load' Command].  
The selected user settings are loaded.

## Basic Function Matrix

The combinations of settings for the basic functions that can be used together are as follows.

Exposure Mode	Frame Start Trigger	Binning Vertical* <sup>1</sup>	Binning Horizontal* <sup>1</sup>	Exposure Time	ROI	Balance White Auto* <sup>2</sup>	Gain Auto	Exposure Auto	Video Send Mode		
									Multi ROI	Trigger Sequence Mode	Command Sequence Mode
Off	Off	1 × 1 (Off)		x	○	○	○	x	○	x	x
		1 × 2		x	○	○	○	x	○	x	x
		2 × 1		x	○	○	○	x	○	x	x
		2 × 2		x	○	○	○	x	○	x	x
Timed	Off	1 × 1 (Off)		○	○	○	○	○	○	x	○
		1 × 2		○	○	○	○	○	○	x	○
		2 × 1		○	○	○	○	○	○	x	○
		2 × 2		○	○	○	○	○	○	x	○
Timed (EPS)	On	1 × 1 (Off)		○	○	○	○	x	○	○	○
		1 × 2		○	○	○	○	x	○	○	○
		2 × 1		○	○	○	○	x	○	○	○
		2 × 2		○	○	○	○	x	○	○	○
Trigger Width	On	1 × 1 (Off)		x	○	○	○	○	○	x	x
		1 × 2		x	○	○	○	○	○	x	x
		2 × 1		x	○	○	○	○	○	x	x
		2 × 2		x	○	○	○	○	○	x	x

\*1 Operates only on the GO-2400M-PGE

\*2 Operates only on the GO-2400C-PGE



# Main Functions

## GPIO (Digital Input/Output Settings)

The camera is equipped with GPIO (general-purpose input/output) functions for generating and using combinations of triggers and other necessary signals within the camera and of signals output from the camera to the system such as those used for lighting equipment control.

### Valid Input/Output Combinations

The following signals can be used as sources for each output destination (Trigger Selector, Line Selector, Pulse Generator Selector).

You can also connect two different sources to NAND paths in the GPIO and reuse the signal generated there as a source for a different selector.

The combinations of source signals and output destinations are indicated in the following.

Selector (Cross point switch output)		Output destination											
		Trigger Selector				Line Selector						Pulse Generator Selector	
		Acquisition Start	Acquisition Stop	Frame Start	Transfer Start	Line2 OPT Out 1 (GPIO 1)	Line3 OPT Out 2 (GPIO 2)	Time Stamp Reset	NAND 0 In 1	NAND 0 In 2	NAND 1 In 1	NAND 1 In 2	Pulse Generator 0
Signals to use as output	LOW	○	○	○	○	○	○	○	○	○	○	○	○
	HIGH	○	○	○	○	○	○	○	○	○	○	○	○
	Line5 OPT 1 In	○	○	○	○	○	○	○	○	○	○	○	○
	NAND 0 Out	○	○	○	○	○	○	○	×	×	○	○	○
	NAND 1 Out	○	○	○	○	○	○	○	○	○	×	×	○
	Pulse Generator 0	○	○	○	○	○	○	○	○	○	○	○	×
	User Output 0	○	○	○	○	○	○	○	○	○	○	○	○
	User Output 1	○	○	○	○	○	○	○	○	○	○	○	○
	Software Trigger	○	○	○	○	×	×	○	×	×	×	×	×
	Action 1	○	○	○	○	×	×	×	×	×	×	×	○
	Action 2	○	○	○	○	×	×	×	×	×	×	×	○
	FVAL	×	×	×	×	○	○	○	○	○	○	○	○
	LVAL	×	×	×	×	×	×	○	×	×	×	×	○
	Exposure Active	×	×	×	×	○	○	○	○	○	○	○	○
	Frame Trigger Wait	×	×	×	×	○	○	○	○	○	○	○	○
	Frame Active	×	×	×	×	○	○	○	○	○	○	○	○
	Acquisition Trigger Wait	×	×	×	×	○	○	○	○	○	○	○	○
		Trigger Source				Line Source						Pulse Generator Clear Source	
		Use											

□ : Indicates default values for each selector. “Factory default values” (page 17) shows the default values for [Frame Start].

## Acquisition Control (Image Acquisition Controls)

Perform operations and configure settings related to image acquisition in [Acquisition Control].

The following acquisition modes are available on the camera.

Acquisition Mode	Description
Single Frame	Acquire a single frame when the [Acquisition Start] command is executed.
Multi Frame	Acquire the number of frames specified in [Acquisition Frame Count] when the [Acquisition Start] command is executed.
Continuous	Acquire images continuously until the [Acquisition Stop] command is executed.

### Changing the Frame Rate

When [Trigger Mode] is disabled, you can change the frame rate in [Acquisition Frame Rate].

#### Note

- The shortest frame period varies depending on the ROI, pixel format, and binning mode selected. The longest frame period is 0.125 Hz (8 sec.).
- When [Trigger Mode] is enabled, the [Acquisition Frame Rate] setting is disabled.

### Maximum Frame Rate

The maximum frame rate is as follows depending on the sensor's scanning range and the GigE bandwidth.

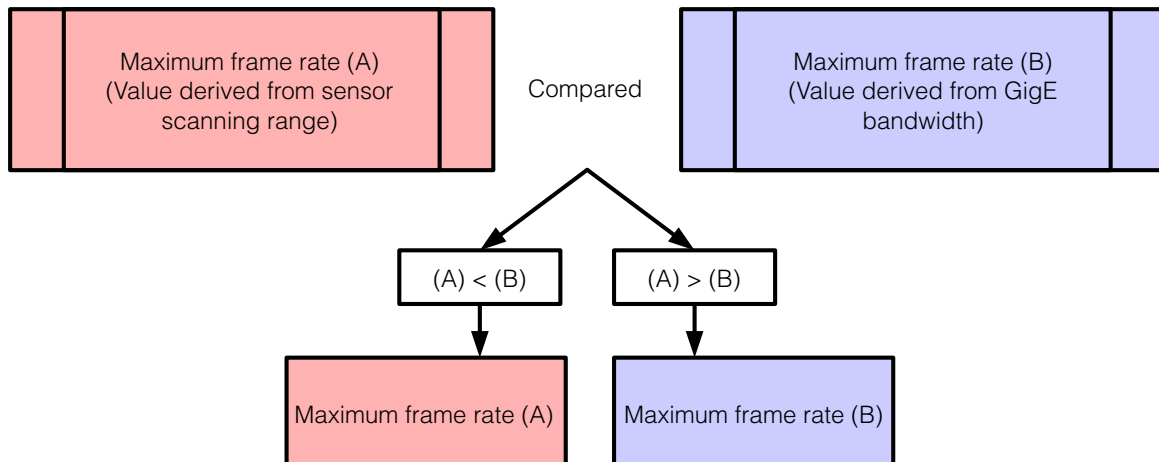

## Maximum frame rate period formula

- <sensor output max. frame rate>
  - During [Continuous] mode:  $1 / ((\text{Height}_s + 40) \times \text{Hperiod})$
  - During [Trigger Mode]:  $1 / (\text{Exposure Time}[\text{sec}] + (\text{Height}_s + 40) \times \text{Hperiod})$
- <GigE output bandwidth max. frame rate> =  $920 \times 1000000 / (\text{Height}_g \times \text{Width}_g \times \text{Pack value})$

max. frame rate (unit: fps) =  $\text{Min}^{*3} (\text{<sensor output max. frame rate>, <GigE output bandwidth max. frame rate>})$

Pixel Format	Binning	User settings		Height_s* <sup>1</sup>	Height_g* <sup>2</sup>	Width_g* <sup>2</sup>	H period	Pack value	Maximum frame rate (fps)
		Height	Width						
8-bit	B.V&B.H 1 (Off)	1216	1936	1216	1216	1936	$12.4445 \times 10^{-6}$	8	48.8
	B.V 2 (On)	608	968	1216	608	1936			64
	B.H 2 (On)	1216	1936	1216	1216	968			64
	B.V & B.H 2 (On)	608	968	1216	608	968			64
10-/12-bit	B.V & B.H 1 (Off)	1216	1936	1216	1216	1936	$24.2425 \times 10^{-6}$	16	24.4
	B.V 2 (On)	608	968	1216	608	1936			32.8
	B.H 2 (On)	1216	1936	1216	1216	968			32.8
	B.V & B.H 2 (On)	608	968	1216	608	968			32.8
10-/12-bit packed	B.V & B.H 1 (Off)	1216	1936	1216	1216	1936	$24.2425 \times 10^{-6}$	12	32.6
	B.V 2 (On)	608	968	1216	608	1936			32.8
	B.H 2 (On)	1216	1936	1216	1216	968			32.8
	B.V & B.H 2 (On)	608	968	1216	608	968			32.8

\* The values during [Continuous]

\*1 Height\_s: Line scanned by the sensor.

\*2 Height\_g, Width\_g: Height and width of output streams.

\*3 Minimum value (the smaller value is enabled).

### Caution

Although the maximum frame rate value is determined by the GigE bandwidth range, when ROI is configured, the frame rate cannot exceed the sensor output's allowable frame rate value.

## Exposure Mode

The following exposure modes are available on the camera.

Exposure Mode	Description
Off	Exposure control is not performed (free-running operation).
Timed	Mode in which control is performed using exposure time. Acquire images using an exposure time configured beforehand on an external trigger.
Trigger Width	Mode in which control of the exposure time is performed using the pulse width of the trigger input signal. The exposure time will be the same as the pulse width of the trigger input signal. This allows long exposure.

- ❖ The settings for exposure control and triggers are related to each other. Be sure to configure the settings described in "Configuring Exposure and External Trigger Settings" (page 17).

## Trigger Control

The camera allows the following controls to be performed via external trigger signals.

Trigger Selector	Description
Frame Start	Start exposure in response to the external trigger signal input. Select this to perform exposure control using external triggers.
Acquisition Start	Start image acquisition in response to the external trigger signal input.
Acquisition End	Stop image acquisition in response to the external trigger signal input.
Acquisition Transfer Start	Output acquired images at a specified timing in response to an external trigger signal input. (Up to 7 frames for 8-bit, and up to 3 frames for 10-/12-bit.)

- ❖ The settings for exposure control and triggers are related to each other. Be sure to configure the settings described in “Configuring Exposure and External Trigger Settings” (page 17).

### Shortest Repetition Period for Triggers

The reciprocal of the maximum frame rate is the time required to output one frame. The shortest repetition periods for triggers cannot be lower than that value.

#### ■ When [Exposure Mode] is [Timed]

**Example: When [Trigger Source] is set to [Line 5 - Optical In 1] and [OptIn Filter Selector] is set to [10 μs]**

Scanning range	Shortest period of trigger	
	8 bit (at 38 μs)	10 bit (at 73 μs)
Full	20.514 ms	30.782 ms
ROI 2/3 (Height = 810)	13.676 ms	20.683 ms
ROI 1/2 (Height = 608)	10.275 ms	15.786 ms
ROI 1/4 (Height = 304)	5.157 ms	8.415 ms
ROI 1/8 (Height = 152)	2.599 ms	4.731 ms
Binning Vertical 2*	20.514 ms	30.782 ms

The values in parentheses indicate exposure time.

\* GO-2400M-PGE only

Exposure and scanning cannot overlap on the GO-2400-PGE. The above table indicates the shortest trigger periods for the shortest exposure times. By adding the value of the exposure time you are using to the values in the table, you can determine the shortest trigger periods under your own usage environment.

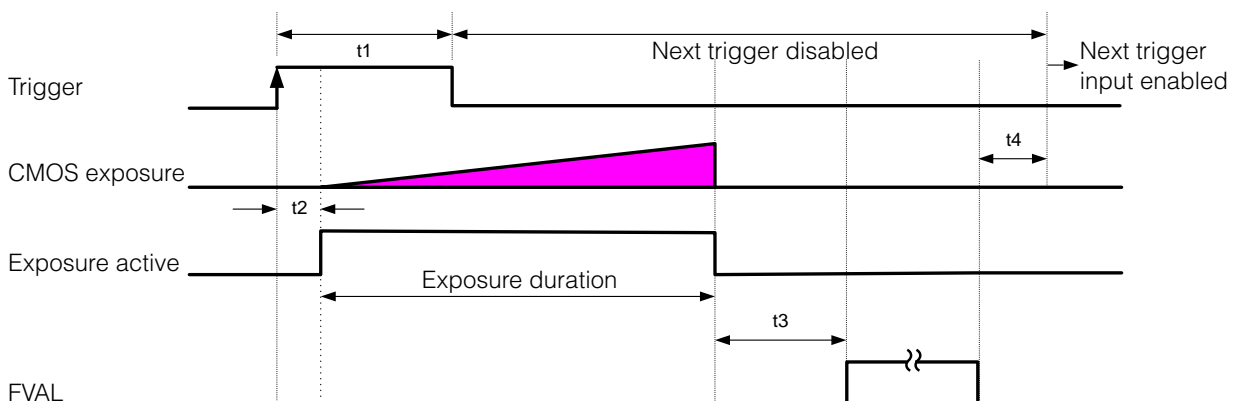

	t1	t2	t3	t4
8-bit	10 μs (minimum)	44.6 μs	428.4 μs	4.87 ms
10-bit packed		80.0 μs	827.8 μs	336 μs
10-bit				10.6 ms

## ■ When [Exposure Mode] is [Trigger Width]

**Example: When [Trigger Source] is set to [Line 5 - Optical In 1] and [OptIn Filter Selector] is set to [10  $\mu$ s]**

Scanning range	Shortest period of trigger	
	8 bit (at 37.4 $\mu$ s)	10 bit (at 72.7 $\mu$ s)
Full	20.514 ms	30.782 ms
ROI 2/3 (Height = 810)	13.676 ms	20.683 ms
ROI 1/2 (Height = 608)	10.275 ms	15.786 ms
ROI 1/4 (Height = 304)	5.157 ms	8.415 ms
ROI 1/8 (Height = 152)	2.599 ms	4.731 ms
Binning Vertical 2*	20.514 ms	30.782 ms

The values in parentheses indicate exposure time.

\* GO-2400M-PGE only

Exposure and scanning cannot overlap on the GO-2400-PGE. The above table indicates the shortest trigger periods for the shortest exposure times. By adding the value of the exposure time you are using to the values in the table, you can determine the shortest trigger periods under your own environment.

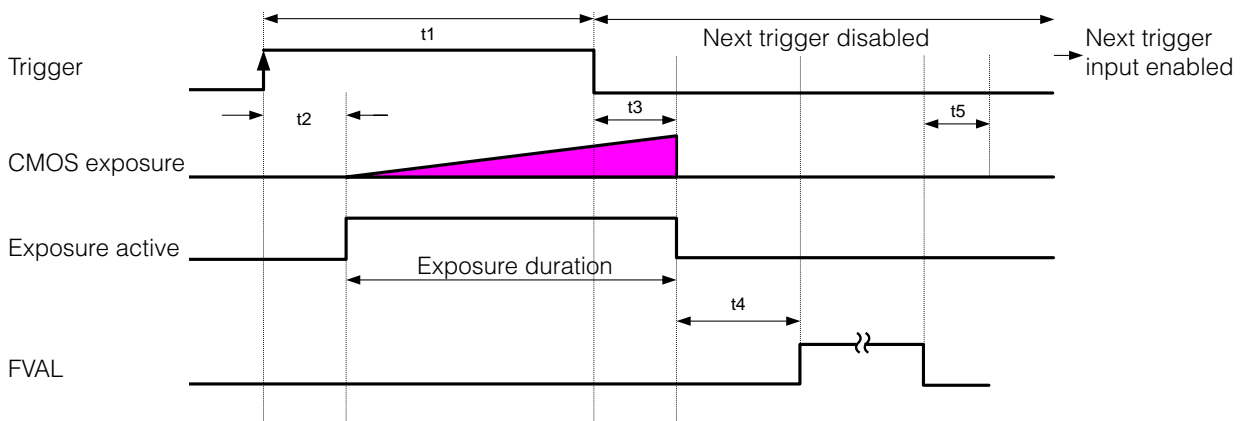

	t1	t2	t3	t4	t5
8-bit	37.4 $\mu$ s	44.6 $\mu$ s	24.5 $\mu$ s	428.4 $\mu$ s	4.87 ms
10-bit packed	72.7 $\mu$ s	80.0 $\mu$ s	80.0 $\mu$ s	827.8 $\mu$ s	336 $\mu$ s
10-bit					10.6 ms

## ■ During normal continuous operation (both [Exposure Mode] and [Trigger Mode] disabled)

When using an application that does not require external triggers, the shortest repetition period will be as follows.

Scanning range	Shortest period of trigger	
	8-bit	10-bit
Full	20.474 ms	30.708 ms
ROI 2/3 (Height = 810)	13.639 ms	20.610 ms
ROI 1/2 (Height = 608)	10.300 ms	15.713 ms
ROI 1/4 (Height = 304)	5.120 ms	8.343 ms
ROI 1/8 (Height = 152)	2.561 ms	4.658 ms
Binning Vertical 2*	20.474 ms	30.708 ms

The values in parentheses indicate exposure time.

\* GO-2400M-PGE only

# Event Control

“Event control” is a function that uses GVCP (GigE Vision Control Protocol) to output points of change in the camera’s internal signal as event occurrence information or “event messages.” When this information is output, the camera’s internal timestamp counter value is added.

## ■ Event message occurrence diagram

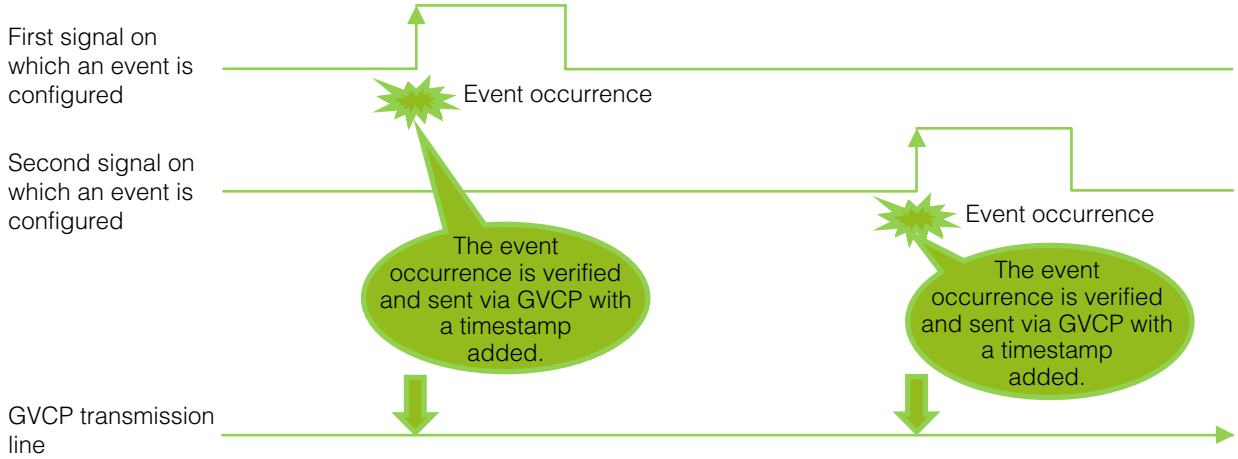

## ■ Internal camera blocks

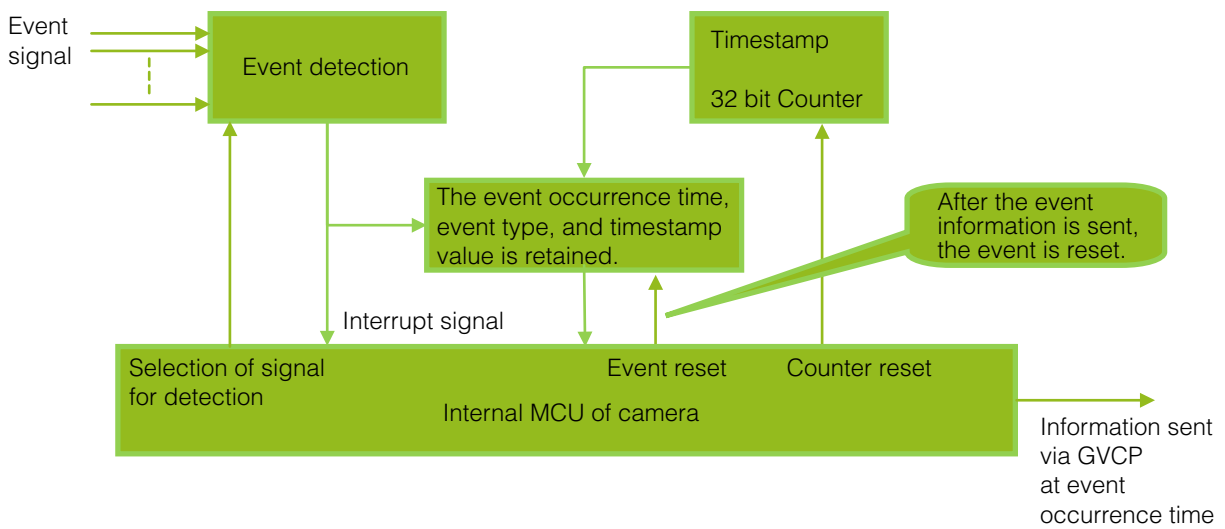

## ■ To use the event control function

Configure the settings as follows.

Item	Setting value / selectable range	Description
Event Selector	Acquisition Trigger, Frame Start, Frame End, FVAL Start, FVAL End, Exposure Start, Exposure End, Line2(Opt Out1) RisingEdge, Line3(Opt Out2) RisingEdge, Line5(Opt In1) RisingEdge, Line2(Opt Out1) FallingEdge, Line3(Opt Out2) FallingEdge, Line5(Opt In1) FallingEdge	Select the event for which to send notifications.
Event Notification	On	Output event messages.

### Note

[Event Notification] is set to [Off] and event messages will not be output under factory default settings.

## Gain Control

[Analog All] can be used for gain control for both the monochrome and color camera. [Analog All] (master gain) uses the sensor's internal gain function and consists of analog gain + digital gain. Analog gain is used for lower gain, and analog gain + digital gain is used when the gain becomes high. R and B can be configured individually as digital gain on the GO-2400C-PGE.

❖ For details on how to configure the settings, see "Adjusting the Gain" (page 21).

The relationship between the gain setting value, gain amplification, and dB value is as follows. For example, a gain amplification of x5.62 will be 15 dB.

### Monochrome

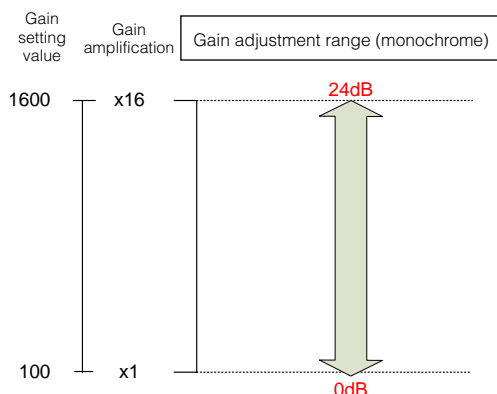

## Bayer color

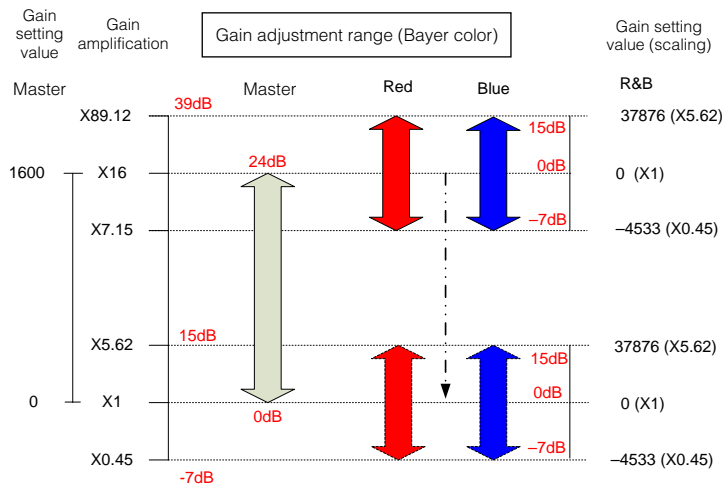

## LUT (Lookup Table)

The LUT function is used to generate a non-linear mapping between signal values captured on the sensor and those that are output from the camera. You can specify the output curve using 256 setting points (indexes).

### ■ To use the LUT function

Configure the settings as follows.

Item	Setting value / selectable range	Description
JAI LUT Mode	LUT	Use LUT.
LUT Selector*	R, G, B	Select the LUT channel to control.
LUT Index	GO-2400M-PGE: 0 to 255 GO-2400C-PGE: 0 to 255	Select the LUT index to configure. Indexes represent the possible pixel values captured on the sensor, from the lowest value (Index 0) to the highest (Index 255). For example, Index 0 represents a full black pixel and Index 255 represents a full white pixel.
LUT Value	0 to 4095	Set the LUT output value for the selected index.

\* GO-2400C-PGE only

### Note

For the GO-2400C-PGE, the same characteristic curve is configured for R, G, and B.

### ■ LUT values

LUT values range from 0 at the lowest to 4095 at the highest. Linear interpolation is used to calculate LUT values between the index points.



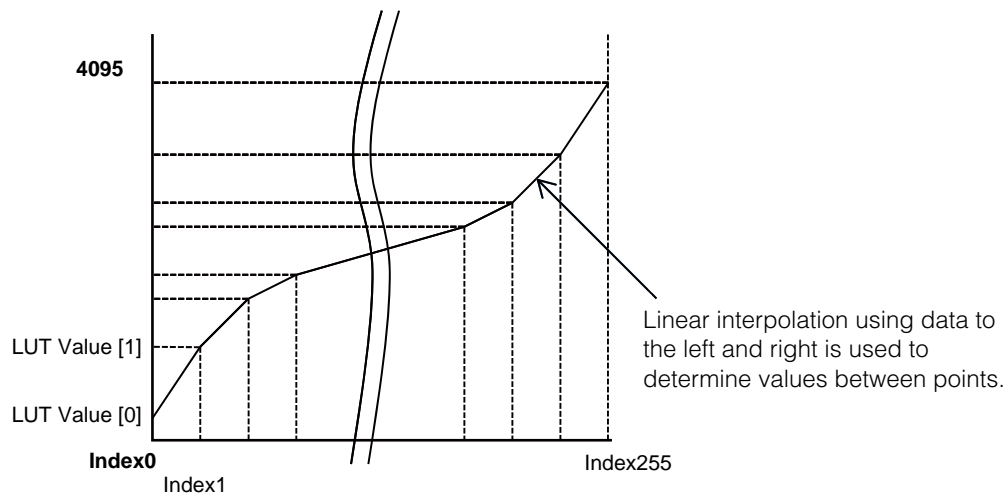

## Gamma Function

The gamma function corrects the output signals from the camera beforehand (reverse correction), taking into consideration the light-emitting properties of the monitor display.

As the light-emitting properties of the monitor are not linear, the entire image may be darker or the gradation in the dark areas may be less noticeable when camera outputs are displayed without processing.

The gamma function can be used to correct the camera signals with an opposite-direction curve and produce a display that is close to linear.

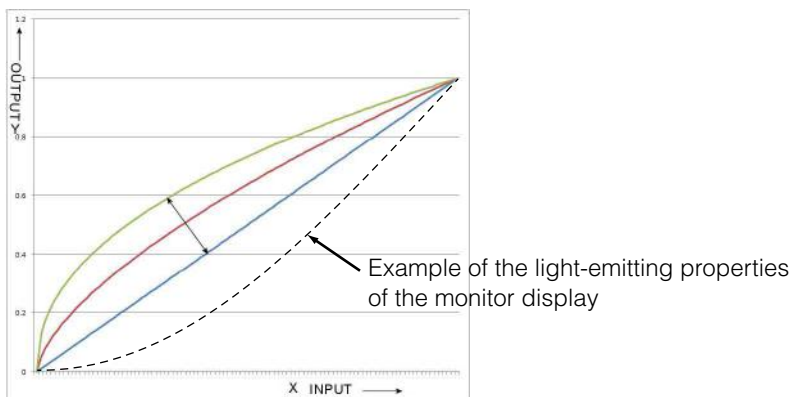

### ■ To use the gamma function

Configure the settings as follows.

Item	Setting value / selectable range	Description
Gamma	0.45, 0.60, 1.0 (Off)	Select the gamma correction value.
JAI LUT Mode	Gamma	Use gamma.

#### Note

You can use the LUT function to configure a curve with more detailed points. For details, see "LUT (Lookup Table)" (page 32).

## Line Status

The line status function allows you to verify the status of external input/output signals. You can verify the status of the following signals.

- Opt Out 1, Opt Out 2, Opt In 1
- Time Stamp Reset
- NAND Gate 0 In 1, NAND Gate 0 In 2, NAND Gate 1 In 1, NAND Gate 1 In 2

## Shading Correction

The shading correction is a function that corrects non-uniformity (i.e., shading) in the amount of light generated by the lens and lighting equipment. Using this function allows correction even if top, bottom, left, and right shading is not symmetrical in relation to the center of the screen (H, V).

The size of the correction block is 16 (H) × 10 (V) blocks and calculation errors in the correction data are minimized due to the small interpolation block. Each block is 128 × 128 pixels. The total size of the blocks is 2048 (H) × 1280 (V), but the actual number of effective pixels for the camera is 1936 (H) × 1216 (V). The ineffective peripheral areas will be deleted internally on the camera automatically.

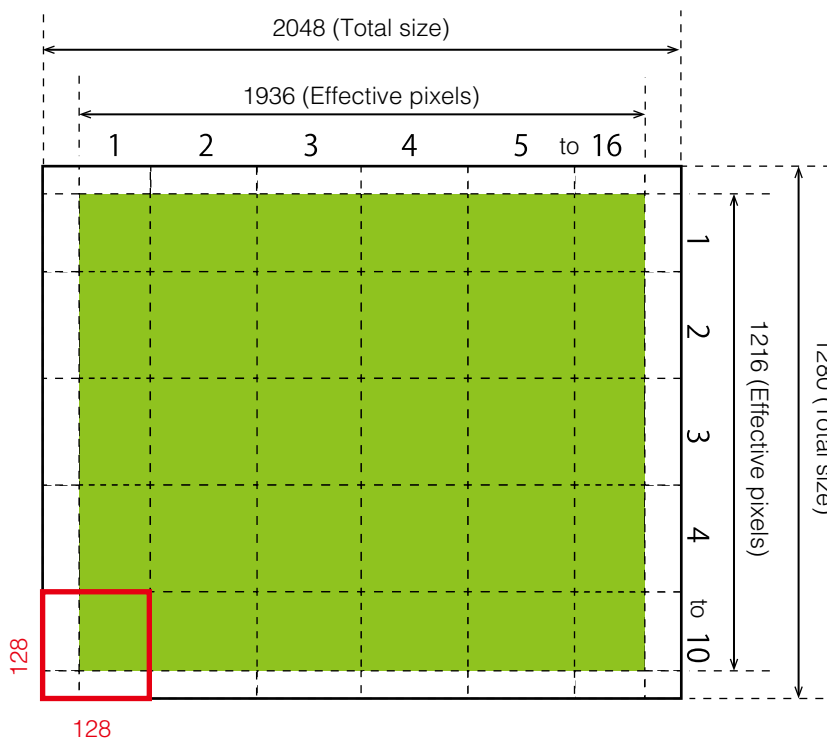

The following shading correction modes are available on the camera.

### ■ Flat Shading

Correction is performed using the area of the screen with the highest brightness level as the reference, and adjusting the brightness levels of the other areas to match this level.

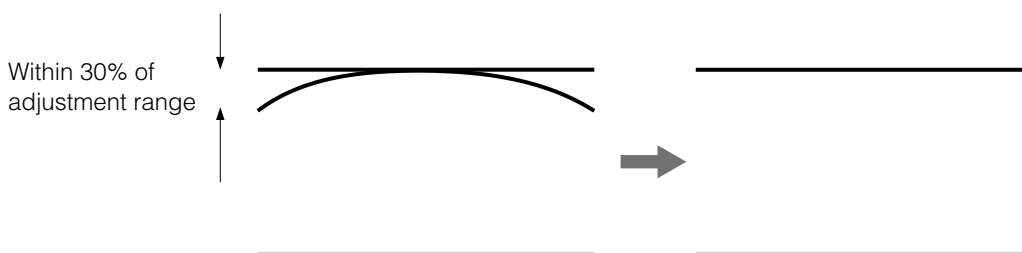

## ■ Color Shading (GO-2400C-PGE only)

R-channel and B-channel properties are adjusted to using the G-channel shading properties as a reference.

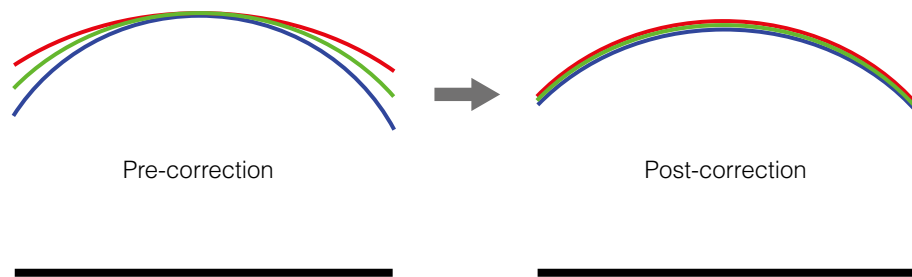

### Caution

Proper correction is not possible under the following conditions.

- If an area with a brightness level that is more than 30% less than the reference level exists within the screen
- If the brightness level is saturated in parts or all of the screen
- If the area in the screen with the highest brightness level is 300 LSB or less (during 10-bit video output)

## ■ To use the shading correction function

Configure the settings as follows.

Item	Setting value	Description
Shading Correction Mode	GO-2400M-PGE: Flat Shading (fixed) GO-2400C-PGE: Flat Shading, Color Shading	Select the shading correction mode.
Shading Mode	User 1, User 2, User 3	Select the user area to which to save the shading correction value.

Display a white chart under a uniform light, and execute [Perform Shading Calibration].

### Note

After shading correction is executed, the shading correction value is automatically saved to the user area selected in [Shading Mode].

## Binning Function

The binning function allows you to combine the signal values of clusters of adjacent pixels on the sensor to create improved virtual pixels. Using the function results in images with lower pixel resolution and higher sensitivity.

Common methods of binning include “horizontal binning” where two horizontally adjacent pixels are combined, and “vertical binning” where two vertically adjacent pixels are combined. By combining the horizontal and vertical methods to create a group of four pixels (2×2 binning), you can create images with x4 sensitivity.

## ROI (Regional Scanning Function)

The ROI (region of interest) function allows you to output images by specifying the areas to scan.

### ROI Settings

Specify the area to scan by specifying width, height, and horizontal/vertical offset values under [Image Format Control].

❖ For details on how to configure the settings, see “Configuring the Output Format” (page 16).

You can increase the frame rate by specifying a lower height, as the number of lines scanned decreases.

The minimum area is as follows.

	Width (pixels)	Height (pixels)
GO-2400M-PGE	Binning Off: 16 Binning 2 On: 8  ❖ The minimum value for Monochrome varies depending on the [Binning] setting.	1
GO-2400C-PGE	16	2

#### Example 1: Without binning

[Binning Horizontal]  $\uparrow$ : 1

[Binning Vertical]  $\uparrow$ : 1

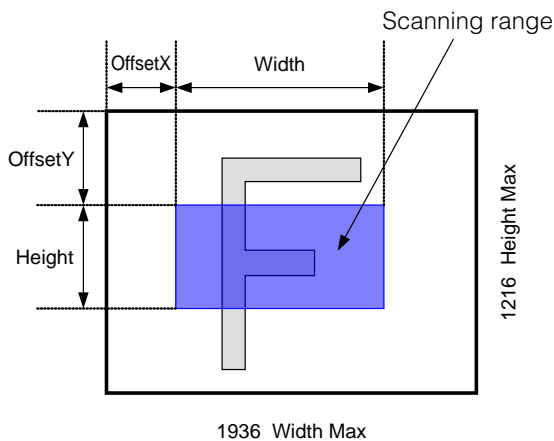

#### Example 2: With binning

[Binning Horizontal]  $\uparrow$ : 2

[Binning Vertical]  $\uparrow$ : 2

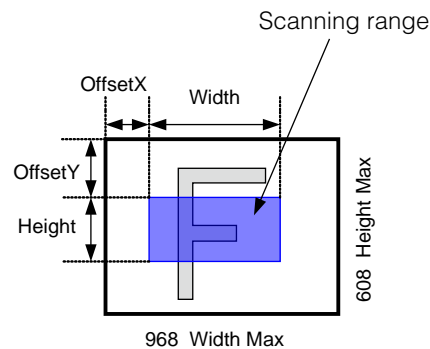

\* GO-2400M-PGE only

❖ For details on the frame rates for common ROI sizes, see “Frame Rate Reference” (page 60).

## Video Send Mode

Switch the video send mode to configure and operate Multi ROI, Sequence Trigger, and other JAI Custom Control functions.

### Video Send Mode

#### ■ To switch the video send mode

Select the video send mode in [Video Send Mode Selector].

[Video Send Mode Selector] option	Description
Normal Mode	Normal camera operation.
Multi Mode (Multi ROI)	Multi ROI mode that allows you to configure ROI settings for up to 5 images.
Trigger Sequence Mode	Sequence Trigger mode that executes presets in a predefined order based on [Sequence Roi Frame Count] and [Sequence Roi Next Index]. Starts at Index #1.
Command Sequence Mode	Sequence Trigger mode that executes the preset listed in [Command Sequence Index] each time a trigger is received. Can jump to new preset by sending a new index value to [Command Sequence Index].

#### ■ Multi ROI Mode

In the multi ROI mode, you can specify up to five scanning areas (Index 1 to 5) for a single-frame image. On the GO-2400-PGE, the areas can overlap, and a separate frame will be output for each area.

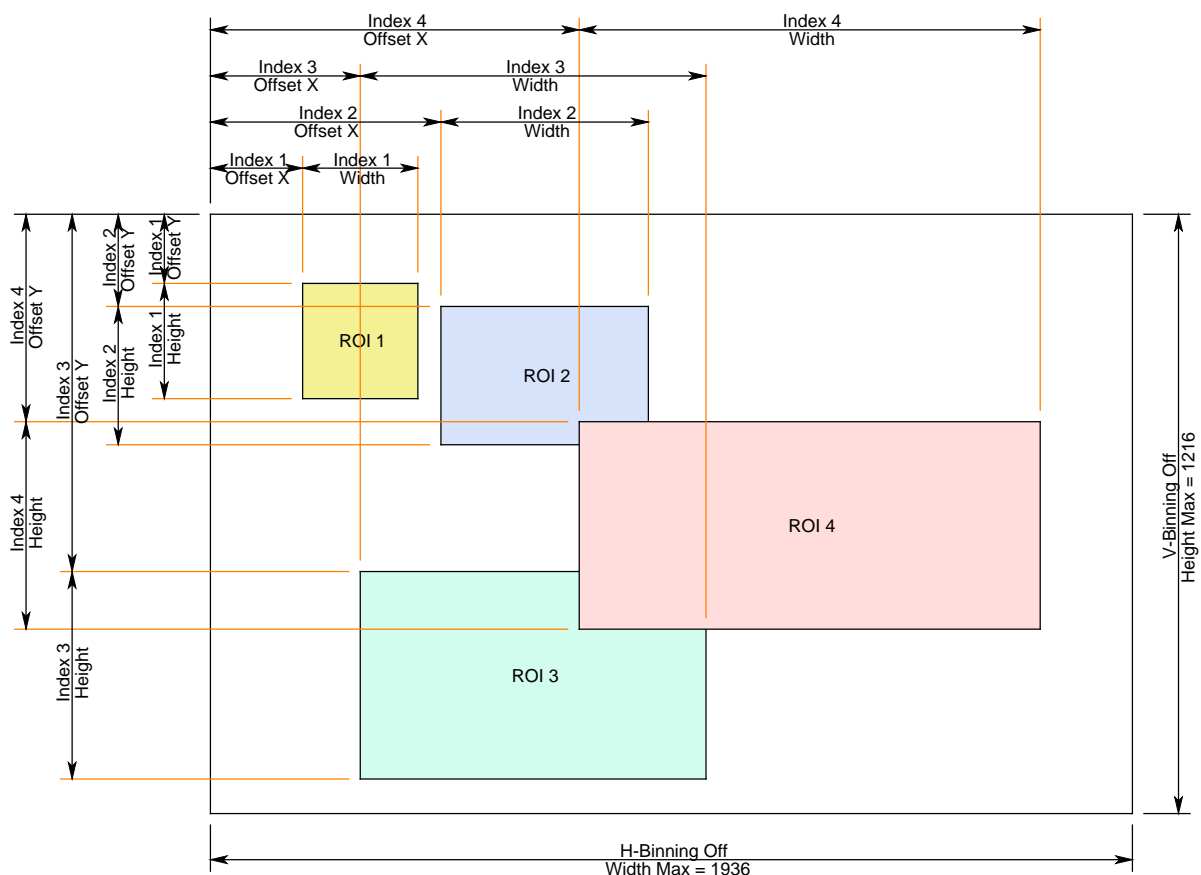

Specify the areas by specifying width, height, and horizontal/vertical offset values for each index under [JAI Custom Control MultiROI].

## ■ Sensor Multi ROI Function

Sensor Multi ROI is an ROI function that is configured and functions inside the sensor.

You can configure up to 16 scanning regions (4 horizontal and 4 vertical).

By skipping areas that are not specified as regions of interest when scanning a frame, the sensor's ROI function outputs the specified regions in a compressed state. You can increase the frame rate due to the reduced scanning time for the compressed areas. However, you cannot make the line frequency faster by compressing in the horizontal direction.

The areas selected with the ROI function will be compressed.

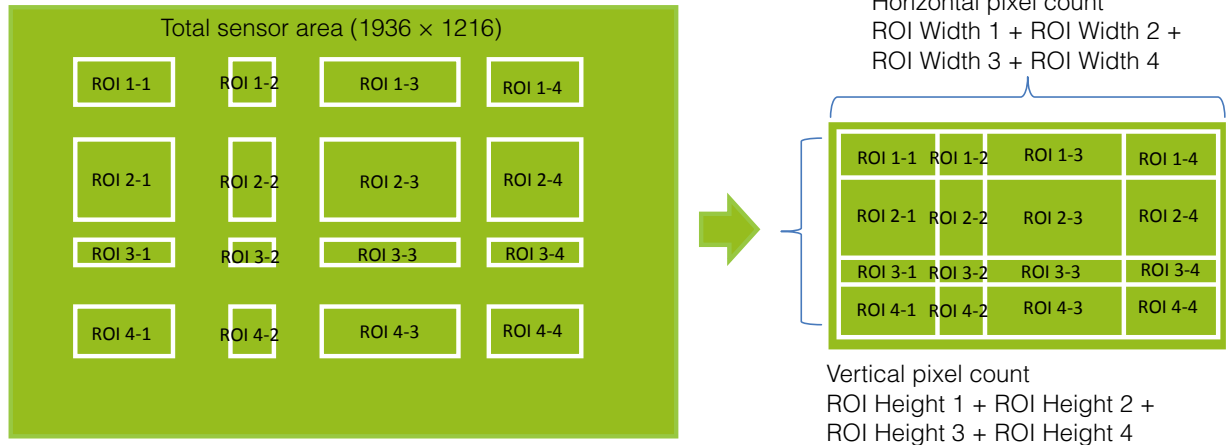

### Restrictions

- The specified areas cannot overlap.
- The frame rate can be increased in relation to size of the area specified in the vertical direction, but not in relation to the horizontal direction.
- In the horizontal direction, the configuration for the second and subsequent row will be identical. In the vertical direction, the configuration for the second and subsequent column will be identical.

### Configuration

Configure each area so that they do not overlap.

Both the horizontal and vertical settings must be configured as even values.

#### Horizontal ROI conditions

$\text{ROI Offset H1} + \text{ROI Width 1} < \text{ROI Offset H2}$

$\text{ROI Offset H2} + \text{ROI Width 2} < \text{ROI Offset H3}$

$\text{ROI Offset H3} + \text{ROI Width 3} < \text{ROI Offset H4}$

$\text{ROI Offset H4} + \text{ROI Width 4} < 1936$

#### Vertical ROI conditions

$\text{ROI Offset V1} + \text{ROI Height 1} < \text{ROI Offset V2}$

$\text{ROI Offset V2} + \text{ROI Height 2} < \text{ROI Offset V3}$

$\text{ROI Offset V3} + \text{ROI Height 3} < \text{ROI Offset V4}$

$\text{ROI Offset V4} + \text{ROI Height 4} < 1216$

Configure the four index settings (Index 1 to 4). The [OffsetH], [Width], [OffsetV], [Height], [Horizontal Enable], and [Vertical Enable] settings can be configured for each index.

When you configure the [OffsetH], [Width], [OffsetV], and [Height] settings for an index and set [Horizontal Enable] or [Vertical Enable] to [True] for that index, the corresponding area is configured. When [False] is specified, the settings within the index are disabled.

OffsetH, Width: 16 pixels/step

OffsetV, Height: 2 lines/step

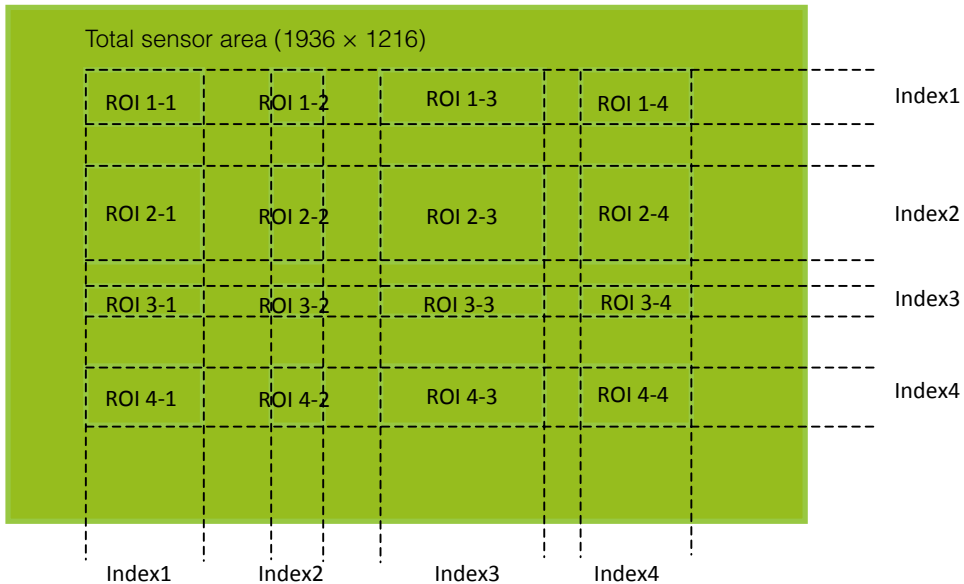

**Reference: Areas corresponding to the [Horizontal Enable] and [Vertical Enable] settings of each setting**

Index 1		Index 2		Index 3		Index 4		Number of Enabled ROI	Enabled area
Hori	Vert	Hori	Vert	Hori	Vert	Hori	Vert		
True	True	False	False	False	False	False	False	1	ROI 1-1
True	True	True	True	False	False	False	False	4	ROI 1-1, ROI 1-2, ROI 2-1, ROI 2-2
True	True	True	False	False	False	False	False	2	ROI 1-1, ROI 1-2
True	True	True	True	True	True	False	False	9	ROI 1-1, ROI 1-2, ROI 1-3 ROI 2-1, ROI 2-2, ROI 2-3 ROI 3-1, ROI 3-2, ROI 3-3
True	True	True	True	True	True	True	False	12	ROI 1-1, ROI 1-2, ROI 1-3, ROI 1-4 ROI 2-1, ROI 2-2, ROI 2-3, ROI 2-4 ROI 3-1, ROI 3-2, ROI 3-3, ROI 3-4
True	True	True	True	True	True	True	True	16	ROI 1-1, ROI 1-2, ROI 1-3, ROI 1-4 ROI 2-1, ROI 2-2, ROI 2-3, ROI 2-4 ROI 3-1, ROI 3-2, ROI 3-3, ROI 3-4 ROI 4-1, ROI 4-2, ROI 4-3, ROI 4-4

### Frame rate calculation formula

$FR + \text{line frequency} \div (\text{ROI Height 1} + \text{ROI Height 2} + \text{ROI Height 3} + \text{ROI Height 4} + \text{vertical invalid line})$

There are two types of line frequencies.

SensorReadout 10 bit, camera output 8 bit: 12.4445 KHz

SensorReadout 12 bit, camera output 10 bit: 24.2425 KHz

Vertical invalid line: 40 (fixed)

## Differences when Multi ROI Overlap is on or off

Operations will be as follows in On Mode and Off Mode of Multi ROI Overlap.

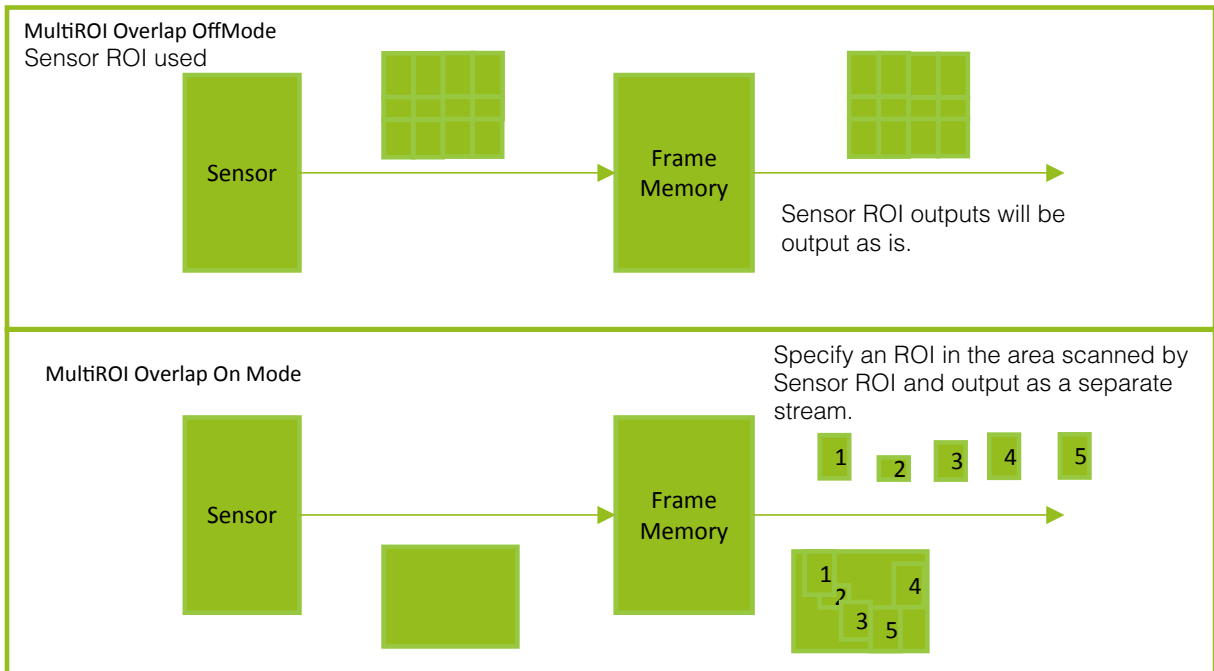

### ■ Sequence Trigger function

The Sequence Trigger function lets you define up to 128 preset combinations of exposure time, gain, ROI, and other settings which can be stepped through each time a trigger is received. This is particularly useful for quickly capturing multiple exposures of objects under inspection to adjust for areas or components with significantly different levels of reflectance. The order of execution and the repetition of particular presets are based on user-defined parameters stored in the sequence, as well as the sequence mode selected in the [Video Send Mode Selector].

Two operation modes (Trigger Sequence and Command Sequence) are available for the Sequence Trigger function.

### Trigger Sequence mode

With this mode, the Sequence Trigger "pattern" is predetermined by the user. The user defines up to 128 different "indexes." Each index represents a combination of the following parameters:

- ROI (width, height, offset X, and offset Y)
- Exposure Time
- Gain Level (R/B Gain can also be configured on the color model)
- Black Level
- Binning Mode (monochrome only)
- LUT Enable (whether or not to enable the use of LUT for this index)
- Frame Count (the number of times to repeat this index before moving to the next)
- Next Index to execute in the predetermined pattern

In addition to these individual index parameters, two other parameters are applied to the entire sequence:

[Sequence LUT Mode] defines whether Gamma or LUT is to be applied to the sequence. If Gamma is selected, the Gamma setting defined in the camera's Analog Control section will be applied to all exposures in the sequence. If LUT is selected, the LUT characteristics defined in Analog Control will be applied to any index where [Sequence LUT enable] has been set to ON.

[Reset Sequence Index] causes the index selector to be reset to Index 1. Thus, the sequence pattern will start over at the next trigger.



In Trigger Sequence mode, patterns always begin with Index1. Subsequent triggers follow the user-defined values in [Sequence Index Frame Count] and [Sequence ROI Next Index].

Assigning a Next Index value of “1” to an index creates a loop back to the start of the sequence pattern. As there is no defined “end” to a sequence, the parameter called [Sequence Repetition] has no effect.

### Trigger Sequence example

User-defined Indexes (up to 128)

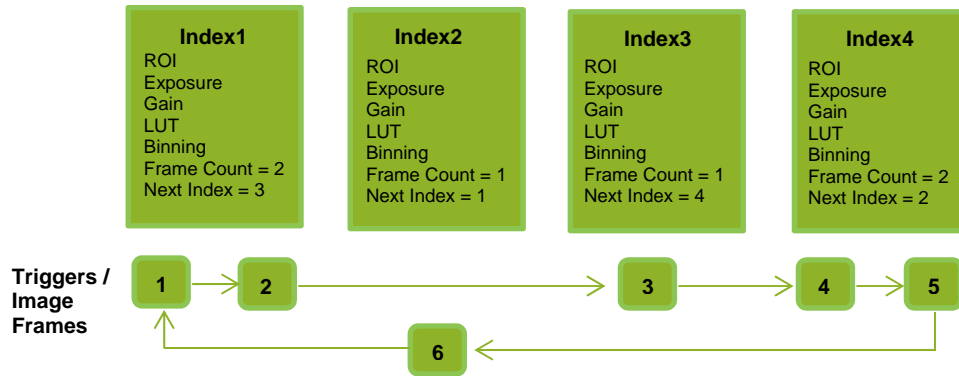

### Index structure for Trigger Sequence

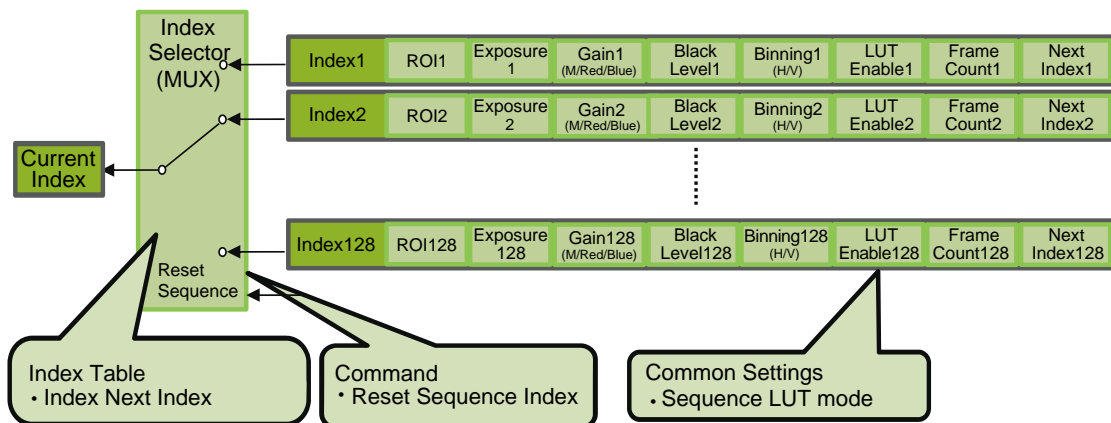

### Command Sequence mode

This mode allows the user to vary the “pattern” of the sequence in response to external factors. Changes in the sequence can be initiated manually or in a programmatic fashion as the result of data from sensors/controllers or from the analysis of previous images.

In this mode, the user can define up to 128 different “indexes” each incorporating a combination of:

- ROI (width, height, offset X, and offset Y)
- Exposure Time
- Gain Level (R/B Gain can also be configured on the color model)
- Black Level
- Binning Mode (monochrome only)
- LUT Enable (whether or not to enable the use of LUT for this index)

The user must also enter a value from 1 to 128 in [Command Sequence Index]. This indicates which index to execute each time a trigger is received. The same index will continue to be executed for all subsequent triggers as long as the value of [Command Sequence Index] remains unchanged.

Changing the value of [Command Sequence Index] to one of the other predefined indexes causes that index to be executed in response to subsequent triggers. This mode of operation enables users to develop applications that continually send new values to [Command Sequence Index] in response to

external factors such as changing light conditions, different types or sizes of objects being inspected, or other factors. This allows applications to change ROI, exposure, gain, etc., without being restricted to a predefined pattern.

As with Trigger Sequence, [Sequence LUT Mode] defines whether Gamma or LUT is to be applied to the sequence. If Gamma is selected, the Gamma setting defined in the camera's Analog Control section will be applied to all exposures in the sequence. If LUT is selected, the LUT characteristics defined in Analog Control will be applied to any index where [Sequence LUT enable] has been set to ON.

[Sequence Index Frame Count], [Sequence ROI Next Index], and [Reset Sequence Index] are not used in Command Sequence mode and entered values are ignored.

**Command Sequence Example**

User-defined Indexes (up to 128)

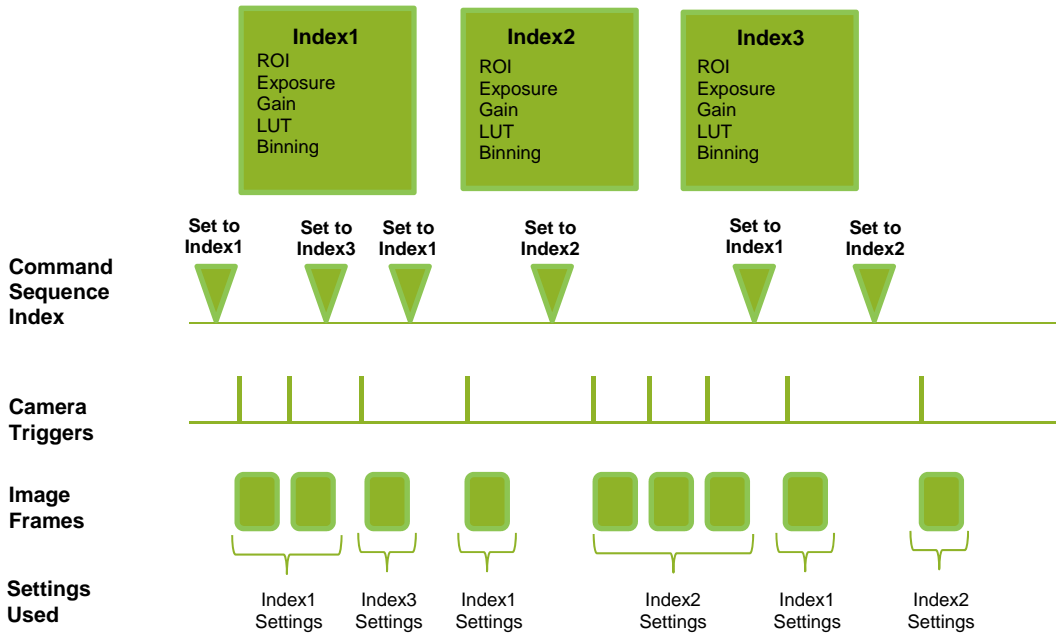

**Index structure for Command Sequence**

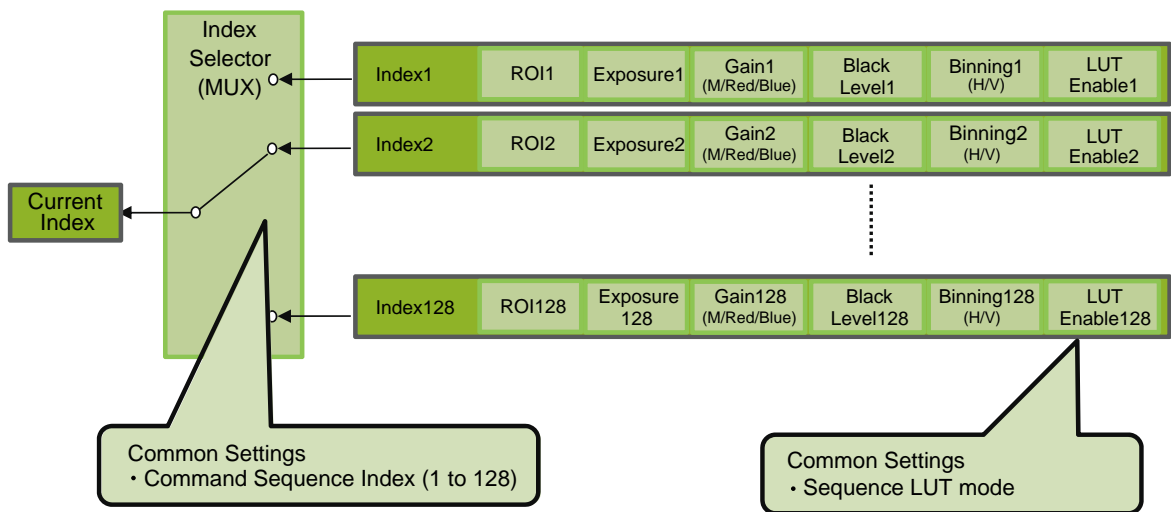

## Delayed Readout [Acquisition Transfer Start]

Delayed readout enables images captured by a Frame Start trigger command to be stored inside the camera and read out on demand at a later time using Acquisition Transfer Start trigger. This can be especially useful when multiple cameras need to be triggered at the same time, but simultaneous readout of all images would overwhelm the available network bandwidth. The delayed readout buffer can hold up to 7 frames in 8-bit mode or 3 frames in 10-bit or 12-bit modes.

❖ For details, see “Trigger Control” (page 28).

## ALC (Automatic Level Control) Function

The ALC (automatic level control) function combines the automatic gain control (AGC/Auto Gain Control) and automatic exposure control (ASC/Auto Shutter Control) functions, and is capable of handling various changes in brightness.

The function operates as follows in response to changes in brightness.

Change from bright to dark: ASC → AGC

Change from dark to bright: AGC → ASC

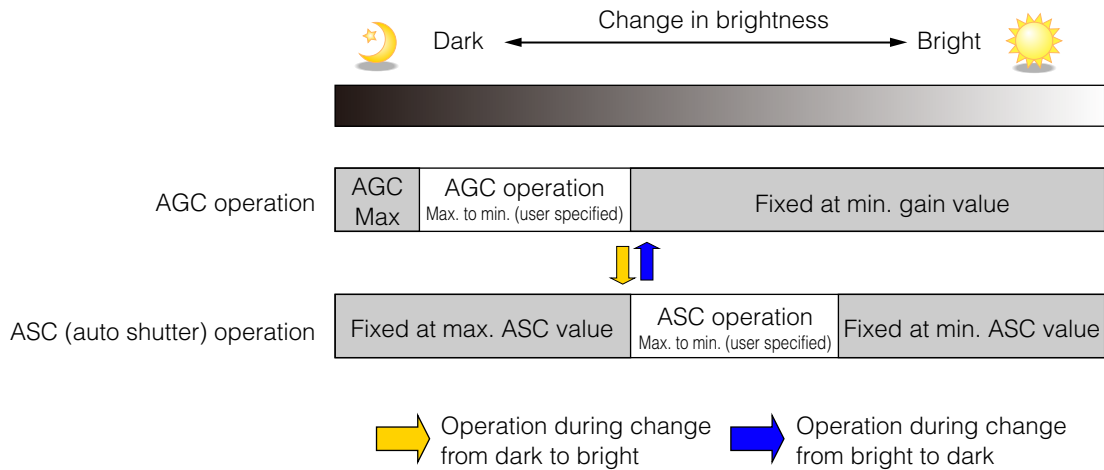

### ■ To use the ALC function

Set [Gain Auto] or [Exposure Auto] or both to [Continuous] mode. Configure the minimum value, maximum value, etc. for AGC and ASC under [JAI Custom Control ALC].

The target video levels for AGC and ASC are configured in [ALC Reference]. For example, when [ALC Reference] is set to 100%, video levels will be maintained at 100% for AGC and ASC.

### ■ Automatic gain level control

Set [Gain] to [Continuous].

## Detailed Settings for Gain Auto (Automatic Gain Level Control)

When [Gain Auto] is set to [Continuous], you can configure the conditions for automatic adjustment in detail.

Item	Description
ALC Reference	Specify the target level for automatic gain control. (This setting is also used for automatic exposure control.)
ALC Area Enable All	Select whether to specify all areas as auto gain metering areas or whether to specify the areas individually. [0]: Specify areas as auto gain metering areas (16 areas) individually. [1]: Specify all areas as auto gain metering areas.
ALC Area Selector	Individually select any of 16 areas for automatic gain metering. (This setting is also used for automatic exposure control.)
ALC Area Enable	Select [True] to enable the metering area selected in [ALC Area Selector], or select [False] to disable it.
AGC Max.	Specify the maximum value for the automatic gain control range.
AGC Min.	Specify the minimum value for the automatic gain control range.
AGC/ASC Control Speed	Specify the reaction speed for automatic gain control. (This setting is also used for automatic exposure control.)

### Auto gain metering areas (16 areas)

High Left	High Mid-left	High Mid-right	High Right
Mid-High Left	Mid-High Mid-left	Mid-High Mid-right	Mid-High Right
Mid-Low Left	Mid-Low Mid-left	Mid-Low Mid-right	Mid-Low Right
Low Left	Low Mid-left	Low Mid-right	Low Right

## Counter and Timer Control Function (counter support only)

The counter function counts up change points in the camera's internal signals using the camera's internal counter, and reads that information from the host side. This function is useful for verifying error conditions via the count value using internal camera operations.

Counting is performed at frame trigger, frame start, exposure start, and exposure transfer end, and by comparing these values, you can determine the internal camera state at which missed triggers will occur.

### Counter occurrence diagram

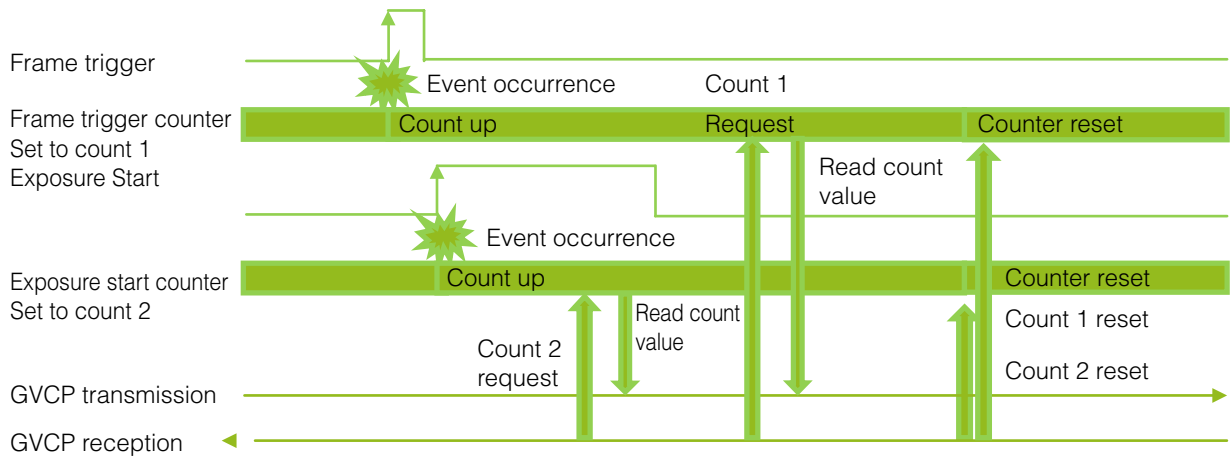

#### Note

To reset the counter itself, execute [Counter Reset] or enter "1" in [Counter Reset].

### Internal camera blocks

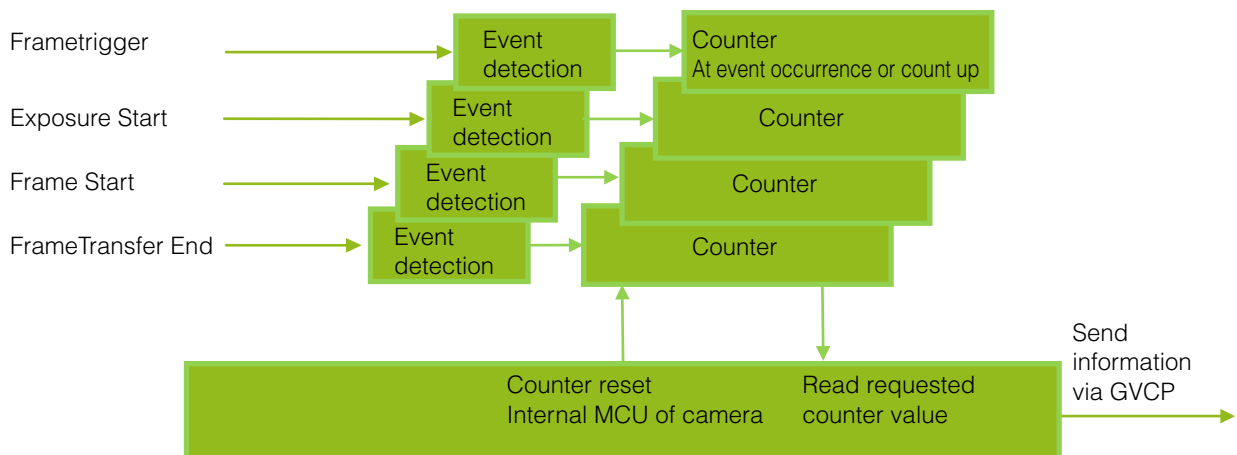

## ■ To use the counter function

Configure the settings as follows.

Three counters can be configured (Counter 0 to 2).

Item	Setting value / selectable range	Description
Counter 0 to 2	Counter 0 to 2	Select the counter.
Counter 0 to 2 Event Source	Off, Frame Trigger, Frame Start, Exposure Start, Exposure Transfer End	Select the counter event signal for which to read the count value.
Counter 0 to 2 Event Activation	Rising Edge (fixed) or Falling Edge	Specify the timing at which to count.

### Note

The four counter event signals are always counted up internally on the camera.

## Video Process Bypass Mode

The video process bypass mode is a function that bypasses internal video processing on the camera. When bypass is enabled, the sensor output and camera output data can be set to the same bit width. Operation using 12-bit outputs must be performed in bypass mode.

Video process bypass mode	On	Off
Camera operation	All video processes except Gain all (excluding R/B Gain) and Blemish Compensation are disabled.	All video processes are enabled.
Camera output	8-/10-/12-bit	8-/10-bit

## ■ Differences in camera operation

### When video process bypass mode is disabled

All video processes are enabled.

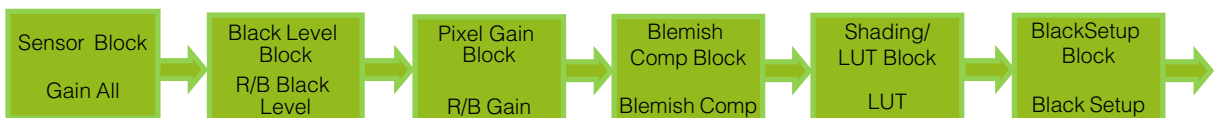

### When video process bypass mode is enabled

All video processes except Gain all (excluding R/B Gain) and Blemish Compensation are disabled.

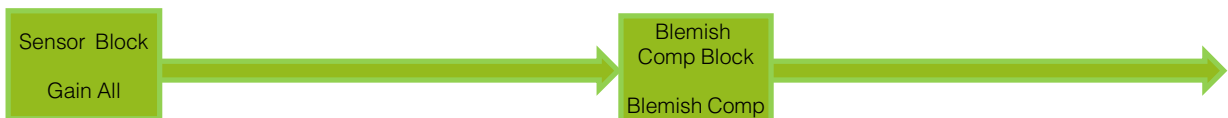

## ■ To enable video process bypass mode

Item	Setting value / selectable range	Description
Video Process Bypass Mode	On	Enable video process bypass mode.

# Settings List

## Feature Properties

: Settings that can only be configured when image acquisition on the camera is stopped.

Item	Setting range	Default value	Description
<b>a) Device Control</b>			Display/configure information related to the device.
Device Vendor Name	—	—	Display the manufacturer name.
Device Model Name	—	—	Display the model name.
Device Manufacturer Info	—	—	Display the device information.
Device Version	—	—	Display the hardware version.
Device Firmware Version	—	—	Display the firmware version.
Device ID	—	—	Display the device ID.
Device User ID	Any	—	Set the user ID for the camera.
Device Temperature in degrees Celsius	—	—	Display the internal temperature (°C) of the camera.
Device Reset	—	—	Reset the device.
<b>b) Image Format Control</b>			Configure image format settings.
Width Max	—	1936	Display the maximum image width.
Height Max	—	1216	Display the maximum image height.
Width	Binning Off: 16 to 1936 Binning 2 On: 8 to 968 ❖ The minimum value for Monochrome varies depending on the [Binning] setting.	1936	Set the image width.
Height	GO-2400M-PGE: Binning Off: 1 to 1216 Binning 2 On: 1 to 608 GO-2400C-PGE: 2 to 1216 ❖ The minimum value for Monochrome varies depending on the [Binning] setting.	1216	Set the image height.
Offset X	—	0	Set the horizontal position.
Offset Y	—	0	Set the vertical position.
Binning Horizontal (GO-2400M-PGE only)	1, 2	1	Set the number of pixels in the horizontal direction for which to perform binning.
Binning Vertical (GO-2400M-PGE only)	1, 2	1	Set the number of pixels in the vertical direction for which to perform binning.
Pixel Format	GO-2400M-PGE: 8 Bit Monochrome, 10 Bit Monochrome, 10 Bit Monochrome Packed, 12 Bit Monochrome, 12 Bit Monochrome Packed GO-2400C-PGE: 8 Bit Bayer GR, 10 Bit Bayer GR (Unpacked), 10 Bit Bayer GR Packed, 12 Bit Bayer GR (Unpacked), 12 Bit Bayer GR Packed	GO-2400M-PGE: 8 Bit Monochrome GO-2400C-PGE: 8 Bit Bayer GR	Set the pixel format.
Test Image Selector	Off, Grey Horizontal Ramp, Grey Vertical Ramp, Grey Horizontal Ramp Moving	Off	Select the test image.

Item	Setting range	Default value	Description
<b>c) Acquisition Control</b>			
Acquisition Mode	Single Frame, Multi Frame, Continuous	Continuous	Select the image acquisition mode.
Acquisition Start	—	—	Start image acquisition.
Acquisition Stop	—	—	Stop image acquisition.
Acquisition Frame Count	1 to 255	153	In [Multi Frame] mode, set the number of frames to acquire.
Acquisition Frame Rate*	0.125 to 48.8496	48.8496	Set the frame rate as a frequency. (unit: Hz)
* Max. frequency/min. frame period depends on ROI, pixel format, and binning mode selected.			
Acquisition Frame Rate Raw*	20471 to 8000000	20471	Set the frame rate as a time. (unit: $\mu$ s)
* Max. frequency/min. frame period depends on ROI, pixel format, and binning mode selected.			
Trigger Selector	Acquisition Start, Acquisition End, Frame Start, Acquisition Transfer Start	Frame Start	Select the trigger operation.
Trigger Mode	Off, On	Off	Select the trigger mode.
Trigger Software	—	—	Execute a software trigger.
Trigger Source	Low, High, Software, Pulse Generator 0, User Output 0, User Output 1, Action 1, Action 2, Line 5 - Optical In 1, NAND0 Out, NAND1 Out	Line 5 - Optical In 1	Select the trigger signal source.
Trigger Activation	Rising Edge, Falling Edge, Level High, Level Low	Rising Edge (rising edge of input signal)	Select the polarity of the trigger signal (i.e., location of signal at which trigger is applied).
Trigger OverLap	Off (fixed)	Off	Select the trigger overlap operation.
Exposure Mode	Off, Timed, Trigger Width	Timed (control via exposure time)	Select the exposure mode.
Exposure Time	38 to 7999892 ( $\mu$ s)	20363 ( $\mu$ s)	Set the exposure time. The maximum value varies depending on the [Acquisition Frame Rate Raw] value.
Exposure Time Raw	38 to 7999892 ( $\mu$ s)	20363 ( $\mu$ s)	Set the raw exposure time.
Exposure Auto	Off, Continuous	Off	Set whether to enable auto exposure.
<b>d) Event Control</b>			
Event Selector	Acquisition Trigger, Frame Start, Frame End, FVAL Start, FVAL End, Exposure Start, Exposure End, Line2(Opt Out1) Rising Edge, Line3(Opt Out2) Rising Edge, Line5(Opt In1) Rising Edge, Line2(Opt Out1) Falling Edge, Line3(Opt Out2) Falling Edge, Line5(Opt In1) Falling Edge		Select the event for which to send notifications.
Event Notification	Off, On	Off	Select whether to output event messages.
<b>e) Analog Control</b>			
Gain Selector	GO-2400M-PGE: Digital All GO-2400C-PGE: Digital All, Digital Red, Digital Blue	Digital All (master gain)	Select the gain to configure.
Gain	Analog All: 1 to 16 Digital Red & Blue: 0.447 to 5.624 (color only)	Master gain: 1 R, B: 1	Set the gain value.



Item	Setting range	Default value	Description
Black Level Selector	GO-2400M-PGE: Digital All GO-2400C-PGE: Digital All, Digital Red, Digital Blue	Digital All (master black)	Select the black level to configure.
Black Level	Digital All: -133 to 255 Digital Red & Blue: -133 to 255 (color only)	0	Set the black level value.
Gain Auto	Off, Continuous	Off	Enable/disable gain auto adjustment.
Balance White Auto (GO-2400C-PGE only)	Off, On	Off	Enable/disable auto white balance.
Gamma	0.45, 0.60, 1.0	0.45	Set the gamma value.
JAI LUT Mode	Off, Gamma, LUT	Off	Select the JAI LUT mode.
<b>f) LUT Control</b>			Configure LUT settings.
LUT Selector (GO-2400C-PGE only)	R, G, B	R	Select the LUT channel to control.
LUT Index	GO-2400M-PGE: 0 to 255 GO-2400C-PGE: 0 to 255	0	Set the LUT index table number.
LUT Value	0 to 4095	0	Set the LUT value.
<b>g) Digital IO Control</b>			Configure settings for digital input/output.
Line Selector	Line2 - Opt Out 1, Line3 - Opt Out 2, Line5 - Opt In 1, Time Stamp Reset, NAND Gate 0 In 1, NAND Gate 0 In 2, NAND Gate 1 In 1, NAND Gate 1 In 2	Line2 - Opt Out 1	Select the input/output to configure.
Line Mode	—	Output	Display the input/output status (whether it is input or output).
Line Inverter	True, False	False	Enable/disable polarity inversion for the selected input signal or output signal.
Line Status	—	True	Display the status of the input signal or output signal (True: High, False: Low).
LineSource	Low, High, Acquisition Trigger Wait, Frame Trigger Wait, Frame Active, Exposure Active, FVAL, User Output 0, User Output 1, Line 5 - Opt In 1, Pulse Generator 0, Nand 0 Out, Nand 1 Out	Low	Select the line source signal for the item selected in [Line Selector].
Source Format	—	Opto Coupled	Display the current I/F type.
User Output Selector	User Output 0, User Output 1	User Output 0	Set the user output signal.
User Output Value	True, False	False	
<b>h) Pulse Generators</b>			Configure pulse generator settings.
Clock Pre-scaler	1 to 4096	1	Set the division value for the prescaler using the pixel clock as the base clock.
Pulse Generator Clock (MHz)	0.018127 to 74.25	74.25	Set the clock value (MHz) for the pulse generator.

Item	Setting range	Default value	Description
Pulse Generator Selector	Pulse Generator 0	Pulse Generator 0	Select the pulse generator.
Pulse Generator Length	1 to 1048575	1	Set the count-up value (clock value) for the pulse generator.
Pulse Generator Length (ms)	1.3E-05 to 14.1222	1.3468E-05	Set the count-up value for the pulse generator. (unit: ms)
Pulse Generator Frequency (Hz)	70.810386 to 74250000	7.425E+0.7	Set the frequency for the pulse generator.
Pulse Generator Start Point	0 to 1048574	0	Set the active output start count value for the pulse generator.
Pulse Generator Start Point (ms)	0 to 14.122209	0	Set the active output start count value for the pulse generator. (unit: ms)
Pulse Generator End Point	1 to 1048574	1	Set the active output stop count value for the pulse generator.
Pulse Generator End Point (ms)	1.3E-05 to 14.122222	1.3468E-05	Set the active output stop count value for the pulse generator. (unit: ms)
Pulse Generator pulse-width (ms)	—	1.3468E-05	Display the pulse width of the pulse generator. (unit: ms)
Pulse Generator Repeat Count	0 to 255	0	Set the repeat count for the pulse generator.
Pulse Generator Clear Activation	Off, High Level, Low Level, Rising Edge, Falling Edge	Off	Set the clear signal condition for the count clear input of the pulse generator.
Pulse Generator Clear Source	Low, High, Acquisition Trigger Wait, Frame Trigger Wait, Frame Active, Exposure Active, FVAL, User Output 0, User Output 1, Action 1, Action 2, Line 5 - Opt In 1, Nand 0 Out, Nand 1 Out	Low	Select the count clear input signal source.
Pulse Generator Clear Inverter	True, False	False	Select whether to invert the polarity of the count clear input signal.
Pulse Generator Clear Sync Mode	Async Mode, Sync Mode	Async Mode	Select the sync mode for the count clear input signal.
<b>i) Transport Layer Control</b>			Display information on transport layer control.
Payload Size	—	2354176	Display the payload size.
GigE Vision Major Version	—	1	Display the GigE version.
GigE Vision Minor Version	—	1	
Is Big Endian	—	True	Display the endianness.
Character Set	—	UTF8	Display the character set.

Item	Setting range	Default value	Description
Interface Selector	—	0	Set the interface.
Mac Address	—	XX-XX-XX-XX-XX-XX	Display the MAC address.
Supported LLA	—	True	Display whether LLA (link-local address) is supported.
Supported DHCP	—	True	Display whether DHCP is supported.
Supported Persistent IP	—	True	Display whether persistent IP is supported.
Current IP Configuration LLA	—	True	Display whether the current IP configuration is calibrated by LLA (link-local address).
Current IP Configuration DHCP	True, False	True	Select whether to set the IP configuration to DHCP.
Current IP Configuration Persistent IP	True, False	False	Select whether to set the IP configuration to persistent IP.
Current IP Address	—	XXX.XXX.XXX.XXX	Display the IP address.
Current Subnet Mask	—	255.255.0.0	Display the subnet.
Current Default Gateway	—	0.0.0.0	Display the default gateway.
Persistent IP Address	000.000.000.000 to 255.255.255.255	192.168.100.1	Set the persistent IP address.
Persistent Subnet Mask	000.000.000.000 to 255.255.255.255	255.255.255.0	Set the persistent subnet mask.
Persistent Default Gateway	000.000.000.000 to 255.255.255.255	0.0.0.0	Set the persistent default gateway.
GigE Vision Supported Option Selector	Link Local Address configuration, DHCP configuration, Persistent IP configuration, Stream Channel Source Socket, Message Channel Source Socket, Command Concatenation, Write Mem, Packet Resend, Event, Event Data, Pending Ack, Action, Extended Status Codes, Discovery Ack Delay, Discovery Ack Delay Writable, Test Data, Manifest Table, CCP Application Socket, Link Speed, Heartbeat Disable, Serial Number	Link Local Address configuration	Select the supported options for GigE Vision.
Supported Option	—	True	Enable/disable the supported options.
First URL	—	Local:XXXXXX	Display the first URL.
Second URL	—		Display the second URL.
Number Of Interfaces	—	1	Display the number of interfaces.
Message Channel Count	—	1	Display the message channel count.
Stream Channel Count	—	1	Display the stream channel count.
Supported Optional Commands EVENTDATA	—	False	Display whether EVENTDATA support is enabled or disabled.
Supported Optional Commands EVENT	—	True	Display whether EVENT support is enabled or disabled.
Supported Optional Commands PACKET RESEND	—	True	Display whether PACKET RESEND support is enabled or disabled.
Supported Optional Commands WRITEMEM	—	True	Display whether WRITEMEM support is enabled or disabled.
Supported Optional Commands Concatenation	—	True	Display whether Concatenation support is enabled or disabled.
Heartbeat Timeout	500 to 4294967295	3000	Set the timeout value for heartbeat.
Timestamp Tick Frequency	—	16000000	Display the timestamp frequency.
Timestamp Control Latch	—	—	Latch the timestamp value.
Timestamp Control Reset	—	—	Reset the timestamp value.

Item	Setting range	Default value	Description
Timestamp Tick Value	—	0	Display the timestamp value.
Control Channel Privilege	—	ControlAccess	Display the control channel privilege.
Message Channel Port	0 to 65535	XXXXX	Set the port number for the message channel.
Message Channel Destination Address	000.000.000.000 to 255.255.255.255	XXX.XXX.XXX.XXX	Set the destination IP address for the message channel.
Message Channel Transmission Timeout (ms)	0 to 4294967295	300	Set the transmission timeout for the message channel. (unit: ms)
Message Channel Retry Count	0 to 4294967295	2	Set the retry count for the message channel.
Message Channel Source Port	—	XXXXX	Display the port number of the message channel source.
Stream Channel Selector	—	0	Select the stream channel.
Stream Channel Port	0 to 4294967295	0	Set the port number for the stream channel.
Do Not Fragment	True, False	True	Enable/disable "Do Not Fragment."
Packet Size	1476 to 16020	1476	Set the packet size.
Packet Delay	0 to 4000000	0	Set the packet delay.
Stream Channel Destination Address	000.000.000.000 to 255.255.255.255	0.0.0.0	Set the destination IP address for the stream channel.
Stream Channel Source Port	—	0	Display the port number of the stream channel source.
<b>j) Action Control</b>			Configure action control settings.
Action Device Key	—	0x00	Set the action device key.
Action Selector	1 to 2	1	Select the action.
Action Group Key	—	0x00	Set the key that executes action 1.
Action Group Mask	—	0x00	Set the mask value that creates the action 0 group.
<b>k) User Set Control</b>			Configure user settings.
User Set Selector	Default, User Set1 to User Set3	Default (factory default values)	Select the user settings.
User Set Load	—	—	Load user settings.
User Set Save	—	—	Save the current setting values as user settings.
<b>l) JAI Custom Control ALC</b>			Configure JAI ALC settings. These settings are also used for AGC (auto gain control).
ALC Reference	10 to 100	50	Set the target level for ALC. (unit: %)
ALC Area Selector	Low Right to High Left	Low Right	Select an ALC metering area.
ALC Area Enable	True, False	False	Enable/disable the metering area where selected metering area.
ALC Area Enable All	0 to 1	1	Set whether to enable ALC for all areas.
ASC Min.	10 to 7999999	10	Set the minimum value for the ASC range.
ASC Max.	101 to 8000000	8000000	Set the maximum value for the ASC range.
AGC Min.	100 to 1599	100	Set the minimum value for the AGC range.
AGC Max.	101 to 1600	1600	Set the maximum value for the AGC range.
AGC/ASC Control Speed	1 to 8	4	Set the reaction speed for AGC/ASC. These settings are also used for auto exposure control.
<b>m) JAI Custom Control Blemish</b>			Configure settings for JAI white blemish correction.
Blemish Enable	True, False	True	Set whether to enable white blemish correction.
Blemish Detect	—	—	Detect white blemishes.
Blemish Detect Threshold	0 to 100	10	Set the white blemish detection threshold.
Blemish Detect Position Index	0 to 255	0	Select the index table for the white blemish detection position.
Blemish Detect Position X	-1 to 1935	-1	Set the horizontal position.
Blemish Detect Position Y	-1 to 1215	-1	Set the vertical position.

Item	Setting range	Default value	Description
<b>n) JAI Custom Control Shading</b>			
Shading Correction Mode	GO-2400M-PGE: Flat Shading (fixed) GO-2400C-PGE: Flat Shading, Color Shading	Flat Shading	Select the shading correction mode.
Shading Mode	Off, User 1, User 2, User 3	Off	Select whether to use shading correction. When using the function, select the user area to which to save the shading correction value.
Perform Shading Calibration	—	—	Execute shading correction. After execution, the shading correction value is automatically saved to the selected user area.
Shading Detect Result	—	—	Display the shading detection results.
<b>o) JAI Custom Control Sequence ROI</b>			
Video Send Mode Selector	Normal Mode, Trigger Sequence Mode, Command Sequence Mode, Multi Mode	Normal Mode	Select the video send mode.
Sequence Roi Index	Index 1 to 128	Index 1	Select the sequence ROI index table.
Sequence Roi Frame Count	1 to 255	1	Set the frame count.
Sequence Roi Next Index	Index 1 to 128, Off	Index 1	Select the next index. When [Off] is selected, sequence operation will stop with this index.
Sequence Roi Width	16 to 1936	1936	Set the width.
Sequence Roi Height	GO-2400M-PGE: 1 to 1216 GO-2400C-PGE: 2 to 1216	1216	Set the height.
Sequence Roi Offset X	—	0	Set the horizontal position.
Sequence Roi Offset Y	—	0	Set the vertical position.
Sequence Roi Gain (GO-2400M-PGE only)	100 to 1600	100	Set the gain value.
Sequence Roi Gain All (GO-2400C-PGE only)	100 to 1600	100	
Sequence Roi Gain Red (GO-2400C-PGE only)	-4533 to 37876	0	
Sequence Roi Gain Blue (GO-2400C-PGE only)	-4533 to 37876	0	
Sequence Roi Exposure Time	38 to 8000000	18000	
Sequence Roi Black Level	0 to 255	0	Set the black level.
Sequence Lut enable	Off, On	Off	Set whether to enable the LUT.
Sequence Roi H Binning (GO-2400M-PGE only)	1 to 2	1	Set the number of pixels in the horizontal direction for which to perform binning.
Sequence Roi V Binning (GO-2400M-PGE only)	1 to 2	1	Set the number of pixels in the vertical direction for which to perform binning.
Sequence Repetition	1 to 255	1	Set the repeat count for the sequence.
Command Sequence Index	Index 1 to 128	Index 1	Set the sequence index command.
Current Sequence Index		Index 1	Display the current sequence index table.
Sequence LUT Mode	Gamma, LUT	Gamma	Set the sequence LUT mode.
Reset Sequence Index	—	—	Reset the sequence index table.

Item	Setting range	Default value	Description
<b>p) JAI Custom Control MultiROI</b>			
Multi Roi Index	Index 1 to 5	Index 1	Set the Multi ROI index table.
Multi Roi Width	16 to 1936/16 steps	1936	Set the width. When binning is enabled on the GO-2400M-PGE, the maximum value will change.
Multi Roi Height	GO-2400M-PGE: 1 to 1216/1 step GO-2400C-PGE: 2 to 1216/2 steps	1216	Set the height. When binning is enabled on the GO-2400M-PGE, the maximum value will change.
Multi Roi Offset X	0 to 1920/16 steps ❖ maximum value = 1936 - width value	0	Set the horizontal position. When binning is enabled on the GO-2400M-PGE, the maximum value will change.
Multi Roi Offset Y	GO-2400M-PGE: 0 to 1215/1 step GO-2400C-PGE: 0 to 1214/2 step ❖ maximum value = 1216 - height value	0	Set the vertical position. When binning is enabled on the GO-2400M-PGE, the maximum value will change.
Multi Roi Index Max	1 to 5	1	Set the Multi ROI index count.
<b>q) JAI Custom Control Sensor MultiROI</b>			
Sensor Multi Roi Index	Index 1 to 4	Index 1	Select the sensor multi ROI index table.
Sensor Multi Roi Width	16 to 1936/16 steps	1936	Set the width. When binning is enabled on the GO-2400M-PGE, the maximum value will change.
Sensor Multi Roi Height	2 to 1216/2 steps	1216	Set the height. When binning is enabled on the GO-2400M-PGE, the maximum value will change.
Sensor Multi Roi Offset X	0 to 1920/16 steps ❖ maximum value = 1936 - width value	0	Set the horizontal position. When binning is enabled on the GO-2400M-PGE, the maximum value will change.
Sensor Multi Roi Offset Y	0 to 1214/2 step ❖ maximum value = 1216 - height value	0	Set the vertical position. When binning is enabled on the GO-2400M-PGE, the maximum value will change.
Horizontal Enable	Off, On	Off	Enable/disable horizontal offset.
Vertical Enable	Off, On	Off	Enable/disable vertical offset.
<b>r) Counter And Timer Control</b>			
Counter 0 to 2	Counter 0 to 2	—	Select the counter.
Counter 0 to 2 Event Source	Off, Frame Trigger, Frame Start, Exposure Start, Exposure Transfer End	Off	Select the counter event signal for which to read the count value.
Counter 0 to 2 Event Activation	Rising Edge (fixed)	Rising Edge	Specify the timing at which to count.
Counter 0 to 2 Reset	—	—	Reset the counter.
Counter 0 to 2 Refresh	—	—	Update the count value.
Counter 0 to 2 Value	—	0	Display the count value.
Counter 0 to 2 Status	—	Counter Active	Display the counter status.
<b>s) JAI Custom control features Misc.</b>			
Video Process Bypass Mode	On, Off	Off	Enable / disable video process bypass mode.
Dark Compression	Linear, Dark Compression	Linear (no compression)	Set whether to compress signals for dark areas.
AWB Area Selector (GO-2400C-PGE only)	Low Right to High Left	Low Right	Select from the 16 metering areas for AWB individually.
AWB Area Enable	True, False	False	Enable (True) / disable (False) the selected AWB metering area.
AWB Control Speed	1 to 8	4	Select the AWB reaction speed. (for continuous)
Binning Gain Enable (GO-2400M-PGE only)	Off, On	On	Enable/disable gain binning.
OptIn Filter Selector	10 us, 100 us, 500 us, 1 ms, 5 ms, 10 ms	10 us	Select the surge protection filter.

## Settings

❖ For details on the setting items, refer to the JAI Control Tool User's Guide

Item	Setting range	Default value
<b>32-bit Factory Transport Layers</b>		
Available 32-bit Transport Layers	—	
JAI_GigE_Vision	—	
Transport name	—	JAI_GigE_Vision
Full path to cti file	—	\$(JAI_SDK_BIN)\JaiGevTL.cti
Enabled	True, False	True
Display name	—	GevTL
<b>64-bit Factory Transport Layers</b>		
Available 64-bit Transport Layers	—	
JAI_GigE_Vision	—	
Transport name	—	JAI_GigE_Vision
Full path to cti file	—	\$(JAI_SDK_BIN_64)\JaiGenTL.cti
Enabled	True, False	True
Display name	—	GenTL
<b>Asynchronous Image Recording</b>		
Recording Count	—	25
Recording Skip Count	—	0
Recording mode	List, CyclicBuffer	List
Optimize the AVI-file creation for Mono8	True, False	True
Prompt user for AVI Encoder	True, False	True
<b>Camera Link Transport Layer</b>		
Automatically probe for CameraLink devices at startup	True, False	True
Use Highest Baud rate for XML download from camera	True, False	False
Show CameraLink Warning Dialog	True, False	True
<b>CXP Transport Layer</b>		
Sync Remote And Local Devices	True, False	True
<b>File Save</b>		
File Format	Tiff, Jpeg, Bmp, Jai, RAW	Tiff
Encoder parameter	—	75
<b>GigE Transport Layer</b>		
Preferred Drive Type	FilterDriver, SocketDriver	FilterDriver
Preferred Device Access Mode	None, ReadOnly, Control	Control
Enable Automatic Force IP	True, False	True
Enable Subnet Conflict Warning?	True, False	True
<b>Look-and-feel</b>		
Visibility Level	Beginner, Expert, Guru	Beginner
HEX display	True, False	False
Display ToolTips	True, False	True
Floating-Point Display Notation	Automatic, Fixed, Scientific	Automatic
Floating-Point Display Precision	—	5
Display the Remote device layer at the top of the tree (transport at the bottom)	True, False	True
Refresh Property Grid After Editing	True, False	False
Override TrackBar Floating-point display precision settings	True, False	False
Make the control tool appear on top of images	True, False	False
Timestamp display format	Ticks, MSec, PTP	Ticks
<b>Plugins</b>		
Search path for plugin DLLs	—	.\plugins
Enable the plug-in button on the menu tab	True, False	False
<b>Support</b>		
Open settings file after save	True, False	True

Item	Setting range	Default value
Support EMail Address	—	camerasupport@jai.com
<b>Logging Properties</b>		
Enable logging	True, False	False
Use custom properties file	True, False	False
Custom logging properties file path		
Output log file path		
Enable GenApi logging	True, False	False
Enable GenTL logging	True, False	False
Enable CIProtocol logging	True, False	False
Enable USB logging	True, False	False
Log Level	FATAL, ALERT, CRIT, ERROR, WARN, NOTICE, INFO, DEBUG, NOTEST	INFO
Format string	—	LOG %d %x: %c : %m%n
Append To Log file	True, False	False
<b>Video Display</b>		
Stretch Live Video	True, False	True
Restore Live Video Window	True, False	True
Skip image display when busy	True, False	True
Enable Color Interpolation	True, False	True
Color Interpolation	BayerStandard, BayerStandardMultiprocessor, BayerExtended, BayerExtendedMultiprocessor, BayerSimple, BayerSimpleMultiprocessor, BayerFast, BayerFastMultiprocessor	BayerStandard
Show Zoom Navigation window	True, False	True
Show Cursor Information window	True, False	False
Enable Mouse Zoom	True, False	True
Enable Mouse Cursor Display	True, False	False



# Miscellaneous

## Troubleshooting

Check the following before requesting help. If the problem persists, contact your local JAI distributor.

### ■ Power supply and connections

Problem	Cause and solution
The power / trigger LED remains lit amber and does not turn green, even after power is supplied to the camera.	Camera initialization may not be complete due to lack of a network connection. Check the LAN cable connection.

### ■ Image display

Problem	Cause and solution
Gradation in dark areas is not noticeable.	Use the gamma function to correct the display. As the light-emitting properties of the monitor are not linear, the entire image may be darker or the gradation in the dark areas may be less noticeable when camera outputs are displayed without processing. Using the gamma function performs correction to produce a display that is close to linear. For details, see “Gamma Function” (page 33).

### ■ Settings and operations

Problem	Cause and solution
Settings cannot be saved to user memory.	You cannot save to user memory while images are being acquired by the camera. Stop image acquisition before performing the save operation.
I want to restore the factory default settings.	Load [Default] under [User Set Selector] in the [Feature Properties] tab to restore the factory default settings.

# Specifications

Item			GO-2400M-PGE	GO-2400C-PGE		
Scanning system			Progressive scan, 1 tap			
Synchronization			Internal			
Interface			1000BASE-T Ethernet (GigE Vision 1.1), IEEE 802.3af			
Image sensor			1/1.2-inch monochrome CMOS	1/1.2-inch Bayer color CMOS		
Image size (effective image)			11.3 (H) × 7.13 (V), 13.4 mm diagonal			
Pixel size			5.86 (H) × 5.86 (V) μm			
Effective image pixel output			1936 (H) × 1216 (V)	1936 (H) × 1216 (V)		
Acquisition Frame Rate (max) ❖ The minimum value is 0.125 fps for all.	8-bit	H1, V1		48.8 fps	48.8 fps	
		Binning	H1, V2		64 fps	—
			H2, V1		64 fps	—
			H2, V2		64 fps	—
	10-bit packed / 12-bit packed	H1, V1		32.6 fps	32.6 fps	
		Binning	H1, V2		32.8 fps	—
			H2, V1		32.8 fps	—
			H2, V2		32.8 fps	—
	10-bit / 12-bit	H1, V1		24.4 fps	24.4 fps	
		Binning	H1, V2		32.8 fps	—
			H2, V1		32.8 fps	—
			H2, V2		32.8 fps	—
EMVA 1288 parameters			At 10-bit output 2.89p (λ = 525 nm) 44.03 dB	At 10-bit output 8.73p (λ = 525 nm) 42.07 dB		
Absolute sensitivity						
Maximum SN ratio						
SN ratio (traditional method)			60 dB or more (typical) (0 dB gain, Black)	60 dB or more (typical) Dark compression ON: 50 dB (typical) (0 dB gain, Green Black)		
Digital image output format	Full pixel		1936 (H) × 1216 (V)	Bayer 1936 (H) × 1216 (V)		
	ROI	Width	16 to 1936, 16 pixels/step	16 to 1936, 16 pixels/step		
		Offset X	0 to 1920, 16 pixels/step	0 to 1920, 16 pixels/step		
		Height	1 to 1216, 1 line/step	2 to 1216, 2 lines/step		
		Offset Y	0 to 1215, 1 line/step	0 to 1214, 2 lines/step		
	Binning	H	1	1936 (H)	1936 (H)	
			2	968 (H)	—	
		V	1	1216 (V)	1216 (V)	
			2	968 (V)	—	
	Pixel Format		Mono8, Mono10, Mono10 Packed, Mono12, Mono12 Packed	BayerGR8, BayerGR10, BayerGR10 Packed, BayerGR12, BayerGR12 Packed		
Acquisition modes			Continuous, Single Frame, Multi Frame (1 to 255)			
Trigger selector	Acquisition		Acquisition Start, Acquisition Stop			
	Exposure		Frame Start			
	Transfer		Acquisition Transfer Start			
Exposure modes			Off, Timed (EPS), Trigger Width (PWC)			
Trigger overlap			Off			
Trigger input signals			Line 5 (Opt In), Software, PG0, NAND Out 0/1, Action 1/2			
Option filter			5 steps (10 μs (Typ), 100 μs, 500 μs, 1ms, 5ms, 10ms)			
Exposure modes	Timed		38 μs (8-bit), 73 μs (10-bit) (min) to 8 s (max), variable unit: 1 μs ❖ Performance verified for up to 1 second.			
	Trigger Width		38 μs (8-bit), 73 μs (10-bit) (min) to ∞ (max) ❖ Performance verified for up to 1 second.			
Auto exposure (Exposure Auto)			Off, Continuous			
Auto exposure response speed (AGC/ASC Control Speed)			1 to 8			
Video Send Mode Selector			Normal ROI, Multi ROI (1 to 5), Trigger Sequence, Command Sequence, Delayed Readout			
Digital I/O			Line Selector (6P): GPIO IN / GPIO OUT			

Item		GO-2400M-PGE	GO-2400C-PGE	
Black level adjustment	Default level	33LSB (during 10-bit output)		
	Video level adjustment range	0 to 100 (during 10-bit output)		
	Adjustment range	-33LSB to +64LSB against reference level (during 10-bit output)		
	Resolution adjustment	1 STEP = 0.25LSB		
Gain adjustment	Manual adjustment range	0 dB to +24 dB 1 step = x0.01 (0.005 dB to 0.08 dB) (varies by setting value)	0 dB to +24 dB 1 step = x0.01 (0.005 dB to 0.08 dB) (varies by setting value)	
	Auto gain	Off, Continuous	Off, Continuous	
	WB gain	—	R / B: -7 dB to +15 dB, 1 step = 0.1 dB	
	WB area	—	16 (4 × 4) Area	
	WB range	—	3000 K to 9000 K	
	White balance	—	Off, Continuous, Once	
Blemish correction	Detection	Detect white blemishes using threshold values (black blemish correction performed only at factory)		
	Correction	Interpolation using adjacent pixels (continuous blemishes not corrected)		
	Correctable pixels	256 pixels		
ALC		Can be adjusted automatically together with AGC and auto exposure		
Gamma		0.45, 0.6 an, 1.0 (OFF) (3 steps available)		
LUT		OFF: $\gamma = 1.0$ , ON = 256 points can be set		
Power supply	6-pin connector	Input range	DC +12 V to +24 V $\pm 10\%$ (via input terminal)	
		Current	220 mA $\pm 20$ mA (at 12 V input, full pixel) (Typical)	
		Current	2.64 W (at 12 V input, full pixel) (Typical)	
	PoE	Input range	DC 36 V to 57 V	
		Current	63 mA $\pm 6$ mA (at 48 V input, full pixel) (Typical)	
		Current	3.02 W (at 48 V input, full pixel) (Typical)	
Lens mount		C-mount Lens mount protrusion length of 9 mm or less is supported		
Flange back		17.526, tolerance: 0 mm to -0.05 m		
Optical filter		Protective glass: Not provided	IR cut filter (half value of 670 nm)	
Verified performance temperature / humidity		-5°C to +45°C / 20% to 80% (non-condensing)		
Storage temperature / humidity		-25°C to +60°C / 20% to 80% (non-condensing)		
Regulations		CE (EN61000-6-2 and EN61000-6-3), FCC part 15 class B, RoHS, WEEE		
Dimensions (housing)		29 × 29 × 41.5 mm (WHD) (excluding mount protrusions)		
Weight		46 g		

Approximately 5 minutes of warm-up are required to achieve these specifications.

### Package contents

Camera body (1)  
Sensor protection cap (1)  
Dear Customer (sheet) (1)

### Optional accessories (not supplied)

MP-43 tripod mount  
AC adapter

Design and specifications are subject to change without notice.

## Frame Rate Reference

(Theoretical value: decimal values are dropped, during Unpacked)

Pixel count	Resolution (screen size)	ROI/Binning	Pixel size( $\mu\text{m}$ )	Image size	Frame rate 8 / 10 / 12 bit
2.35 MP	1936 × 1216	Full pixel	5.86 × 5.86	1/1.2" (13.40 mm)	48.8 fps (@8 bit)
2 MP	1920 × 1080	ROI	5.86 × 5.86	1/1.2" (12.91 mm)	55.5 fps (@8 bit)
1.4 MP	1400 × 1050	ROI	5.86 × 5.86	1/1.6" (10.26 mm)	73.7 fps (@8 bit)
1.3 MP	1280 × 1024	ROI	5.86 × 5.86	1/1.7" (9.61 mm)	75.5 fps (@8 bit)
0.5 MP	800 × 600	ROI	5.86 × 5.86	1/2.7" (5.86 mm)	125.6 fps (@8 bit)
0.3 MP	640 × 480	ROI	5.86 × 5.86	1/3.4" (4.69 mm)	154.5 fps (@8 bit)

## Spectral Response

GO-2400M-PGE

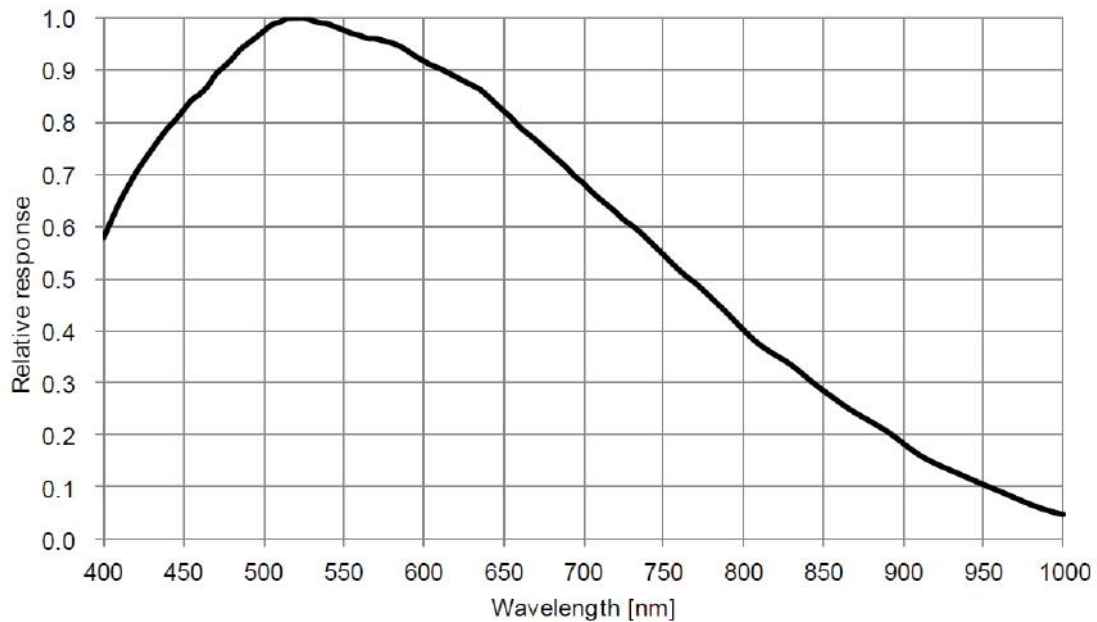

**GO-2400C-PGE**

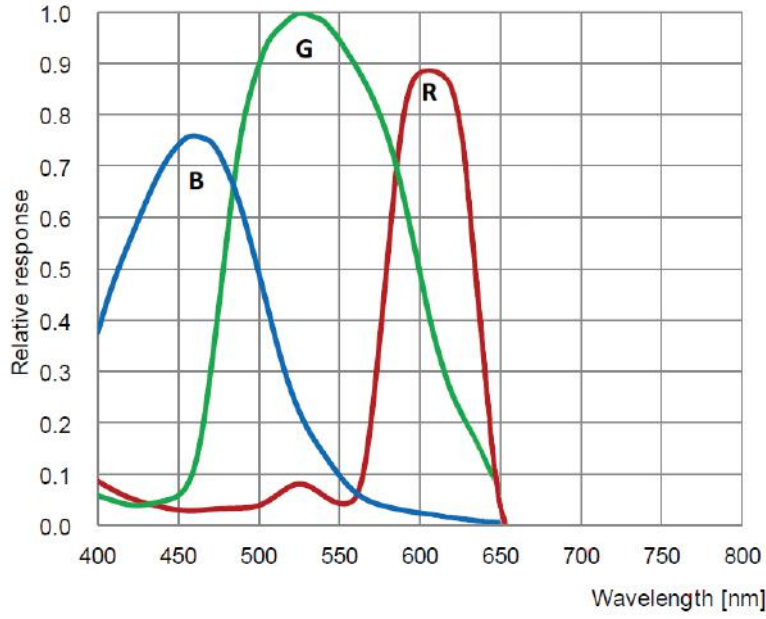

**Dimensions**

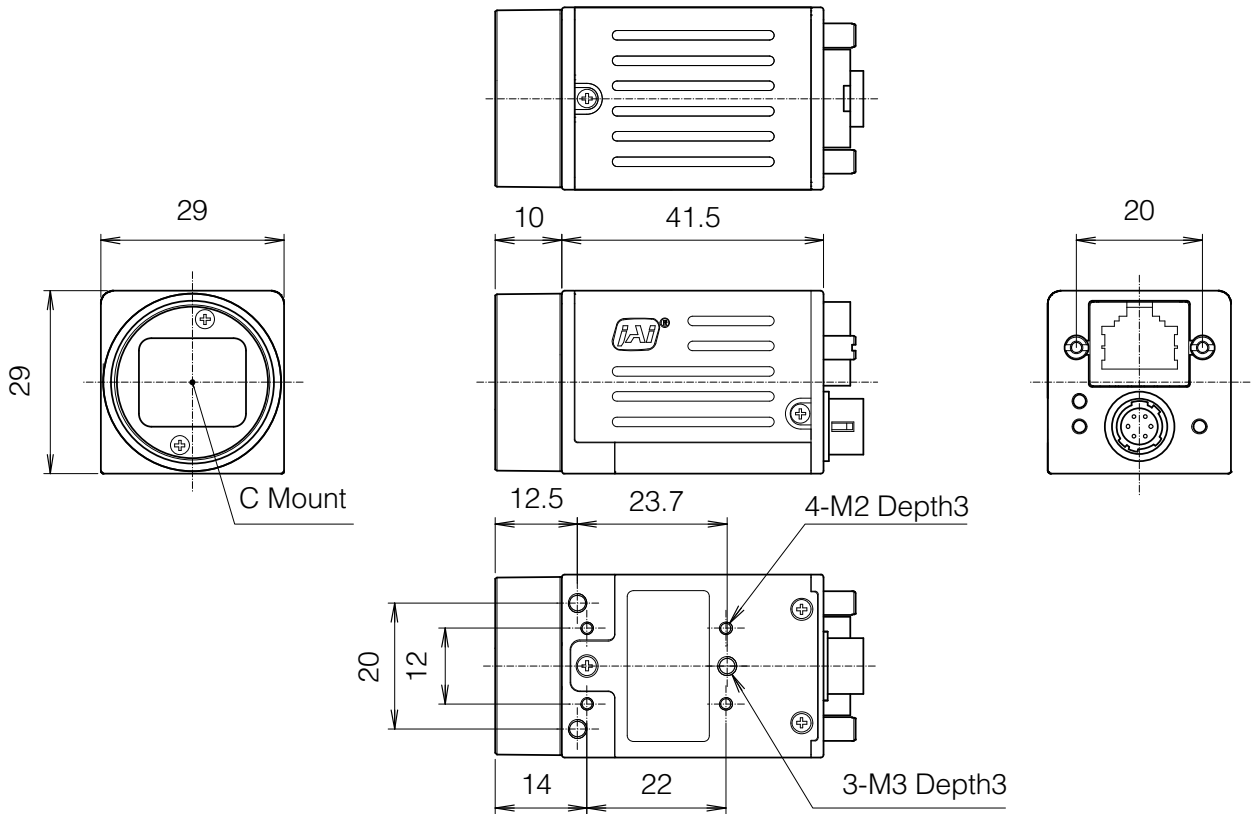

Dimensional tolerance:  $\pm 0.3$  mm  
Unit: mm

## User's Record

**Camera type:** GO-2400M-PGE / GO-2400C-PGE

**Revision:** .....

**Serial No.** .....

**Firmware version.** .....

For camera revision history, please contact your local JAI distributor.

### Trademarks

- GigE Vision is a registered trademark of AIA (Automated Imaging Association).
- Microsoft and Windows are trademarks or registered trademarks of Microsoft Corporation in the United States and other countries.
- Intel and Intel Core are trademarks of Intel Corporation in the United States and other countries.

Other system and product names described in this document are trademarks or registered trademarks of their respective owners. The ™ and ® symbols are not used in this document.

# Index

6-pin round 10

## A

AC adapter 14  
 Acquisition Control 26  
 acquisition modes 26  
 ACT LED 9  
 Adjusting the Black Level 22  
 Adjusting the Gain 21  
 Adjusting the White Balance 21  
 ALC 43  
 Automatic Level Control Function 43

## B

black level 22

## C

Camera locking screw holes 11  
 C-mount 13  
 Configuring Exposure 17  
 Connecting Devices 13  
 Counter and Timer Control Function 45

## D

DC IN 10  
 DC IN / trigger IN connector 10  
 Digital Input/Output Settings 25  
 Dimensions 61

## E

Event Control 30  
 exposure 17  
 Exposure Mode 27  
 External Trigger Settings 17

## F

factory default settings 57  
 Feature Properties 47  
 Frame Rate 26  
 Frame Rate Reference 60

## G

Gain Auto 44  
 Gain Control 31  
 Gain Level 44  
 Gamma Function 33  
 GPIO 25

## I

Initial Settings for the Camera 15  
 Installing the Software 12

## J

JAI Camera Control Tool 12  
 JAI SDK 12

## L

LAN cable 14  
 LED 9  
 Lens 13  
 Lens mount 8  
 LINK LED 9  
 Lookup Table 32  
 LUT 32

## M

Multi ROI 37

## N

Network card 14

## O

Optional accessories (not supplied) 59  
 Output format 16

## P

Parts Identification 8  
 Power/trigger LED 9

## R

Regional Scanning Function 36  
 RJ-45 connector 9  
 ROI 36

## S

Saving the Settings 22  
 Settings 55  
 Settings List 47  
 Shading Correction 34  
 software 12  
 Specifications 58  
 Spectral Response 60

## T

Trigger Control 28  
 trigger IN 10  
 Trigger Selector 28  
 Troubleshooting 57

## V

Verifying the Camera's Network Connection Status 15  
 Video Process Bypass Mode 46

## W

white balance 21