

# Basler ace



## **USER'S MANUAL FOR USB 3.0 CAMERAS**

Document Number: AW001234

Version: 08 Language: 000 (English)

Release Date: 06 July 2016

The manual includes information about the following prototype cameras: acA2040-55, acA2040-120, acA2440-35, and acA2440-75.

### **For customers in the USA**

This equipment has been tested and found to comply with the limits for a Class A digital device, pursuant to Part 15 of the FCC Rules. These limits are designed to provide reasonable protection against harmful interference when the equipment is operated in a commercial environment. This equipment generates, uses, and can radiate radio frequency energy and, if not installed and used in accordance with the instruction manual, may cause harmful interference to radio communications. Operation of this equipment in a residential area is likely to cause harmful interference in which case the user will be required to correct the interference at his own expense.

You are cautioned that any changes or modifications not expressly approved in this manual could void your authority to operate this equipment.

The shielded interface cable recommended in this manual must be used with this equipment in order to comply with the limits for a computing device pursuant to Subpart B of Part 15 of FCC Rules.

### **For customers in Canada**

This apparatus complies with the Class A limits for radio noise emissions set out in Radio Interference Regulations.

### **Pour utilisateurs au Canada**

Cet appareil est conforme aux normes Classe A pour bruits radioélectriques, spécifiées dans le Règlement sur le brouillage radioélectrique.

### **Life Support Applications**

These products are not designed for use in life support appliances, devices, or systems where malfunction of these products can reasonably be expected to result in personal injury. Basler customers using or selling these products for use in such applications do so at their own risk and agree to fully indemnify Basler for any damages resulting from such improper use or sale.

### **Warranty Note**

Do not open the housing of the camera. The warranty becomes void, if the housing is opened.

**All material in this publication is subject to change without notice and is copyright Basler AG.**

## **Contacting Basler Support Worldwide**

### **Europe, Middle East, Africa**

Basler AG

An der Strusbek 60–62

22926 Ahrensburg

Germany

Tel. +49 4102 463 515

Fax +49 4102 463 599

[support.europe@baslerweb.com](mailto:support.europe@baslerweb.com)

### **The Americas**

Basler, Inc.

855 Springdale Drive, Suite 203

Exton, PA 19341

USA

Tel. +1 610 280 0171

Fax +1 610 280 7608

[support.usa@baslerweb.com](mailto:support.usa@baslerweb.com)

### **Asia - Pacific Region**

Basler Asia Pte. Ltd.

35 Marsiling Industrial Estate Road 3

#05–06

Singapore 739257

Tel. +65 6367 1355

Fax +65 6367 1255

[support.asia@baslerweb.com](mailto:support.asia@baslerweb.com)

[www.baslerweb.com](http://www.baslerweb.com)

## Table of Contents

|          |  |           |
|----------|--|-----------|
| <b>1</b> | <b>Specifications, Requirements, and Precautions</b> | <b>1</b>  |
| 1.1      | Models   | 1         |
| 1.2      | Specification Notes                                  | 2         |
| 1.3      | General Specifications                               | 3         |
| 1.3.1    | Cameras with CCD Sensor                              | 3         |
| 1.3.2    | Cameras with CMOS Sensor                             | 7         |
| 1.4      | Spectral Response                                    | 27        |
| 1.4.1    | Mono Camera Spectral Response                        | 27        |
| 1.4.1.1  | Cameras with CCD Sensor                              | 27        |
| 1.4.1.2  | Cameras with CMOS Sensor                             | 29        |
| 1.4.2    | Color Camera Spectral Response                       | 34        |
| 1.4.2.1  | Cameras with CCD Sensor                              | 34        |
| 1.4.2.2  | Cameras with CMOS Sensor                             | 36        |
| 1.5      | Mechanical Specifications                            | 41        |
| 1.5.1    | Camera Dimensions and Mounting Points                | 41        |
| 1.5.2    | Maximum Allowed Lens Thread Length                   | 44        |
| 1.6      | Mounting Instructions                                | 46        |
| 1.6.1    | Tightening Sequence When Using the M2 Screws         | 46        |
| 1.6.2    | Tightening Sequence When Using the M3 Screws         | 47        |
| 1.7      | Mechanical Stress Test Results                       | 48        |
| 1.8      | Software Licensing Information                       | 49        |
| 1.9      | Avoiding EMI and ESD Problems                        | 50        |
| 1.10     | Environmental Requirements                           | 51        |
| 1.10.1   | Temperature and Humidity                             | 51        |
| 1.10.2   | Heat Dissipation                                     | 52        |
| 1.10.3   | Over Temperature Behavior                            | 52        |
| 1.10.3.1 | Monitoring the Internal Temperature                  | 55        |
| 1.11     | Precautions  | 56        |
| <b>2</b> | <b>Installation</b>                                  | <b>60</b> |
| <b>3</b> | <b>Tools for Changing Camera Parameters</b>          | <b>62</b> |
| 3.1      | Basler pylon Camera Software Suite                   | 62        |
| 3.1.1    | pylon Viewer   | 62        |
| 3.1.2    | pylon USB Configurator                               | 63        |
| 3.1.3    | pylon SDKs   | 63        |
| <b>4</b> | <b>Camera Functional Description</b>                 | <b>64</b> |
| 4.1      | Overview for Cameras with CCD Sensor                 | 64        |
| 4.2      | Overview for Cameras with CMOS Sensor                | 66        |

|          |   |           |
|----------|---|-----------|
| <b>5</b> | <b>Physical Interface</b>   | <b>68</b> |
| 5.1      | General Description of the Camera Connections                         | 68        |
| 5.2      | Camera Connector Pin Numbering and Assignments                        | 69        |
| 5.2.1    | 6-pin Connector Pin Numbering and Assignments                         | 69        |
| 5.2.2    | USB 3.0 Micro-B Port Pin Numbering and Assignments                    | 70        |
| 5.3      | Camera Connector Types  | 70        |
| 5.3.1    | 6-pin Connector   | 70        |
| 5.3.2    | USB 3.0 Micro-B Port  | 70        |
| 5.4      | LED Indicator   | 70        |
| 5.5      | Camera Cabling Requirements   | 71        |
| 5.5.1    | USB 3.0 Cable   | 71        |
| 5.5.2    | I/O Cable   | 71        |
| 5.6      | Camera Power  | 73        |
| 5.7      | Opto-isolated Input (Pin 2/Line 1)                                    | 74        |
| 5.7.1    | Electrical Characteristics  | 74        |
| 5.8      | Opto-isolated Output (Pin 4/Line 2)                                   | 77        |
| 5.8.1    | Electrical Characteristics  | 77        |
| 5.9      | Direct-coupled General Purpose I/O (GPIO; Pin 1/Line 3, Pin 3/Line 4) | 80        |
| 5.9.1    | Introduction  | 80        |
| 5.9.2    | Setting a GPIO Line for Input or Output                               | 81        |
| 5.9.3    | Operation as an Input   | 82        |
| 5.9.3.1  | Electrical Characteristics  | 82        |
| 5.9.4    | Operation as an Output  | 84        |
| 5.9.4.1  | Electrical Characteristics  | 84        |
| 5.10     | Temporal Performance of I/O Lines                                     | 86        |
| 5.10.1   | Introduction  | 86        |
| 5.10.2   | Factors Determining I/O Temporal Performance                          | 90        |
| 5.10.3   | Measured Propagation Delays   | 92        |
| 5.11     | Configuring Input Lines and Signals                                   | 93        |
| 5.11.1   | Selecting an Input Line as the Source Signal for a Camera Function    | 93        |
| 5.11.2   | Input Line Debouncers   | 94        |
| 5.11.3   | Input Line Inverter   | 96        |
| 5.12     | Configuring Output Lines and Signals                                  | 97        |
| 5.12.1   | Selecting a Source Signal for an Output Line                          | 97        |
| 5.12.2   | Line Minimum Output Pulse Width                                       | 99        |
| 5.12.3   | Setting the Status of an Individual User Settable Output Line         | 101       |
| 5.12.4   | Setting and Checking the Status of All User Settable Output Lines     | 102       |
| 5.12.5   | Output Line Inverter  | 104       |
| 5.12.6   | Working With the Timer Output Signal                                  | 105       |
| 5.12.6.1 | Setting the Timer Trigger Source                                      | 105       |
| 5.12.6.2 | Setting the Timer Delay Time  | 106       |
| 5.12.6.3 | Setting the Timer Duration Time                                       | 107       |
| 5.13     | Significance of I/O Line Status                                       | 107       |
| 5.13.1   | Line Status for Input Lines   | 107       |
| 5.13.2   | Line Status for Output Lines  | 109       |

|          |  |            |
|----------|--|------------|
| 5.14     | Checking I/O Line Status . . . . .   | 111        |
| 5.14.1   | Checking the Status of All I/O Lines . . . . .   | 111        |
| 5.14.2   | Checking the Status of an Individual I/O Line . . . . .  | 112        |
| <b>6</b> | <b>Image Acquisition Control . . . . .</b>   | <b>113</b> |
| 6.1      | Overview . . . . .   | 113        |
| 6.2      | Acquisition Start and Stop Commands and the Acquisition Mode . . . . .   | 118        |
| 6.3      | The Frame Burst Start Trigger . . . . .  | 120        |
| 6.3.1    | Frame Burst Start Trigger Mode . . . . .   | 120        |
| 6.3.1.1  | Frame Burst Start Trigger Mode = Off . . . . .   | 120        |
| 6.3.1.2  | Frame Burst Start Trigger Mode = On . . . . .  | 120        |
| 6.3.2    | Acquisition Burst Frame Count . . . . .  | 122        |
| 6.3.3    | Setting the Frame Burst Start Trigger Mode and Related Parameters . . . . .  | 123        |
| 6.3.4    | Using a Software Frame Burst Start Trigger . . . . .   | 124        |
| 6.3.4.1  | Introduction . . . . .   | 124        |
| 6.3.4.2  | Setting the Parameters Related to Software Frame Burst Start Triggering and Applying a Software Trigger Signal . . . . . | 125        |
| 6.3.5    | Using a Hardware Frame Burst Start Trigger . . . . .   | 126        |
| 6.3.5.1  | Introduction . . . . .   | 126        |
| 6.3.5.2  | Setting the Parameters Related to Hardware Frame Burst Start Triggering and Applying a Hardware Trigger Signal . . . . . | 127        |
| 6.4      | The Frame Start Trigger . . . . .  | 128        |
| 6.4.1    | Frame Start Trigger Mode . . . . .   | 129        |
| 6.4.1.1  | Frame Start Trigger Mode = Off . . . . .   | 129        |
| 6.4.1.2  | Frame Start Trigger Mode = On . . . . .  | 130        |
| 6.4.1.3  | Setting The Frame Start Trigger Mode and Related Parameters . . . . .  | 131        |
| 6.4.2    | Using a Software Frame Start Trigger . . . . .   | 133        |
| 6.4.2.1  | Introduction . . . . .   | 133        |
| 6.4.2.2  | Setting the Parameters Related to Software Frame Start Triggering and Applying a Software Trigger Signal . . . . .       | 134        |
| 6.4.3    | Using a Hardware Frame Start Trigger . . . . .   | 135        |
| 6.4.3.1  | Introduction . . . . .   | 135        |
| 6.4.3.2  | Exposure Modes . . . . .   | 136        |
| 6.4.3.3  | Frame Start Trigger Delay . . . . .  | 143        |
| 6.4.3.4  | Setting the Parameters Related to Hardware Frame Start Triggering and Applying a Hardware Trigger Signal . . . . .       | 143        |
| 6.5      | Setting the Exposure Time . . . . .  | 145        |
| 6.5.1    | Exposure Times for All Models Except the acA2000-165 and acA2040-90 . . . . .  | 146        |
| 6.5.2    | Exposure Times for the acA2000-165 and acA2040-90 . . . . .  | 147        |
| 6.5.3    | Setting the Parameter Value . . . . .  | 147        |
| 6.6      | Electronic Shutter Operation . . . . .   | 148        |
| 6.6.1    | Global Shutter (All Cameras Except acA1920-25, acA2500-14, acA3800-14, acA4600-10) . . . . .                             | 148        |
| 6.6.1.1  | Sensor Readout Mode . . . . .  | 150        |
| 6.6.2    | Rolling Shutter (acA1920-25, acA2500-14, acA3800-14, acA4600-10 Only) . . . . .  | 151        |
| 6.6.2.1  | Rolling Mode . . . . .   | 151        |
| 6.6.2.2  | Global Reset Release Mode . . . . .  | 154        |

|          |  |            |
|----------|--|------------|
| 6.6.2.3  | The Flash Window . . . . .   | 157        |
| 6.7      | Overlapping Image Acquisitions . . . . .   | 161        |
| 6.7.1    | Overlapping Image Acquisitions for All Models Except acA1920-25,<br>acA2500-14, acA3800-14, acA4600-10 . . . . . | 161        |
| 6.7.2    | Overlapping Image Acquisitions for acA1920-25, acA2500-14,<br>acA3800-14, acA4600-10 . . . . .                   | 164        |
| 6.8      | Acquisition Monitoring Tools . . . . .   | 167        |
| 6.8.1    | Exposure Active Signal . . . . .   | 167        |
| 6.8.2    | Flash Window Signal . . . . .  | 169        |
| 6.8.3    | Acquisition Status Indicator . . . . .   | 171        |
| 6.8.4    | Trigger Wait Signals . . . . .   | 172        |
| 6.8.4.1  | Frame Burst Trigger Wait Signal . . . . .  | 172        |
| 6.8.4.2  | The Frame Trigger Wait Signal . . . . .  | 174        |
| 6.8.5    | Camera Events and Acquisition Status . . . . .   | 179        |
| 6.9      | Acquisition Timing Chart . . . . .   | 180        |
| 6.10     | Maximum Allowed Frame Rate . . . . .   | 184        |
| 6.10.1   | Using Basler pylon to Check the Maximum Allowed Frame Rate . . . . .   | 185        |
| 6.10.2   | Increasing the Maximum Allowed Frame Rate . . . . .  | 186        |
| 6.11     | Use Case Descriptions and Diagrams . . . . .   | 187        |
| <b>7</b> | <b>Features . . . . .</b>  | <b>195</b> |
| 7.1      | Feature Availability Charts . . . . .  | 195        |
| 7.2      | Gain . . . . .   | 198        |
| 7.2.1    | Analog and Digital Control . . . . .   | 198        |
| 7.2.2    | Setting the Gain . . . . .   | 200        |
| 7.3      | Black Level . . . . .  | 203        |
| 7.3.1    | Setting the Black Level . . . . .  | 204        |
| 7.4      | Remove Parameter Limits . . . . .  | 206        |
| 7.5      | Digital Shift . . . . .  | 207        |
| 7.5.1    | Digital Shift with 12 Bit Pixel Formats . . . . .  | 207        |
| 7.5.2    | Digital Shift with 8 Bit Pixel Formats . . . . .   | 209        |
| 7.5.3    | Precautions When Using Digital Shift . . . . .   | 211        |
| 7.5.4    | Enabling and Setting Digital Shift . . . . .   | 212        |
| 7.6      | Image Region of Interest (ROI) . . . . .   | 213        |
| 7.6.1    | Center X and Center Y . . . . .  | 219        |
| 7.6.2    | Changing ROI Parameters "On-the-Fly" . . . . .   | 220        |
| 7.7      | Sequencer . . . . .  | 221        |
| 7.7.1    | Introduction . . . . .   | 221        |
| 7.7.2    | The Sequencer and the Active Set . . . . .   | 222        |
| 7.7.2.1  | Camera Parameters . . . . .  | 223        |
| 7.7.2.2  | Sequencer Set Related Parameters and Sequencer Set Advance . . . . .   | 224        |
| 7.7.3    | Sequencer Configuration . . . . .  | 229        |
| 7.7.3.1  | General Information . . . . .  | 229        |
| 7.7.3.2  | Carrying Out Configuration . . . . .   | 230        |
| 7.7.3.3  | Using the Load Command . . . . .   | 232        |

|          |  |     |
|----------|--|-----|
| 7.7.4    | Sequencer Operation  | 233 |
| 7.7.4.1  | Sequencer Use Case Descriptions and Diagrams                           | 236 |
| 7.8      | Binning  | 250 |
| 7.8.1    | Binning on Monochrome Cameras  | 250 |
| 7.8.2    | Binning on Color Cameras   | 253 |
| 7.8.3    | Setting Binning  | 254 |
| 7.8.4    | Considerations When Using Binning                                      | 256 |
| 7.9      | Decimation   | 258 |
| 7.9.1    | Decimation Vertical (acA3800-14 and acA4600-10 Only)                   | 258 |
| 7.9.2    | Decimation Horizontal (acA3800-14 and acA4600-10 Only)                 | 261 |
| 7.9.3    | Considerations When Using Decimation                                   | 262 |
| 7.10     | Scaling  | 263 |
| 7.10.1   | Considerations When Using Scaling                                      | 264 |
| 7.11     | Mirror Image   | 265 |
| 7.11.1   | Reverse X  | 265 |
| 7.11.2   | Reverse Y  | 268 |
| 7.12     | Luminance Lookup Table   | 271 |
| 7.13     | Gamma Correction   | 275 |
| 7.14     | Color Creation and Enhancement   | 277 |
| 7.14.1   | Color Creation   | 277 |
| 7.14.1.1 | Bayer Color Filter Alignment   | 278 |
| 7.14.1.2 | Pixel Formats Available on Color Cameras                               | 280 |
| 7.14.2   | Integrated IR Cut Filter   | 282 |
| 7.14.3   | Color Enhancement Features   | 283 |
| 7.14.3.1 | Balance White  | 283 |
| 7.14.3.2 | PGI Feature Set  | 286 |
| 7.14.3.3 | Light Source Presets   | 289 |
| 7.14.3.4 | Color Adjustment (All Color Cameras Except acA2000-165 and acA2040-90) | 290 |
| 7.14.3.5 | Color Transformation   | 295 |
| 7.14.3.6 | A Procedure for Setting the Color Enhancements                         | 297 |
| 7.15     | Auto Functions   | 299 |
| 7.15.1   | Common Characteristics   | 299 |
| 7.15.2   | Auto Function Operating Modes  | 300 |
| 7.15.3   | Auto Function ROIs   | 301 |
| 7.15.3.1 | Assignment of an Auto Function to an Auto Function ROI                 | 302 |
| 7.15.3.2 | Positioning of an Auto Function ROI Relative to the Image ROI          | 303 |
| 7.15.3.3 | Setting an Auto Function ROI   | 305 |
| 7.15.4   | Gain Auto  | 307 |
| 7.15.5   | Exposure Auto  | 309 |
| 7.15.6   | Auto Function Profile  | 312 |
| 7.15.7   | Balance White Auto   | 313 |
| 7.15.8   | Pattern Removal Auto   | 314 |
| 7.15.8.1 | Monochrome Cameras   | 314 |
| 7.15.8.2 | Color Cameras  | 317 |
| 7.15.9   | Using an Auto Function   | 317 |



|          |  |            |
|----------|--|------------|
| 7.16     | Timestamp Value .....                                | 318        |
| 7.17     | Event Notification .....                             | 319        |
| 7.18     | Test Images .....                                    | 322        |
| 7.18.1   | Test Image Descriptions .....                        | 324        |
| 7.19     | Device Information Parameters .....                  | 327        |
| 7.20     | User Defined Values .....                            | 330        |
| 7.21     | User Sets .....                                      | 331        |
| 7.21.1   | Selecting a User Set .....                           | 333        |
| 7.21.2   | Saving a User Set .....                              | 334        |
| 7.21.3   | Loading User Set into the Active User Set .....      | 335        |
| 7.21.4   | Designating a User Set as the User Set Default ..... | 336        |
| 7.22     | Line Pitch .....                                     | 338        |
| 7.23     | Chunk Features .....                                 | 342        |
| 7.23.1   | What are Chunk Features? .....                       | 342        |
| 7.23.2   | Using Chunk Features .....                           | 342        |
| 7.23.3   | Data Chunks .....                                    | 343        |
| 7.23.3.1 | Gain Chunk .....                                     | 343        |
| 7.23.3.2 | Line Status All Chunk .....                          | 344        |
| 7.23.3.3 | Exposure Time Chunk .....                            | 345        |
| 7.23.3.4 | Timestamp Chunk .....                                | 346        |
| 7.23.3.5 | Sequencer Set Active Chunk .....                     | 347        |
| 7.23.3.6 | Counter Value Chunk .....                            | 348        |
| 7.23.3.7 | CRC Checksum Chunk .....                             | 350        |
| 7.23.4   | Chunk Mode Active .....                              | 351        |
| 7.23.5   | Retrieving Data Chunks .....                         | 352        |
| <b>8</b> | <b>Troubleshooting and Support .....</b>             | <b>354</b> |
| 8.1      | Tech Support Resources .....                         | 354        |
| 8.2      | Obtaining an RMA Number .....                        | 354        |
| 8.3      | Before Contacting Basler Technical Support .....     | 355        |
|          | <b>Revision History .....</b>                        | <b>358</b> |
|          | <b>Index .....</b>                                   | <b>363</b> |

# 1 Specifications, Requirements, and Precautions

This chapter lists the camera models covered by the manual. It provides the general specifications for those models and the basic requirements for using them.

This chapter also includes specific precautions that you should keep in mind when using the cameras. We strongly recommend that you read and follow the precautions.

## 1.1 Models

The current Basler ace USB 3.0 camera models are listed in the top row of the specification tables on the next pages of this manual. The camera models are differentiated by their sensor size, their maximum frame rate at full or default resolution, and whether the camera's sensor is mono or color.

Unless otherwise noted, the material in this manual applies to all of the camera models listed in the tables. Material that only applies to a particular camera model or to a subset of models, such as to color cameras only, will be so designated.

## 1.2 Specification Notes

### Sensor Size

**Full resolution:** Unless indicated otherwise, the given numbers of pixels refer to the sensor's full resolution. This is also the maximum possible resolution for an image.

**Default resolution:** For some cameras, a slightly decreased resolution is set as the default after camera restart or power up (if one of the factory setups is used). In these cases the default settings for OffsetX and OffsetY may be greater than zero. The decreased resolution is referred to as the "default resolution". If implemented, the default resolution is indicated in the tables below, in addition to full resolution.

When a camera is set to default resolution, you can change to full resolution by making sure OffsetX and OffsetY are set to zero and by setting the Width and Height parameters to the maximum values.

### Max. Frame Rate

"Max. Fame Rate" refers to the maximum allowed frame rate that is possible at default resolution. If no default resolution is implemented, the maximum allowed frame rate refers to camera operation at full resolution.

If a camera can be set for **normal** or **fast** sensor readout mode, maximum allowed frame rates are indicated for both sensor readout modes. If only one maximum allowed frame rate is indicated it implies normal sensor readout.

Special operating conditions may allow cameras to achieve higher frame rates than specified otherwise. In these cases, the maximum frame rates are labeled "**special conditions**" and are given with the applicable special operating conditions.

Note that adverse effects for frame acquisition can occur (e.g. loss of frames) when operating a camera at a "special conditions" frame rate.

For more information about the sensor readout mode, see Section 6.6.1.1 on [page 150](#).

For more information about the maximum allowed frame rate and how to increase it, see Section 6.10 on [page 184](#) and Section 6.10.2 on [page 186](#), respectively.

### Pixel Formats

The indicated Bayer filter alignments refer to the physical alignments of filters with respect to sensors. For most cameras, the physical alignment also holds for the images when the various camera features are used. That is, for most cameras, the physical alignment is identical to the effective alignment. For some cameras, however, the indicated physical Bayer filter alignment is identical to the effective alignment only when neither ReverseX nor ReverseY are enabled. Different effective alignments apply when ReverseX and/or ReverseY are enabled.

For more information about the ReverseX and ReverseY features and related effective Bayer filter alignments, see Section 7.11 on [page 265](#).

## 1.3 General Specifications

### 1.3.1 Cameras with CCD Sensor

| Specification                           | acA640-90um/uc  | acA640-120um/uc   |
|---|---|---|
| Sensor Size<br>(H x V pixels)           | um: 659 x 494<br>uc: 658 x 492  | um: 659 x 494<br>uc: 658 x 492                                |
| Sensor Type                             | Sony ICX424AL/AQ<br>Progressive scan CCD<br>Global shutter  | Sony ICX618 ALA/AQA<br>Progressive scan CCD<br>Global shutter |
| Optical Size                            | 1/3"  | 1/4"  |
| Effective Sensor Diagonal               | 6.1 mm  | 4.7 mm  |
| Pixel Size (H x V)                      | 7.4 $\mu\text{m}$ x 7.4 $\mu\text{m}$   | 5.6 $\mu\text{m}$ x 5.6 $\mu\text{m}$                         |
| Max. Frame Rate<br>(at full resolution) | 100 fps   | 120 fps   |
| Mono/Color                              | Mono or color<br>(color models include a Bayer pattern RGB filter on the sensor)  |   |
| Data Output Type                        | USB 3.0, nominal max. 5 Gbit/s (SuperSpeed)   |   |
| Pixel Formats                           | Mono Models:    Mono 8                      Mono 12p<br>Mono 12<br><br>Color Models:    Mono 8                      RGB 8<br>Bayer BG 8                      BGR 8<br>Bayer BG 12                      YCbCr422_8<br>Bayer BG 12p |   |
| ADC Bit Depth                           | 12 bits   |   |
| Synchronization                         | Via hardware trigger signal, software trigger or free run   |   |
| Exposure Time Control                   | Via hardware trigger signal or programmable via the camera API  |   |
| Camera Power Requirements               | Nominal +5 VDC; SELV and LPS compliant and in accord with the Universal Serial Bus 3.0 specification; supplied via the camera's USB 3.0 port.   |   |
|   | $\approx$ 2.7 W (typical) @ 5 VDC,<br>$\approx$ 3.0 W (max.)  | $\approx$ 2.4 W (typical and max.) @ 5 VDC                    |
| I/O Lines                               | 1 opto-isolated input line, 1 opto-isolated output line, and 2 direct-coupled GPIO lines; power supplies must meet the SELV and LPS requirements  |   |
| Lens Mount                              | C-mount, CS-mount   |   |

Table 1: General Specifications

| Specification    | acA640-90um/uc   | acA640-120um/uc |
|------------------|--|-----------------|
| Size (L x W x H) | 29.3 mm x 29 mm x 29 mm (without cylindric housing extension or connectors)<br>48.2 mm x 29 mm x 29 mm (with cylindric housing extension and connectors)   |                 |
| Weight           | < 80 g   |                 |
| Conformity       | CE, UL Listed, FCC, GenICam V. 2.x (including PFNC V. 2.x and SFNC V. 2.x),<br>IP30, RoHS, USB3 Vision, USB-IF in preparation<br>The CE Conformity Declaration is available on the Basler website:<br><a href="http://www.baslerweb.com">www.baslerweb.com</a> |                 |
| Software         | Basler pylon Camera Software Suite (version 4.0 or higher)<br>Available for Windows (x86, x64) and Linux (x86 32 bit, x86 64 bit, ARM).  |                 |

Table 1: General Specifications

| Specification                           | acA1300-30um/uc   | acA1600-20um/uc   |
|---|---|---|
| Sensor Size<br>(H x V pixels)           | um: 1296 x 966<br>uc: 1294 x 964  | um: 1626 x 1236<br>uc: 1624 x 1234                          |
| Sensor Type                             | Sony ICX445 AL/AQ<br>Progressive scan CCD<br>Global shutter   | Sony ICX274 AL/AQ<br>Progressive scan CCD<br>Global shutter |
| Optical Size                            | 1/3"  | 1/1.8"  |
| Effective Sensor Diagonal               | 6.1 mm  | 9.0 mm  |
| Pixel Size (H x V)                      | 3.75 $\mu\text{m}$ x 3.75 $\mu\text{m}$   | 4.4 $\mu\text{m}$ x 4.4 $\mu\text{m}$                       |
| Max. Frame Rate<br>(at full resolution) | 31 fps  | 20 fps  |
| Mono/Color                              | Mono or color<br>(color models include a Bayer pattern RGB filter on the sensor)  |   |
| Data Output Type                        | USB 3.0, nominal max. 5 Gbit/s (SuperSpeed)   |   |
| Pixel Formats                           | Mono Models:    Mono 8                      Mono 12p<br>Mono 12<br><br>Color Models:    Mono 8                      RGB 8<br>Bayer BG 8                      BGR 8<br>Bayer BG 12                      YCbCr422_8<br>Bayer BG 12p                             |   |
| ADC Bit Depth                           | 12 bits   |   |
| Synchronization                         | Via hardware trigger signal, software trigger or free run   |   |
| Exposure Time Control                   | Via hardware trigger signal or programmable via the camera API  |   |
| Camera Power Requirements               | Nominal +5 VDC; SELV and LPS compliant and in accord with the Universal Serial Bus 3.0 specification; supplied via the camera's USB 3.0 port.   |   |
|   | $\approx 2.5$ W (typical) @ 5 VDC,<br>$\approx 3.0$ W (max.)  | $\approx 3.5$ W (typical and max.) @ 5 VDC                  |
| I/O Lines                               | 1 opto-isolated input line, 1 opto-isolated output line, and 2 direct-coupled GPIO lines; power supplies must meet the SELV and LPS requirements  |   |
| Lens Mount                              | C-mount, CS-mount   |   |
| Size (L x W x H)                        | 29.3 mm x 29 mm x 29 mm (without cylindric housing extension or connectors)<br>48.2 mm x 29 mm x 29 mm (with cylindric housing extension and connectors)  |   |
| Weight                                  | < 80 g  |   |
| Conformity                              | CE, UL Listed, FCC, GenICam V. 2.x (including PFNC V. 2.x and SFNC V. 2.x), IP30, RoHS, USB3 Vision, USB-IF (in preparation)<br>The CE Conformity Declaration is available on the Basler website:<br><a href="http://www.baslerweb.com">www.baslerweb.com</a> |   |

Table 2: General Specifications

| Specification | acA1300-30um/uc   | acA1600-20um/uc |
|---------------|---|-----------------|
| Software      | Basler pylon Camera Software Suite (version 4.0 or higher)<br>Available for Windows (x86, x64) and Linux (x86 32 bit, x86 64 bit, ARM). |                 |

Table 2: General Specifications

## 1.3.2 Cameras with CMOS Sensor

| Specification                              | acA640-750um  | acA640-750uc  |
|--|---|---|
| Sensor Size<br>(H x V pixels)              | 672 x 512 (full resolution)<br>640 x 480 (default resolution; see Section 1.2 on <a href="#">page 2</a> )   |   |
| Sensor Type                                | ON Semiconductor®<br>PYTHON NOIP1SN0300A<br>Progressive scan CMOS<br>Global shutter   | ON Semiconductor®<br>PYTHON NOIP1SE0300A<br>Progressive scan CMOS<br>Global shutter                               |
| Optical Size                               | 1/4"  |   |
| Effective Sensor Diagonal                  | 3.9 mm  |   |
| Pixel Size (H x V)                         | 4.8 µm x 4.8 µm   |   |
| Max. Frame Rate<br>(at default resolution) | 751 fps (at fast sensor readout; see Section 1.2 on <a href="#">page 2</a> )<br>554 fps (at normal sensor readout)  |   |
| Mono/Color                                 | Mono or color (color cameras include a Bayer pattern RGB filter on the sensor)  |   |
| Data Output Type                           | USB 3.0, nominal max. 5 Gbit/s (SuperSpeed)   |   |
| Pixel Formats                              | Mono 8                  Mono 10p<br>Mono 10   | Mono 8                  RGB8<br>Bayer BG 8              BGR8<br>Bayer BG 10            YCbCr422_8<br>Bayer BG 10p |
| Synchronization                            | Via hardware trigger signal, software trigger or free run   |   |
| Exposure Time Control                      | Via hardware trigger signal or programmable via the camera API  |   |
| Camera Power Requirements                  | Nominal +5 VDC; SELV and LPS compliant and in accord with the Universal Serial Bus 3.0 specification; supplied via the camera's USB 3.0 port.   |   |
|  | Mono Models:      ≈ 2.8 W (typical) @ 5 VDC, ≈ 3.1 W (max.)<br>Color Models:     ≈ 3.0 W (typical) @ 5 VDC, ≈ 3.3 W (max.)  |   |
| I/O Lines                                  | 1 opto-isolated input line, 1 opto-isolated output line, and 2 direct-coupled GPIO lines; power supplies must meet the SELV and LPS requirements  |   |
| Lens Mount                                 | C-mount   |   |
| Size (L x W x H)                           | 29.3 mm x 29 mm x 29 mm (without cylindric housing extension or connectors)<br>48.2 mm x 29 mm x 29 mm (with cylindric housing extension and connectors)  |   |
| Weight                                     | < 80 g  |   |
| Conformity                                 | CE, UL in preparation, FCC, GenICam V. 2.x (including PFNC V. 2.x and SFNC V. 2.x), IP30, RoHS, USB3 Vision, USB-IF (in preparation)<br>The CE Conformity Declaration is available on the Basler website:<br><a href="http://www.baslerweb.com">www.baslerweb.com</a> |   |
| Software                                   | Basler pylon Camera Software Suite (version 4.0 or higher)<br>Available for Windows (x86, x64) and Linux (x86 32 bit, x86 64 bit, ARM).   |   |

Table 3: General Specifications



| Specification                              | acA800-510um   | acA800-510uc  |
|--|--|---|
| Sensor Size<br>(H x V pixels)              | 832 x 632 (full resolution)<br>800 x 600 (default resolution; see Section 1.2 on <a href="#">page 2</a> )  |   |
| Sensor Type                                | ON Semiconductor®<br>PYTHON NOIP1SN0500A<br>Progressive scan CMOS<br>Global shutter  | ON Semiconductor®<br>PYTHON NOIP1SE0500A<br>Progressive scan CMOS<br>Global shutter             |
| Optical Size                               | 1/3.3"   |   |
| Effective Sensor Diagonal                  | 4.8 mm   |   |
| Pixel Size (H x V)                         | 4.8 µm x 4.8 µm  |   |
| Max. Frame Rate<br>(at default resolution) | 511 fps (at fast sensor readout; see Section 1.2 on <a href="#">page 2</a> )<br>393 fps (at normal sensor readout)   |   |
| Mono/Color                                 | Mono or color (color cameras include a Bayer pattern RGB filter on the sensor)   |   |
| Data Output Type                           | USB 3.0, nominal max. 5 Gbit/s (SuperSpeed)  |   |
| Pixel Formats                              | Mono 8            Mono 10p<br>Mono 10  | Mono 8            RGB8<br>Bayer BG 8        BGR8<br>Bayer BG 10      YCbCr422_8<br>Bayer BG 10p |
| Synchronization                            | Via hardware trigger signal, software trigger or free run  |   |
| Exposure Time Control                      | Via hardware trigger signal or programmable via the camera API   |   |
| Camera Power Requirements                  | Nominal +5 VDC; SELV and LPS compliant and in accord with the Universal Serial Bus 3.0 specification; supplied via the camera's USB 3.0 port.<br>Mono Models:    ≈ 2.8 W (typical), @ 5 VDC, ≈ 3.1 W (max.)<br>Color Models:    ≈ 3.0 W (typical), @ 5 VDC, ≈ 3.3 W (max.) |   |
| I/O Lines                                  | 1 opto-isolated input line, 1 opto-isolated output line, and 2 direct-coupled GPIO lines; power supplies must meet the SELV and LPS requirements   |   |
| Lens Mount                                 | C-mount  |   |
| Size (L x W x H)                           | 29.3 mm x 29 mm x 29 mm (without cylindric housing extension or connectors)<br>48.2 mm x 29 mm x 29 mm (with cylindric housing extension and connectors)   |   |
| Weight                                     | < 80 g   |   |
| Conformity                                 | CE, UL in preparation, FCC, GenICam V. 2.x (including PFNC V. 2.x and SFNC V. 2.x), IP30, RoHS, USB3 Vision, USB-IF in preparation<br>The CE Conformity Declaration is available on the Basler website:<br><a href="http://www.baslerweb.com">www.baslerweb.com</a>        |   |
| Software                                   | Basler pylon Camera Software Suite (version 4.0 or higher)<br>Available for Windows (x86, x64) and Linux (x86 32 bit, x86 64 bit, ARM).  |   |

Table 4: General Specifications

| Specification                           | acA1300-200um   | acA1300-200uc   |
|---|---|---|
| Sensor Size (H x V pixels)              | 1280 x 1024 (full resolution)   |   |
| Sensor Type                             | ON Semiconductor®<br>PYTHON NOIP1SN1300A<br>Progressive scan CMOS<br>Global shutter   | ON Semiconductor®<br>PYTHON NOIP1SE1300A<br>Progressive scan CMOS<br>Global shutter                               |
| Optical Size                            | 1/2"  |   |
| Effective Sensor Diagonal               | 7.9 mm  |   |
| Pixel Size (H x V)                      | 4.8 µm x 4.8 µm   |   |
| Max. Frame Rate<br>(at full resolution) | 203 fps (at fast sensor readout; see Section 1.2 on <a href="#">page 2</a> )<br>169 fps (at normal sensor readout)  |   |
| Mono/Color                              | Mono or color (color cameras include a Bayer pattern RGB filter on the sensor)  |   |
| Data Output Type                        | USB 3.0, nominal max. 5 Gbit/s (SuperSpeed)   |   |
| Pixel Formats                           | Mono 8                  Mono 10p<br>Mono 10   | Mono 8                  RGB8<br>Bayer BG 8              BGR8<br>Bayer BG 10            YCbCr422_8<br>Bayer BG 10p |
| Synchronization                         | Via hardware trigger signal, software trigger or free run   |   |
| Exposure Time Control                   | Via hardware trigger signal or programmable via the camera API  |   |
| Camera Power Requirements               | Nominal +5 VDC; SELV and LPS compliant and in accord with the Universal Serial Bus 3.0 specification; supplied via the camera's USB 3.0 port.   |   |
|   | Mono Models:      ≈ 2.8 W (typical), @ 5 VDC, ≈ 3.1 W (max.)<br>Color Models:     ≈ 3.0 W (typical), @ 5 VDC, ≈ 3.3 W (max.)  |   |
| I/O Lines                               | 1 opto-isolated input line, 1 opto-isolated output line, and 2 direct-coupled GPIO lines; power supplies must meet the SELV and LPS requirements  |   |
| Lens Mount                              | C-mount   |   |
| Size (L x W x H)                        | 29.3 mm x 29 mm x 29 mm (without cylindric housing extension or connectors)<br>48.2 mm x 29 mm x 29 mm (with cylindric housing extension and connectors)  |   |
| Weight                                  | < 80 g  |   |
| Conformity                              | CE, UL in preparation, FCC, GenICam V. 2.x (including PFNC V. 2.x and SFNC V. 2.x), IP30, RoHS, USB3 Vision, USB-IF in preparation<br>The CE Conformity Declaration is available on the Basler website:<br><a href="http://www.baslerweb.com">www.baslerweb.com</a> |   |
| Software                                | Basler pylon Camera Software Suite (version 4.0 or higher)<br>Available for Windows (x86, x64) and Linux (x86 32 bit, x86 64 bit, ARM).   |   |

Table 5: General Specifications

| Specification                           | acA1920-25um/uc   |
|---|---|
| Sensor Size<br>(H x V pixels)           | um: 1920 x 1080<br>uc: 1920 x 1080  |
| Sensor Type                             | Aptina MT9P031<br>Progressive scan CMOS<br>Rolling shutter  |
| Optical Size                            | 1/3.7"  |
| Effective Sensor Diagonal               | 4.9 mm  |
| Pixel Size (H x V)                      | 2.2 $\mu\text{m}$ x 2.2 $\mu\text{m}$   |
| Max. Frame Rate<br>(at full resolution) | 26 fps  |
| Mono/Color                              | Mono or color<br>(color cameras include a Bayer pattern RGB filter on the sensor)   |
| Data Output Type                        | USB 3.0, nominal max. 5 Gbit/s (SuperSpeed)   |
| Pixel Formats                           | Mono Models: Mono 8 Mono 12p<br>Mono 12<br><br>Color Models: Mono 8 Bayer GB 12p<br>Bayer GB 8 YCbCr422_8<br>Bayer GB 12  |
| Synchronization                         | Via hardware trigger signal, software trigger or free run   |
| Exposure Time Control                   | Programmable via the camera API   |
| Camera Power Requirements               | Nominal +5 VDC; SELV and LPS compliant and in accord with the Universal Serial Bus 3.0 specification; supplied via the camera's USB 3.0 port.<br><br>$\approx 2.2$ W (typical and max.) @ 5 VDC   |
| I/O Lines                               | 1 opto-isolated input line, 1 opto-isolated output line, and 2 direct-coupled GPIO lines; power supplies must meet the SELV and LPS requirements  |
| Lens Mount                              | C-mount   |
| Size (L x W x H)                        | 29.3 mm x 29 mm x 29 mm (without cylindric housing extension or connectors)<br>48.2 mm x 29 mm x 29 mm (with cylindric housing extension and connectors)  |
| Weight                                  | < 80 g  |
| Conformity                              | CE, UL Listed, FCC, GenICam V. 2.x (including PFNC V. 2.x and SFNC V. 2.x), IP30, RoHS, USB3 Vision, USB-IF in preparation<br><br>The CE Conformity Declaration is available on the Basler website:<br><a href="http://www.baslerweb.com">www.baslerweb.com</a> |
| Software                                | Basler pylon Camera Software Suite (version 4.0 or higher)<br>Available for Windows (x86, x64) and Linux (x86 32 bit, x86 64 bit, ARM).   |

Table 6: General Specifications

| Specification                              | acA1920-40um   | acA1920-40uc  |
|--|--|---|
| Sensor Size<br>(H x V pixels)              | 1936 x 1216 (full resolution)<br>1920 x 1200 (default resolution; see Section 1.2 on <a href="#">page 2</a> )  |   |
| Sensor Type                                | Sony IMX249LLJ-C<br>Progressive scan CMOS<br>Global shutter  | Sony IMX249LQJ-C<br>Progressive scan CMOS<br>Global shutter   |
| Optical Size                               | 1/1.2"   |   |
| Effective Sensor Diagonal                  | 13.3 mm  |   |
| Pixel Size (H x V)                         | 5.86 $\mu\text{m}$ x 5.86 $\mu\text{m}$  |   |
| Max. Frame Rate<br>(at default resolution) | 41 fps   |   |
| Mono/Color                                 | Mono or color (color cameras include a Bayer pattern RGB filter on the sensor)   |   |
| Data Output Type                           | USB 3.0, nominal max. 5 Gbit/s (SuperSpeed)  |   |
| Pixel Formats                              | Mono 8                  Mono 12p<br>Mono 12  | Mono 8                  RGB8<br>Bayer RG 8              BGR8<br>Bayer RG 12            YCbCr422_8<br>Bayer RG 12p |
| Synchronization                            | Via hardware trigger signal, software trigger or free run  |   |
| Exposure Time Control                      | Via hardware trigger signal or programmable via the camera API   |   |
| Camera Power Requirements                  | Nominal +5 VDC; SELV and LPS compliant and in accord with the Universal Serial Bus 3.0 specification; supplied via the camera's USB 3.0 port.<br>Mono Models: $\approx 2.5$ W (typical) @ 5 VDC, $\approx 2.7$ W (max.)<br>Color Models: $\approx 2.7$ W (typical) @ 5 VDC, $\approx 2.9$ W (max.) |   |
| I/O Lines                                  | 1 opto-isolated input line, 1 opto-isolated output line, and 2 direct-coupled GPIO lines; power supplies must meet the SELV and LPS requirements   |   |
| Lens Mount                                 | C-mount  |   |
| Size (L x W x H)                           | 29.3 mm x 29 mm x 29 mm (without cylindric housing extension or connectors)<br>48.2 mm x 29 mm x 29 mm (with cylindric housing extension and connectors)   |   |
| Weight                                     | < 80 g   |   |
| Conformity                                 | CE, UL in preparation, FCC, GenICam V. 2.x (including PFNC V. 2.x and SFNC V. 2.x), IP30, RoHS, USB3 Vision, USB-IF in preparation<br>The CE Conformity Declaration is available on the Basler website:<br><a href="http://www.baslerweb.com">www.baslerweb.com</a>                                |   |
| Software                                   | Basler pylon Camera Software Suite (version 4.0 or higher)<br>Available for Windows (x86, x64) and Linux (x86 32 bit, x86 64 bit, ARM).  |   |

Table 7: General Specifications

| Specification                           | acA1920-150um  | acA1920-150uc   |
|---|--|---|
| Sensor Size (H x V pixels)              | 1984 x 1264 (full resolution)<br>1920 x 1200 (default resolution; see Section 1.2 on <a href="#">page 2</a> )  |   |
| Sensor Type                             | ON Semiconductor®<br>PYTHON NOIP1SN2000A<br>Progressive scan CMOS<br>Global shutter  | ON Semiconductor®<br>PYTHON NOIP1SE2000A<br>Progressive scan CMOS<br>Global shutter             |
| Optical Size                            | 2/3"   |   |
| Effective Sensor Diagonal               | 10.9 mm  |   |
| Pixel Size (H x V)                      | 4.8 µm x 4.8 µm  |   |
| Max. Frame Rate<br>(at full resolution) | 150 fps (at fast sensor readout, see Section 1.2 on <a href="#">page 2</a> , and special conditions*)<br>112 fps (at normal sensor readout)  |   |
| Mono/Color                              | Mono or color (color cameras include a Bayer pattern RGB filter on the sensor)   |   |
| Data Output Type                        | USB 3.0, nominal max. 5 Gbit/s (SuperSpeed)  |   |
| Pixel Formats                           | Mono 8            Mono 10p<br>Mono 10  | Mono 8            RGB8<br>Bayer BG 8        BGR8<br>Bayer BG 10      YCbCr422_8<br>Bayer BG 10p |
| Synchronization                         | Via hardware trigger signal, software trigger or free run  |   |
| Exposure Time Control                   | Via hardware trigger signal or programmable via the camera API   |   |
| Camera Power Requirements               | Nominal +5 VDC; SELV and LPS compliant and in accord with the Universal Serial Bus 3.0 specification; supplied via the camera's USB 3.0 port.<br>Mono Models:    ≈ 3.7 W (typical) @ 5 VDC, ≈ 4.0 W (max.)<br>Color Models:    ≈ 3.9 W (typical) @ 5 VDC, ≈ 4.2 W (max.) |   |
| I/O Lines                               | 1 opto-isolated input line, 1 opto-isolated output line, and 2 direct-coupled GPIO lines; power supplies must meet the SELV and LPS requirements   |   |
| Lens Mount                              | C-mount  |   |
| Size (L x W x H)                        | 29.3 mm x 29 mm x 29 mm (without cylindric housing extension or connectors)<br>48.2 mm x 29 mm x 29 mm (with cylindric housing extension and connectors)   |   |
| Weight                                  | < 80 g   |   |
| Conformity                              | CE, UL in preparation, FCC, GenICam V. 2.x (including PFNC V. 2.x and SFNC V. 2.x), IP30, RoHS, USB3 Vision, USB-IF in preparation<br>The CE Conformity Declaration is available on the Basler website:<br><a href="http://www.baslerweb.com">www.baslerweb.com</a>      |   |
| Software                                | Basler pylon Camera Software Suite (version 4.0 or higher)<br>Available for Windows (x86, x64) and Linux (x86 32 bit, x86 64 bit, ARM).  |   |

Table 8: General Specifications

\* This frame rate can be reached when removing the default limit for the DeviceLinkThroughput parameter and allowing approximately 380 MB/s. Note that adverse effects for image acquisition can occur when using a camera at a "special conditions" frame rate. We strongly recommend to only use high-quality accessories. You can obtain them from Basler AG (see the Basler website).

| Specification              | acA1920-155um  | acA1920-155uc   |
|----------------------------|--|---|
| Sensor Size (H x V pixels) | 1936 x 1216 (full resolution)<br>1920 x 1200 (default resolution; see Section 1.2 on <a href="#">page 2</a> )  |   |
| Sensor Type                | Sony IMX174LLJ-C<br>Progressive scan CMOS<br>Global shutter  | Sony IMX174LQJ-C<br>Progressive scan CMOS<br>Global shutter   |
| Optical Size               | 1/1.2"   |   |
| Effective Sensor Diagonal  | 13.4 mm  |   |
| Pixel Size (H x V)         | 5.86 $\mu\text{m}$ x 5.86 $\mu\text{m}$  |   |
| Max. Frame Rate            | 155 fps (at default resolution; see Section 1.2 on <a href="#">page 2</a> )<br>164 fps (special conditions)*   |   |
| Mono/Color                 | Mono or color<br>(color cameras include a Bayer pattern RGB filter on the sensor)  |   |
| Data Output Type           | USB 3.0, nominal max. 5 Gbit/s (SuperSpeed)  |   |
| Pixel Formats              | Mono 8                  Mono 12p<br>Mono 12  | Mono 8                  RGB 8<br>Bayer RG 8              BGR 8<br>Bayer RG 12            YCbCr422_8<br>Bayer RG 12p |
| Synchronization            | Via hardware trigger signal, software trigger or free run  |   |
| Exposure Time Control      | Via hardware trigger signal or programmable via the camera API   |   |
| Camera Power Requirements  | Nominal +5 VDC; SELV and LPS compliant and in accord with the Universal Serial Bus 3.0 specification; supplied via the camera's USB 3.0 port.<br><br>Mono Models: $\approx$ 3.2 W (typical) @ 5 VDC, $\approx$ 3.5 W (max.)<br>Color Models: $\approx$ 3.4 W (typical) @ 5 VDC, $\approx$ 3.7 W (max.) |   |
| I/O Lines                  | 1 opto-isolated input line, 1 opto-isolated output line, and 2 direct-coupled GPIO lines; power supplies must meet the SELV and LPS requirements   |   |
| Lens Mount                 | C-mount  |   |
| Size (L x W x H)           | 29.3 mm x 29 mm x 29 mm (without cylindric housing extension or connectors)<br>48.2 mm x 29 mm x 29 mm (with cylindric housing extension and connectors)   |   |
| Weight                     | < 80 g   |   |
| Conformity                 | CE, UL in preparation, FCC, GenICam V. 2.x (including PFNC V. 2.x and SFNC V. 2.x), IP30, RoHS, USB3 Vision, USB-IF in preparation<br>The CE Conformity Declaration is available on the Basler website:<br><a href="http://www.baslerweb.com">www.baslerweb.com</a>                                    |   |
| Software                   | Basler pylon Camera Software Suite (version 4.0 or higher)<br>Available for Windows (x86, x64) and Linux (x86 32 bit, x86 64 bit, ARM).  |   |

Table 9: General Specifications

\* This frame rate can be reached when removing the default limit for the DeviceLinkThroughput parameter and allowing approximately 380 MB/s. Note that adverse effects for image acquisition can occur when using a camera at a "special conditions" frame rate. We strongly recommend to only use high-quality accessories. You can obtain them from Basler AG (see the Basler website).



| Specification              | acA2000-165um/umNIR  | acA2000-165uc  |
|----------------------------|--|--|
| Sensor Size (H x V pixels) | 2048 x 1088  | 2040 x 1086  |
| Sensor Type                | CMOSIS CMV2000-2E5M/2E12M<br>Progressive scan CMOS<br>Global shutter   | CMOSIS CMV2000-2E5C<br>Progressive scan CMOS<br>Global shutter |
| Optical Size               | 2/3"   |  |
| Effective Sensor Diagonal  | 12.8 mm  |  |
| Pixel Size (H x V)         | 5.5 $\mu\text{m}$ x 5.5 $\mu\text{m}$  |  |
| Max. Frame Rate*           | 168 fps  |  |
| Mono/Mono (NIR)/Color      | Mono or mono (NIR) or color<br>(color models include a Bayer pattern RGB filter on the sensor)   |  |
| Data Output Type           | USB 3.0, nominal max. 5 Gbit/s (SuperSpeed)  |  |
| Pixel Formats              | Mono 8      Mono 12p<br>Mono 12  | Bayer BG 8      Bayer BG 12p<br>Bayer BG 12                    |
| Synchronization            | Via hardware trigger signal, software trigger or free run  |  |
| Exposure Time Control      | Via hardware trigger signal or programmable via the camera API   |  |
| Camera Power Requirements  | Nominal +5 VDC; SELV and LPS compliant and in accord with the Universal Serial Bus 3.0 specification; supplied via the camera's USB 3.0 port.<br><br>$\approx$ 2.9 W (typical) @ 5 VDC, $\approx$ 3.2 W (max.)   |  |
| I/O Lines                  | 1 opto-isolated input line, 1 opto-isolated output line, and 2 direct-coupled GPIO lines; power supplies must meet the SELV and LPS requirements   |  |
| Lens Mount                 | C-mount  |  |
| Size (L x W x H)           | 29.3 mm x 29 mm x 29 mm (without cylindric housing extension or connectors)<br>48.2 mm x 29 mm x 29 mm (with cylindric housing extension and connectors)   |  |
| Weight                     | < 80 g   |  |
| Conformity                 | CE, U Listed, FCC, GenICam V. 2.x (including PFNC V. 2.x and SFNC V. 2.x), IP30, RoHS, USB3 Vision, USB-IF in preparation<br><br>The CE Conformity Declaration is available on the Basler website:<br><a href="http://www.baslerweb.com">www.baslerweb.com</a> |  |
| Software                   | Basler pylon Camera Software Suite (version 4.0 or higher)<br>Available for Windows (x86, x64) and Linux (x86 32 bit, x86 64 bit, ARM).  |  |

Table 10: General Specifications

\* At full resolution and maximum bandwidth

| Specification                 | acA2040-55um  | acA2040-55uc  |
|-------------------------------|---|---|
| Sensor Size<br>(H x V pixels) | 2064 x 1544 (full resolution)<br>2048 x 1536 (default resolution; see Section 1.2 on <a href="#">page 2</a> )   |   |
| Sensor Type                   | Sony IMX265LLR-C<br>Progressive scan CMOS<br>Global shutter   | Sony IMX265LQR-C<br>Progressive scan CMOS<br>Global shutter   |
| Optical Size                  | 1/1.8"  |   |
| Effective Sensor Diagonal     | 8.9 mm  |   |
| Pixel Size (H x V)            | 3.45 $\mu\text{m}$ x 3.45 $\mu\text{m}$   |   |
| Max. Frame Rate               | 55 fps (at default and full resolution; see Section 1.2 on <a href="#">page 2</a> )   |   |
| Mono/Color                    | Mono or color<br>(color cameras include a Bayer pattern RGB filter on the sensor)   |   |
| Data Output Type              | USB 3.0, nominal max. 5 Gbit/s (SuperSpeed)   |   |
| Pixel Formats                 | Mono 8                  Mono 12p<br>Mono 12   | Mono 8                  RGB 8<br>Bayer RG 8              BGR 8<br>Bayer RG 12            YCbCr422_8<br>Bayer RG 12p |
| Synchronization               | Via hardware trigger signal, software trigger or free run   |   |
| Exposure Time Control         | Via hardware trigger signal or programmable via the camera API  |   |
| Camera Power Requirements     | Nominal +5 VDC; SELV and LPS compliant and in accord with the Universal Serial Bus 3.0 specification; supplied via the camera's USB 3.0 port.   |   |
|                               | Mono Models: $\approx 2.5$ W (typical) @ 5 VDC<br>Color Models: $\approx 2.6$ W (typical) @ 5 VDC   |   |
| I/O Lines                     | 1 opto-isolated input line, 1 opto-isolated output line, and 2 direct-coupled GPIO lines; power supplies must meet the SELV and LPS requirements  |   |
| Lens Mount                    | C-mount   |   |
| Size (L x W x H)              | 29.3 mm x 29 mm x 29 mm (without cylindric housing extension or connectors)<br>48.2 mm x 29 mm x 29 mm (with cylindric housing extension and connectors)  |   |
| Weight                        | < 80 g  |   |
| Conformity                    | CE, UL in preparation, FCC, GenICam V. 2.x (including PFNC V. 2.x and SFNC V. 2.x), IP30, RoHS, USB3 Vision, USB-IF in preparation<br>The CE Conformity Declaration is available on the Basler website:<br><a href="http://www.baslerweb.com">www.baslerweb.com</a> |   |
| Software                      | Basler pylon Camera Software Suite (version 4.0 or higher)<br>Available for Windows (x86, x64) and Linux (x86 32 bit, x86 64 bit, ARM).   |   |

Table 11: General Specifications

| Specification              | acA2040-90um/umNIR  | acA2040-90uc   |
|----------------------------|---|--|
| Sensor Size (H x V pixels) | 2048 x 2048   | 2040 x 2046  |
| Sensor Type                | CMOSIS CMV4000-2E5M/2E12M<br>Progressive scan CMOS<br>Global shutter  | CMOSIS CMV4000-2E5C<br>Progressive scan CMOS<br>Global shutter |
| Optical Size               | 1"  |  |
| Effective Sensor Diagonal  | 16.0 mm   |  |
| Pixel Size (H x V)         | 5.5 $\mu\text{m}$ x 5.5 $\mu\text{m}$   |  |
| Max. Frame Rate*           | 90 fps  |  |
| Mono/Mono (NIR)/Color      | Mono or mono (NIR) or color<br>(color models include a Bayer pattern RGB filter on the sensor)  |  |
| Data Output Type           | USB 3.0, nominal max. 5 Gbit/s (SuperSpeed)   |  |
| Pixel Formats              | Mono 8          Mono 12p<br>Mono 12   | Bayer BG 8          Bayer BG 12p<br>Bayer BG 12                |
| Synchronization            | Via hardware trigger signal, software trigger or free run   |  |
| Exposure Time Control      | Via hardware trigger signal or programmable via the camera API  |  |
| Camera Power Requirements  | Nominal +5 VDC; SELV and LPS compliant and in accord with the Universal Serial Bus 3.0 specification; supplied via the camera's USB 3.0 port.<br><br>$\approx$ 2.9 W (typical) @ 5 VDC, $\approx$ 3.2 W (max.)  |  |
| I/O Lines                  | 1 opto-isolated input line, 1 opto-isolated output line, and 2 direct-coupled GPIO lines; power supplies must meet the SELV and LPS requirements  |  |
| Lens Mount                 | C-mount   |  |
| Size (L x W x H)           | 29.3 mm x 29 mm x 29 mm (without cylindric housing extension or connectors)<br>48.2 mm x 29 mm x 29 mm (with cylindric housing extension and connectors)  |  |
| Weight                     | < 80 g  |  |
| Conformity                 | CE, UL Listed, FCC, GenICam V. 2.x (including PFNC V. 2.x and SFNC V. 2.x), IP30, RoHS, USB3 Vision, USB-IF in preparation<br>The CE Conformity Declaration is available on the Basler website:<br><a href="http://www.baslerweb.com">www.baslerweb.com</a> |  |
| Software                   | Basler pylon Camera Software Suite (version 4.0 or higher)<br>Available for Windows (x86, x64) and Linux (x86 32 bit, x86 64 bit, ARM).   |  |

Table 12: General Specifications

\* At full resolution and maximum bandwidth

| Specification                 | acA2040-120um   | acA2040-120uc   |
|-------------------------------|---|---|
| Sensor Size<br>(H x V pixels) | 2064 x 1544 (full resolution)<br>2048 x 1536 (default resolution; see Section 1.2 on <a href="#">page 2</a> )   |   |
| Sensor Type                   | Sony IMX252LLR-C<br>Progressive scan CMOS<br>Global shutter   | Sony IMX252LQR-C<br>Progressive scan CMOS<br>Global shutter   |
| Optical Size                  | 1/1.8"  |   |
| Effective Sensor Diagonal     | 8.9 mm  |   |
| Pixel Size (H x V)            | 3.45 $\mu\text{m}$ x 3.45 $\mu\text{m}$   |   |
| Max. Frame Rate               | 119 fps (at full resolution and special conditions)*<br>120 fps (at default resolution and special conditions; see Section 1.2 on <a href="#">page 2</a> )*   |   |
| Mono/Color                    | Mono or color<br>(color cameras include a Bayer pattern RGB filter on the sensor)   |   |
| Data Output Type              | USB 3.0, nominal max. 5 Gbit/s (SuperSpeed)   |   |
| Pixel Formats                 | Mono 8                  Mono 12p<br>Mono 12   | Mono 8                  RGB 8<br>Bayer RG 8              BGR 8<br>Bayer RG 12            YCbCr422_8<br>Bayer RG 12p |
| Synchronization               | Via hardware trigger signal, software trigger or free run   |   |
| Exposure Time Control         | Via hardware trigger signal or programmable via the camera API  |   |
| Camera Power Requirements     | Nominal +5 VDC; SELV and LPS compliant and in accord with the Universal Serial Bus 3.0 specification; supplied via the camera's USB 3.0 port.<br><br>Mono Models: $\approx$ 3.1 W (typical) @ 5 VDC<br>Color Models: $\approx$ 3.5 W (typical) @ 5 VDC              |   |
| I/O Lines                     | 1 opto-isolated input line, 1 opto-isolated output line, and 2 direct-coupled GPIO lines; power supplies must meet the SELV and LPS requirements  |   |
| Lens Mount                    | C-mount   |   |
| Size (L x W x H)              | 29.3 mm x 29 mm x 29 mm (without cylindric housing extension or connectors)<br>48.2 mm x 29 mm x 29 mm (with cylindric housing extension and connectors)  |   |
| Weight                        | < 80 g  |   |
| Conformity                    | CE, UL in preparation, FCC, GenICam V. 2.x (including PFNC V. 2.x and SFNC V. 2.x), IP30, RoHS, USB3 Vision, USB-IF in preparation<br>The CE Conformity Declaration is available on the Basler website:<br><a href="http://www.baslerweb.com">www.baslerweb.com</a> |   |
| Software                      | Basler pylon Camera Software Suite (version 4.0 or higher)<br>Available for Windows (x86, x64) and Linux (x86 32 bit, x86 64 bit, ARM).   |   |

Table 13: General Specifications

\* This frame rate can be reached when removing the default limit for the DeviceLinkThroughput parameter and allowing approximately 380 MB/s. Note that adverse effects for image acquisition can occur when using a camera at a "special conditions" frame rate. We strongly recommend to only use high-quality accessories. You can obtain them from Basler AG (see the Basler website).

| Specification              | acA2440-35um  | acA2440-35uc  |
|----------------------------|---|---|
| Sensor Size (H x V pixels) | 2464 x 2056 (full resolution)<br>2448 x 2048 (default resolution; see Section 1.2 on <a href="#">page 2</a> )   |   |
| Sensor Type                | Sony IMX264LLR-C<br>Progressive scan CMOS<br>Global shutter   | Sony IMX264LQR-C<br>Progressive scan CMOS<br>Global shutter   |
| Optical Size               | 2/3"  |   |
| Effective Sensor Diagonal  | 11.1 mm   |   |
| Pixel Size (H x V)         | 3.45 $\mu\text{m}$ x 3.45 $\mu\text{m}$   |   |
| Max. Frame Rate            | 35 fps (at default resolution; see Section 1.2 on <a href="#">page 2</a> )*   |   |
| Mono/Color                 | Mono or color<br>(color cameras include a Bayer pattern RGB filter on the sensor)   |   |
| Data Output Type           | USB 3.0, nominal max. 5 Gbit/s (SuperSpeed)   |   |
| Pixel Formats              | Mono 8                  Mono 12p<br>Mono 12   | Mono 8                  RGB 8<br>Bayer RG 8              BGR 8<br>Bayer RG 12            YCbCr422_8<br>Bayer RG 12p |
| Synchronization            | Via hardware trigger signal, software trigger or free run   |   |
| Exposure Time Control      | Via hardware trigger signal or programmable via the camera API  |   |
| Camera Power Requirements  | Nominal +5 VDC; SELV and LPS compliant and in accord with the Universal Serial Bus 3.0 specification; supplied via the camera's USB 3.0 port.   |   |
|                            | Mono Models: $\approx 2.5$ W (typical) @ 5 VDC<br>Color Models: $\approx 2.7$ W (typical) @ 5 VDC   |   |
| I/O Lines                  | 1 opto-isolated input line, 1 opto-isolated output line, and 2 direct-coupled GPIO lines; power supplies must meet the SELV and LPS requirements  |   |
| Lens Mount                 | C-mount   |   |
| Size (L x W x H)           | 29.3 mm x 29 mm x 29 mm (without cylindric housing extension or connectors)<br>48.2 mm x 29 mm x 29 mm (with cylindric housing extension and connectors)  |   |
| Weight                     | < 80 g  |   |
| Conformity                 | CE, UL in preparation, FCC, GenICam V. 2.x (including PFNC V. 2.x and SFNC V. 2.x), IP30, RoHS, USB3 Vision, USB-IF in preparation<br>The CE Conformity Declaration is available on the Basler website:<br><a href="http://www.baslerweb.com">www.baslerweb.com</a> |   |
| Software                   | Basler pylon Camera Software Suite (version 4.0 or higher)<br>Available for Windows (x86, x64) and Linux (x86 32 bit, x86 64 bit, ARM).   |   |

Table 14: General Specifications

| Specification              | acA2440-75um  | acA2440-75uc  |
|----------------------------|---|---|
| Sensor Size (H x V pixels) | 2464 x 2056 (full resolution)<br>2448 x 2048 (default resolution; see Section 1.2 on <a href="#">page 2</a> )   |   |
| Sensor Type                | Sony IMX250LLR-C<br>Progressive scan CMOS<br>Global shutter   | Sony IMX250LQR-C<br>Progressive scan CMOS<br>Global shutter   |
| Optical Size               | 2/3"  |   |
| Effective Sensor Diagonal  | 11.1 mm   |   |
| Pixel Size (H x V)         | 3.45 $\mu\text{m}$ x 3.45 $\mu\text{m}$   |   |
| Max. Frame Rate            | 75 fps (at default resolution; see Section 1.2 on <a href="#">page 2</a> )  |   |
| Mono/Color                 | Mono or color<br>(color cameras include a Bayer pattern RGB filter on the sensor)   |   |
| Data Output Type           | USB 3.0, nominal max. 5 Gbit/s (SuperSpeed)   |   |
| Pixel Formats              | Mono 8                  Mono 12p<br>Mono 12   | Mono 8                  RGB 8<br>Bayer RG 8              BGR 8<br>Bayer RG 12            YCbCr422_8<br>Bayer RG 12p |
| Synchronization            | Via hardware trigger signal, software trigger or free run   |   |
| Exposure Time Control      | Via hardware trigger signal or programmable via the camera API  |   |
| Camera Power Requirements  | Nominal +5 VDC; SELV and LPS compliant and in accord with the Universal Serial Bus 3.0 specification; supplied via the camera's USB 3.0 port.<br><br>Mono Models: $\approx$ 3.2 W (typical) @ 5 VDC<br>Color Models: $\approx$ 3.4 W (typical) @ 5 VDC              |   |
| I/O Lines                  | 1 opto-isolated input line, 1 opto-isolated output line, and 2 direct-coupled GPIO lines; power supplies must meet the SELV and LPS requirements  |   |
| Lens Mount                 | C-mount   |   |
| Size (L x W x H)           | 29.3 mm x 29 mm x 29 mm (without cylindric housing extension or connectors)<br>48.2 mm x 29 mm x 29 mm (with cylindric housing extension and connectors)  |   |
| Weight                     | < 80 g  |   |
| Conformity                 | CE, UL in preparation, FCC, GenICam V. 2.x (including PFNC V. 2.x and SFNC V. 2.x), IP30, RoHS, USB3 Vision, USB-IF in preparation<br>The CE Conformity Declaration is available on the Basler website:<br><a href="http://www.baslerweb.com">www.baslerweb.com</a> |   |
| Software                   | Basler pylon Camera Software Suite (version 4.0 or higher)<br>Available for Windows (x86, x64) and Linux (x86 32 bit, x86 64 bit, ARM).   |   |

Table 15: General Specifications

| Specification                           | acA2500-14um/uc   |
|---|---|
| Sensor Size<br>(H x V pixels)           | um: 2592 x 1944<br>uc: 2590 x 1942  |
| Sensor Type                             | Aptina MT9P031<br>Progressive scan CMOS<br>Rolling shutter  |
| Optical Size                            | 1/2.5"  |
| Effective Sensor Diagonal               | 7.2 mm  |
| Pixel Size (H x V)                      | 2.2 $\mu\text{m}$ x 2.2 $\mu\text{m}$   |
| Max. Frame Rate<br>(at full resolution) | 14 fps  |
| Mono/Color                              | Mono or color (color models include a Bayer pattern RGB filter on the sensor)   |
| Data Output Type                        | USB 3.0, nominal max. 5 Gbit/s (SuperSpeed)   |
| Pixel Formats                           | Mono Models: Mono 8 Mono 12p<br>Mono 12<br><br>Color Models: Mono 8 Bayer GB 12p<br>Bayer GB 8 YCbCr422_8<br>Bayer GB 12  |
| Synchronization                         | Via hardware trigger signal, software trigger or free run   |
| Exposure Time Control                   | Programmable via the camera API   |
| Camera Power Requirements               | Nominal +5 VDC; SELV and LPS compliant and in accord with the Universal Serial Bus 3.0 specification; supplied via the camera's USB 3.0 port<br><br>$\approx 2.2$ W (typical and max.) @ 5 VDC  |
| I/O Lines                               | 1 opto-isolated input line, 1 opto-isolated output line, and 2 direct-coupled GPIO lines; power supplies must meet the SELV and LPS requirements  |
| Lens Mount                              | C-mount, CS-mount   |
| Size (L x W x H)                        | 29.3 mm x 29 mm x 29 mm (without cylindric housing extension or connectors)<br>48.2 mm x 29 mm x 29 mm (with cylindric C-mt. housing extension and connectors)  |
| Weight                                  | < 80 g  |
| Conformity                              | CE, UL Listed, FCC, GenICam V. 2.x (including PFNC V. 2.x and SFNC V. 2.x), IP30, RoHS, USB3 Vision, USB-IF in preparation<br><br>The CE Conformity Declaration is available on the Basler website:<br><a href="http://www.baslerweb.com">www.baslerweb.com</a> |
| Software                                | Basler pylon Camera Software Suite (version 4.0 or higher)<br>Available for Windows (x86, x64) and Linux (x86 32 bit, x86 64 bit, ARM).   |

Table 16: General Specifications



| Specification                           | acA2500-60um   | acA2500-60uc  |
|---|--|---|
| Sensor Size (H x V pixels)              | 2592 x 2048  |   |
| Sensor Type                             | ON Semiconductor®<br>PYTHON NOIP1SN5000A<br>Progressive scan CMOS<br>Global shutter  | ON Semiconductor®<br>PYTHON NOIP1SE5000A<br>Progressive scan CMOS<br>Global shutter                               |
| Optical Size                            | 1"   |   |
| Effective Sensor Diagonal               | 15.9 mm  |   |
| Pixel Size (H x V)                      | 4.8 µm x 4.8 µm  |   |
| Max. Frame Rate<br>(at full resolution) | 60 fps (at fast sensor readout, see Section 1.2 on <a href="#">page 2</a> , and special conditions)*<br>47 fps (at normal sensor readout and at special conditions)*   |   |
| Mono/Color                              | Mono or color (color cameras include a Bayer pattern RGB filter on the sensor)   |   |
| Data Output Type                        | USB 3.0, nominal max. 5 Gbit/s (SuperSpeed)  |   |
| Pixel Formats                           | Mono 8                  Mono 10p<br>Mono 10  | Mono 8                  RGB8<br>Bayer BG 8              BGR8<br>Bayer BG 10            YCbCr422_8<br>Bayer BG 10p |
| Synchronization                         | Via hardware trigger signal, software trigger or free run  |   |
| Exposure Time Control                   | Via hardware trigger signal or programmable via the camera API   |   |
| Camera Power Requirements               | Nominal +5 VDC; SELV and LPS compliant and in accord with the Universal Serial Bus 3.0 specification; supplied via the camera's USB 3.0 port.<br><br>Mono Models:        ≈ 3.6 W (typical) @ 5 VDC, ≈ 3.9 W (max.)<br>Color Models:        ≈ 3.8 W (typical) @ 5 VDC, ≈ 4.1 W (max.) |   |
| I/O Lines                               | 1 opto-isolated input line, 1 opto-isolated output line, and 2 direct-coupled GPIO lines; power supplies must meet the SELV and LPS requirements   |   |
| Lens Mount                              | C-mount  |   |
| Size (L x W x H)                        | 29.3 mm x 29 mm x 29 mm (without cylindric housing extension or connectors)<br>48.2 mm x 29 mm x 29 mm (with cylindric housing extension and connectors)   |   |
| Weight                                  | < 80 g   |   |
| Conformity                              | CE, UL in preparation, FCC, GenICam V. 2.x (including PFNC V. 2.x and SFNC V. 2.x), IP30, RoHS, USB3 Vision, USB-IF in preparation<br>The CE Conformity Declaration is available on the Basler website:<br><a href="http://www.baslerweb.com">www.baslerweb.com</a>                  |   |
| Software                                | Basler pylon Camera Software Suite (version 4.0 or higher)<br>Available for Windows (x86, x64) and Linux (x86 32 bit, x86 64 bit, ARM).  |   |

Table 17: General Specifications

\* This frame rate can be reached when removing the default limit for the DeviceLinkThroughput parameter and allowing approximately 380 MB/s. Note that adverse effects for image acquisition can occur when using a camera at a "special conditions" frame rate. We strongly recommend to only use high-quality accessories. You can obtain them from Basler AG (see the Basler website).

| Specification                 | acA3800-14um/uc  | acA4600-10uc  |
|-------------------------------|--|---|
| Sensor Size<br>(H x V pixels) | um: 3840 x 2748<br>uc: 3840 x 2748   | uc: 4608 x 3288   |
| Sensor Type                   | Aptina MT9J003<br>Progressive scan CMOS<br>Rolling shutter   | Aptina MT9F002<br>Progressive scan CMOS<br>Rolling shutter                                    |
| Optical Size                  | 1/2.3"   |   |
| Effective Sensor Diagonal     | 7.9 mm   | 8.0 mm  |
| Pixel Size (H x V)            | 1.67 $\mu\text{m}$ x 1.67 $\mu\text{m}$  | 1.4 $\mu\text{m}$ x 1.4 $\mu\text{m}$   |
| Max. Frame Rate               | 14 fps (at full resolution)  | 10 fps (at full resolution)   |
| Mono/Color                    | Mono or color (color models include a Bayer pattern RGB filter on the sensor)  | Color (includes a Bayer pattern RGB filter on the sensor)                                     |
| Data Output Type              | USB 3.0, nominal max. 5 Gbit/s (SuperSpeed)  |   |
| Pixel Formats                 | Mono Model:<br>Mono 8            Mono 12p<br>Mono 12<br><br>Color Model:<br>Mono 8            Bayer BG 12p<br>Bayer BG 8        YCbCr422_8<br>Bayer BG 12  | Color Model:<br>Mono 8            Bayer BG 12p<br>Bayer BG 8        YCbCr422_8<br>Bayer BG 12 |
| Synchronization               | Via hardware trigger signal, software trigger or free run  |   |
| Exposure Time Control         | Programmable via the camera API  |   |
| Camera Power Requirements     | Nominal +5 VDC; SELV and LPS compliant and in accord with the Universal Serial Bus 3.0 specification; supplied via the camera's USB 3.0 port<br>$\approx 2.5$ W (typical) @ 5 VDC, $\approx 2.8$ W (max.)  |   |
| I/O Lines                     | 1 opto-isolated input line, 1 opto-isolated output line, 2 direct-coupled GPIO lines; power supplies must meet the SELV and LPS requirements   |   |
| Lens Mount                    | C-mount, CS-mount  | C-mount   |
| Size (L x W x H)              | 29.3 mm x 29 mm x 29 mm (without cylindrical housing extension or connectors)<br>48.2 mm x 29 mm x 29 mm (with cylindrical C-mt. housing extension and connectors)   |   |
| Weight                        | < 80 g   |   |
| Conformity                    | CE, UL Listed, FCC, GenICam V. 2.x (including PFNC V. 2.x and SFNC V. 2.x), IP30, RoHS, USB3 Vision, USB-IF in preparation<br>The CE Conformity Declaration is available on the Basler website: <a href="http://www.baslerweb.com">www.baslerweb.com</a> |   |
| Software                      | Basler pylon Camera Software Suite (version 4.0 or higher)<br>Available for Windows (x86, x64) and Linux (x86 32 bit, x86 64 bit, ARM).  |   |

Table 18: General Specifications

## 1.4 Spectral Response

### 1.4.1 Mono Camera Spectral Response

The following graphs show the spectral response for each available monochrome camera model.



The spectral response curves exclude lens characteristics and light source characteristics.

#### 1.4.1.1 Cameras with CCD Sensor

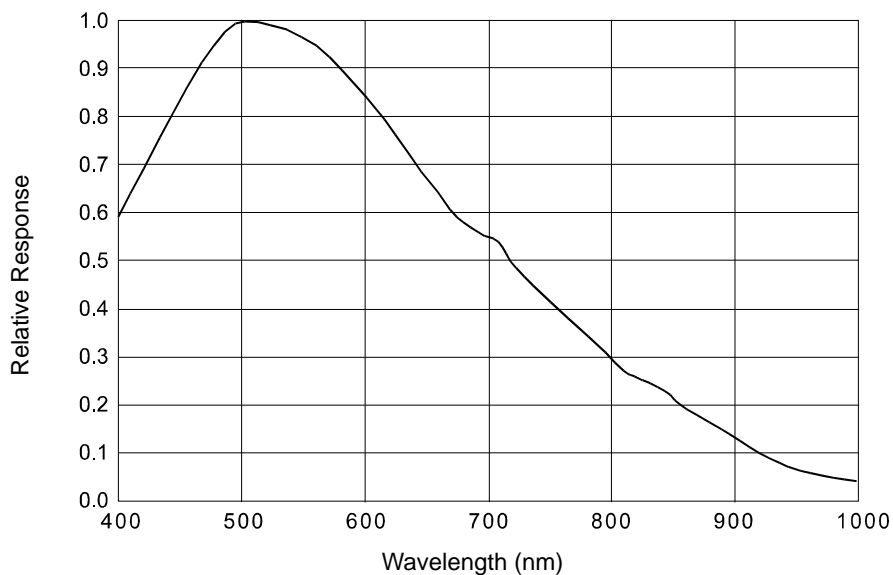

Fig. 1: acA640-90um Spectral Response (From Sensor Data Sheet)

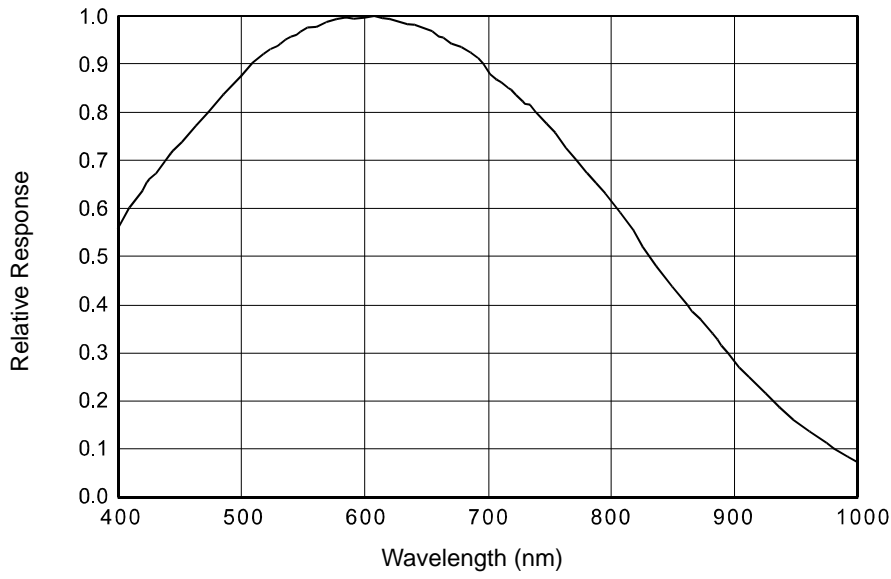

Fig. 2: acA640-120um Spectral Response (From Sensor Data Sheet)

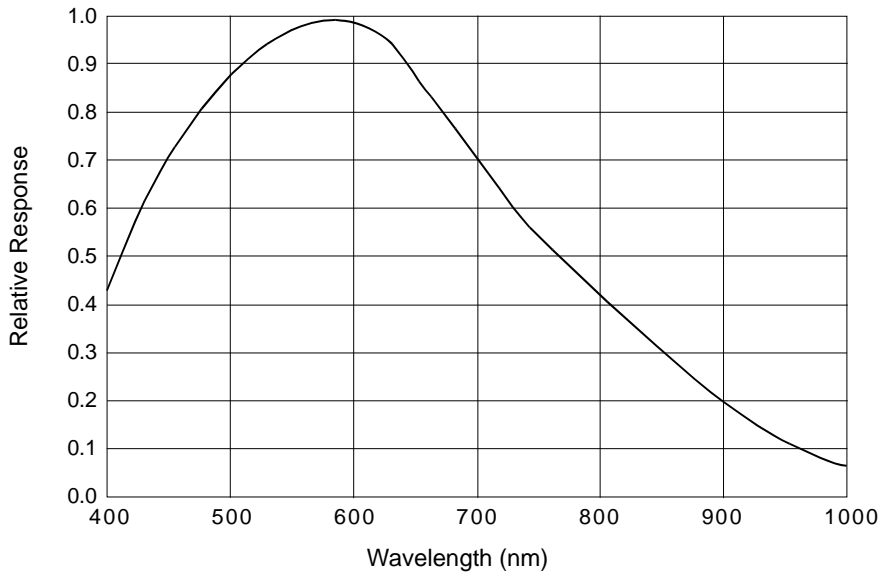

Fig. 3: acA1300-30um Spectral Response (From Sensor Data Sheet)

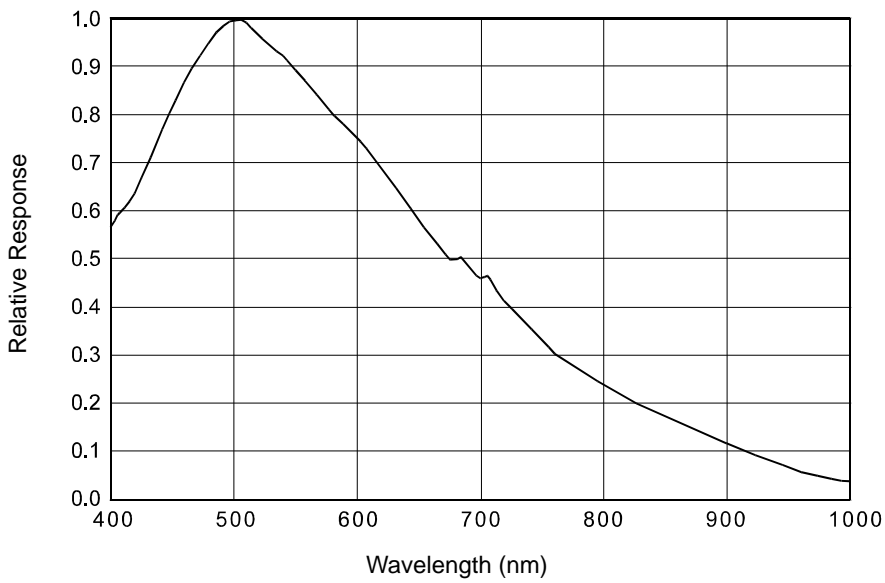

Fig. 4: acA1600-20um Spectral Response (From Sensor Data Sheet)

### 1.4.1.2 Cameras with CMOS Sensor

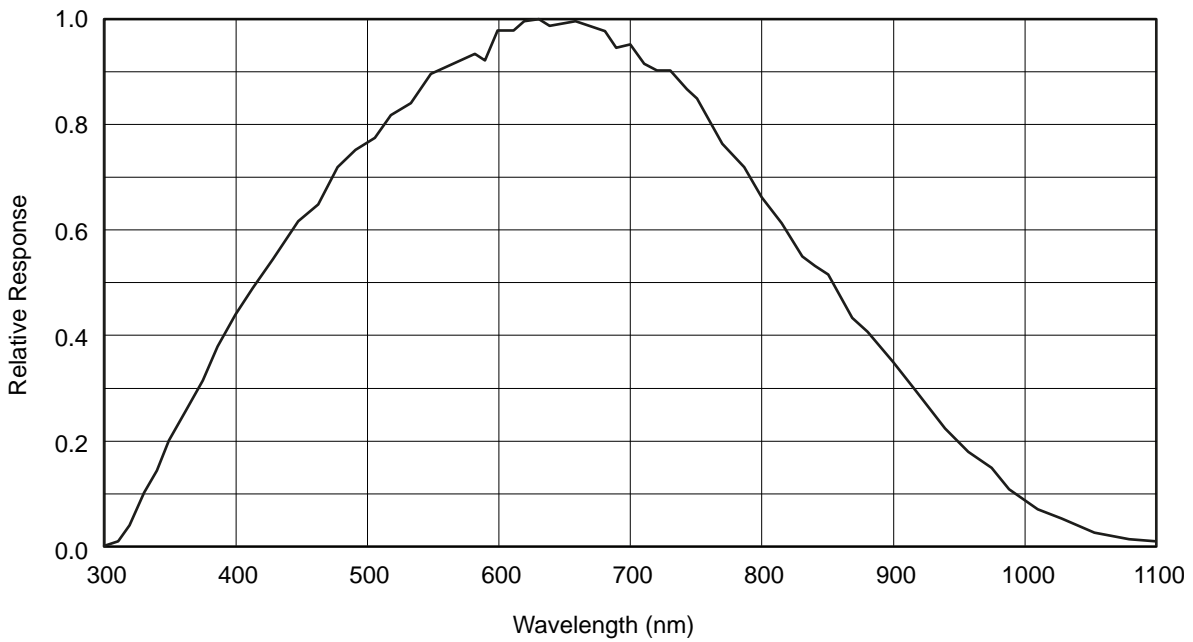

Fig. 5: acA640-750um, acA800-510um, acA1300-200um, acA1920-150um, and acA2500-60um, Spectral Response (From Sensor Data Sheet)

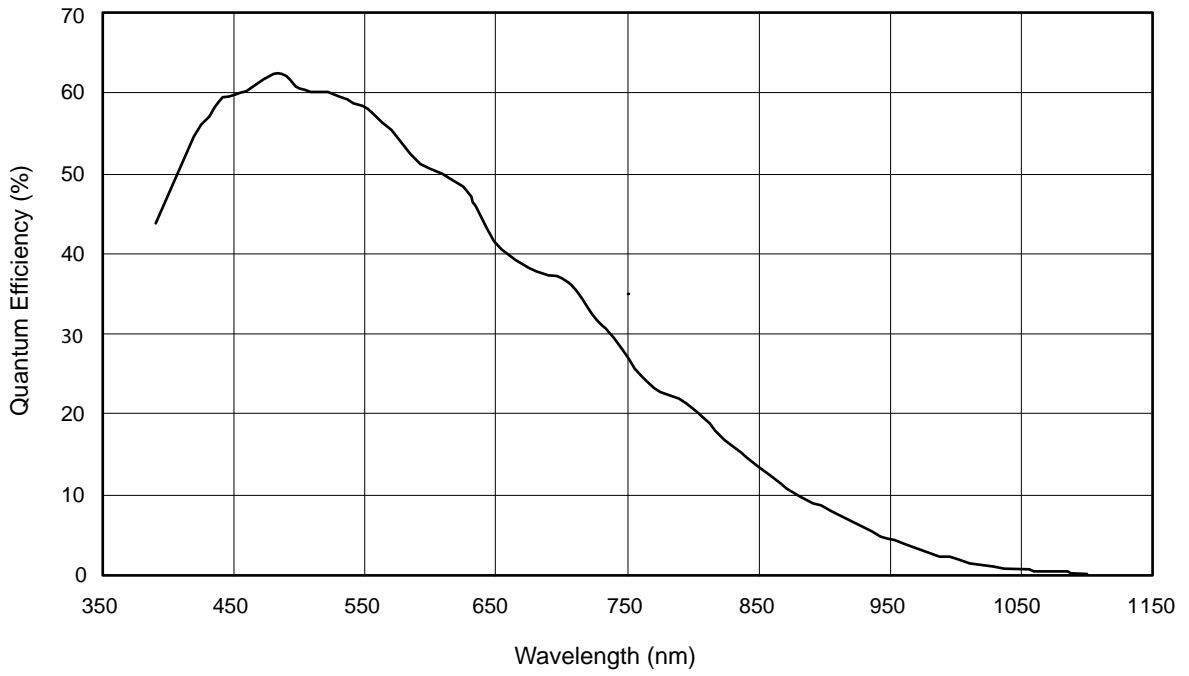

Fig. 6: acA1920-25um Spectral Response (From Sensor Data Sheet)

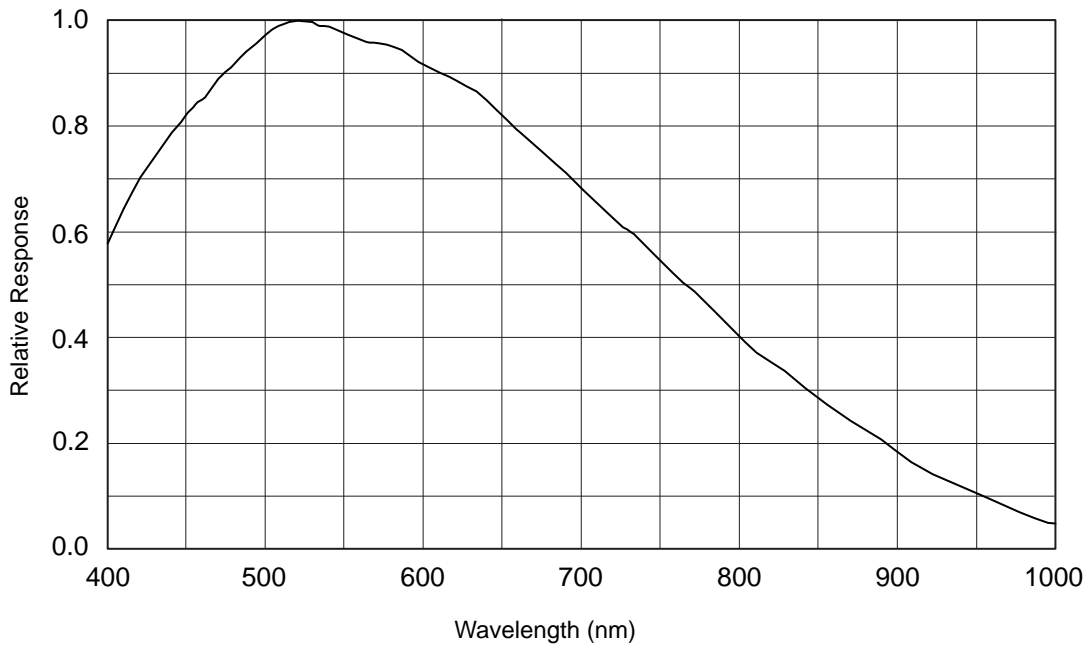

Fig. 7: acA1920-40um and acA1920-155um Spectral Response (From Sensor Data Sheet)

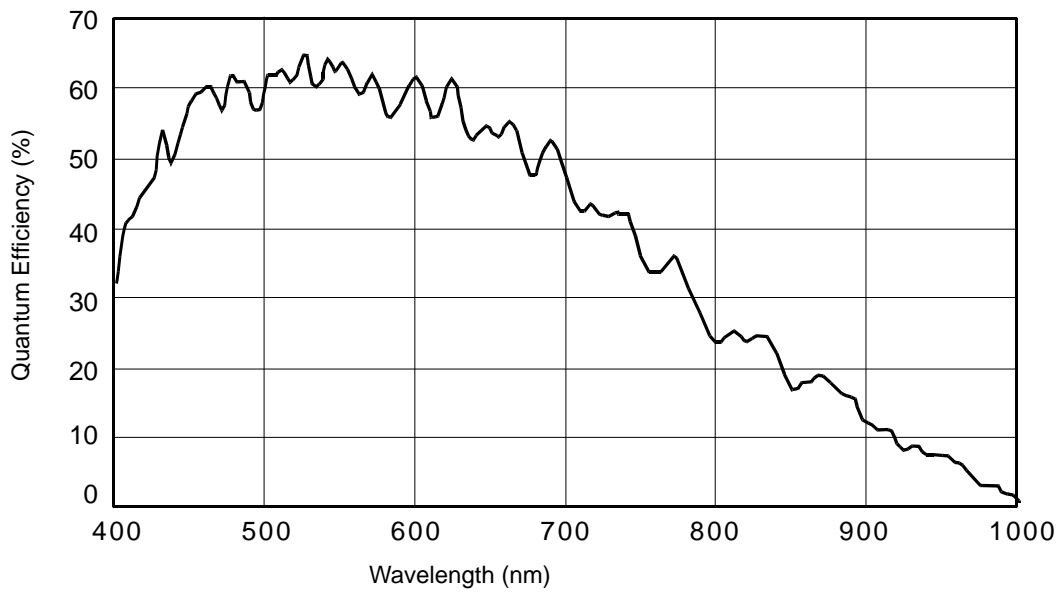

Fig. 8: acA2000-165um, acA2040-90um Spectral Response (From Sensor Data Sheet)

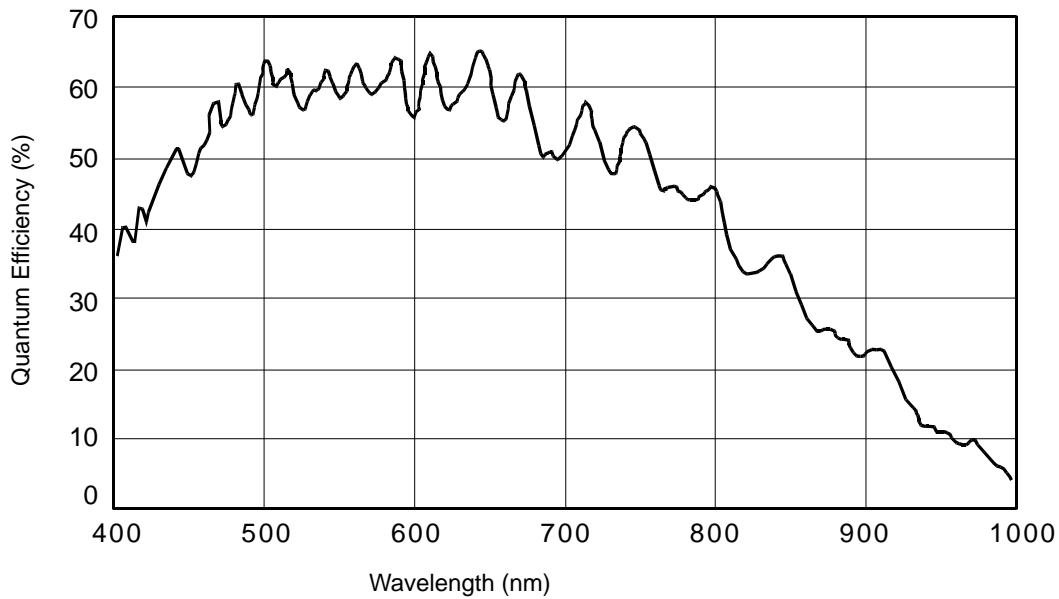

Fig. 9: acA2000-165umNIR, acA2040-90umNIR Spectral Response (From Sensor Data Sheet)



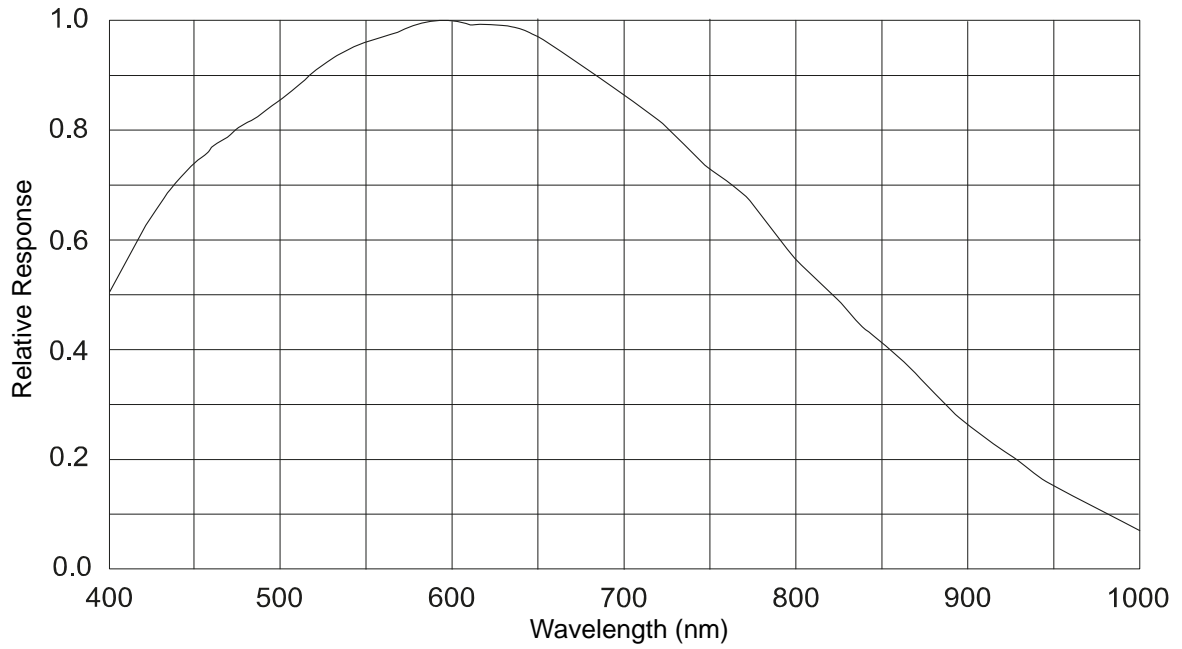

Fig. 10: acA2040-55um, acA2040-120um, acA2440-35um, and acA2440-75um (From Sensor Data Sheet)

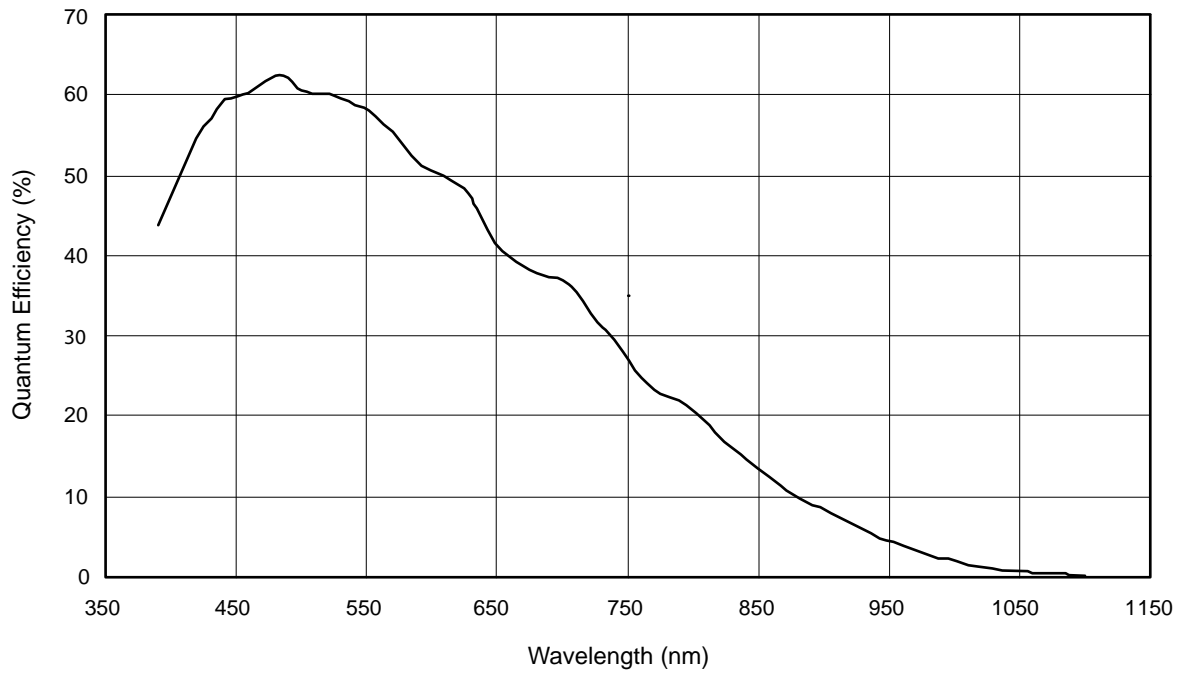

Fig. 11: acA2500-14um Spectral Response (From Sensor Data Sheet)

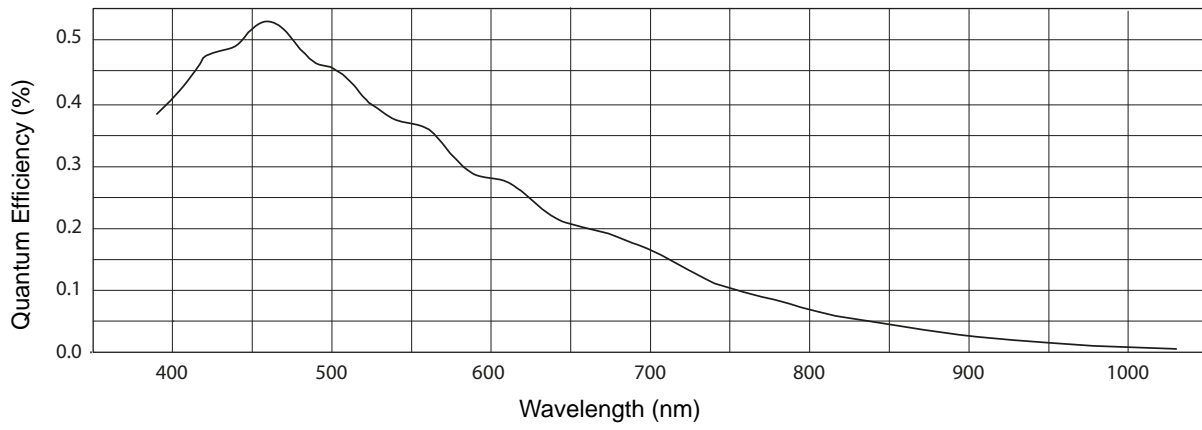



Fig. 12: acA3800-14um Spectral Response (From Sensor Data Sheet)

## 1.4.2 Color Camera Spectral Response

The following graphs show the spectral response for each available color camera model.

|   |   |
|---|---|
|  | <p>The spectral response curves exclude lens characteristics, light source characteristics, and IR-cut filter characteristics.</p> <p>To obtain best performance from color models of the camera, use of a dielectric IR cut filter is recommended. The filter should transmit in a range from 400 nm to 700 ... 720 nm, and it should cut off from 700 ... 720 nm to 1100 nm.</p> <p>A suitable IR cut filter is built into the cylindric housing extension in color models of the camera.</p> |
|---|---|

### 1.4.2.1 Cameras with CCD Sensor

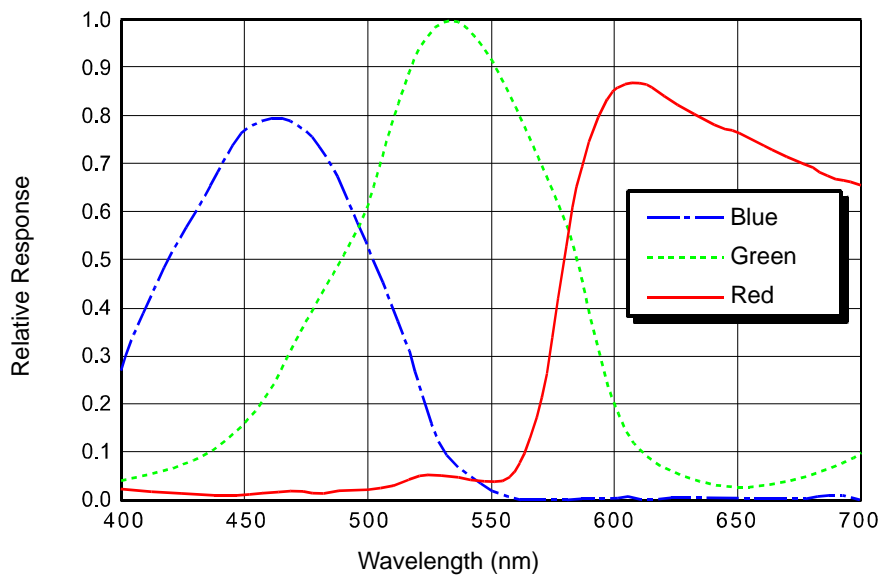

Fig. 13: acA640-90uc Spectral Response (From Sensor Data Sheet)

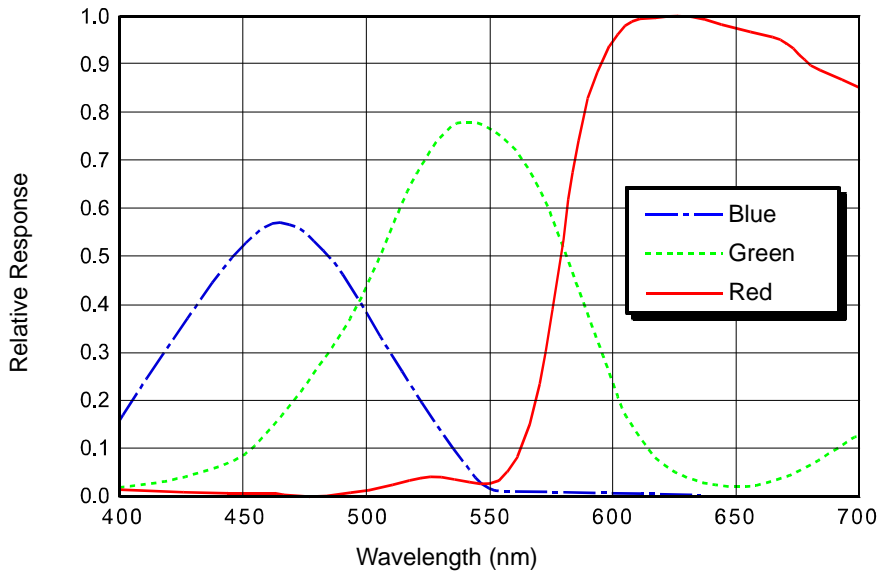

Fig. 14: acA640-120uc Spectral Response (From Sensor Data Sheet)

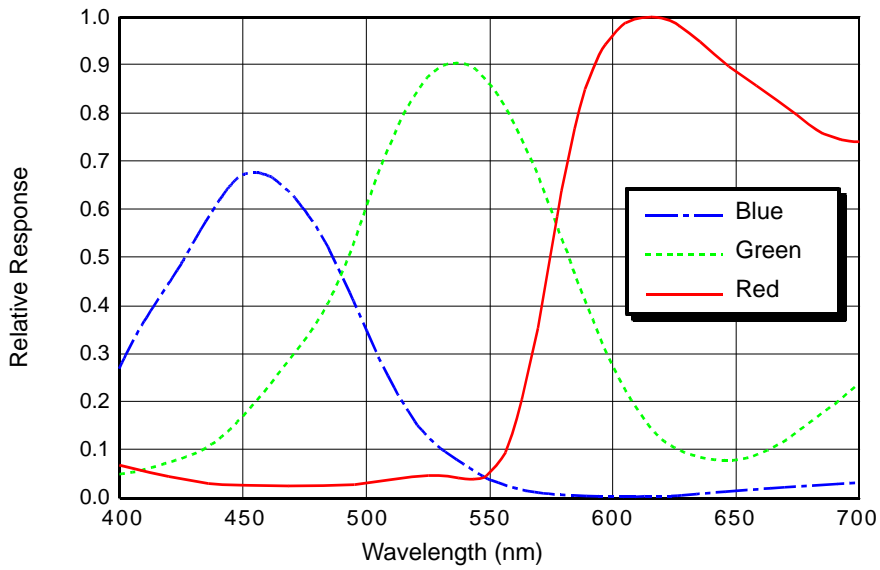

Fig. 15: acA1300-30uc Spectral Response (From Sensor Data Sheet)

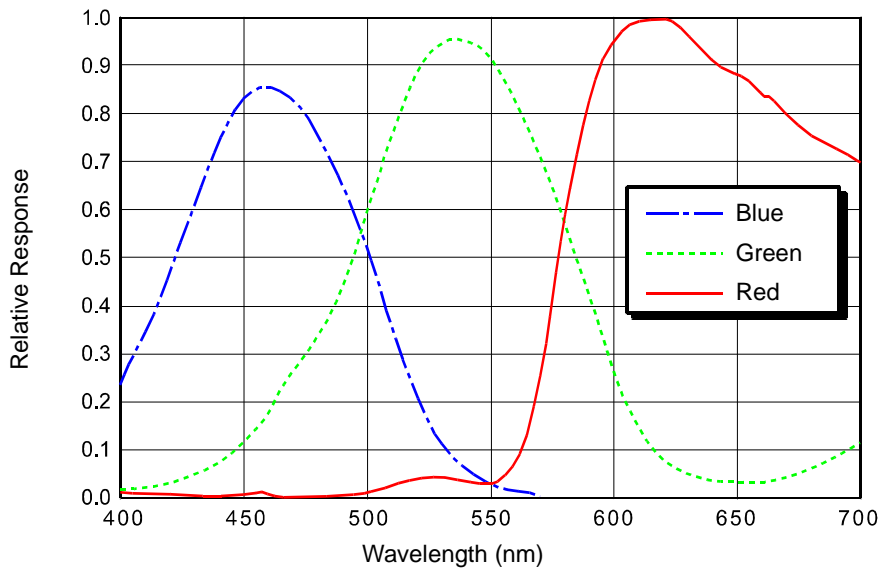

Fig. 16: acA1600-20uc Spectral Response (From Sensor Data Sheet)

### 1.4.2.2 Cameras with CMOS Sensor

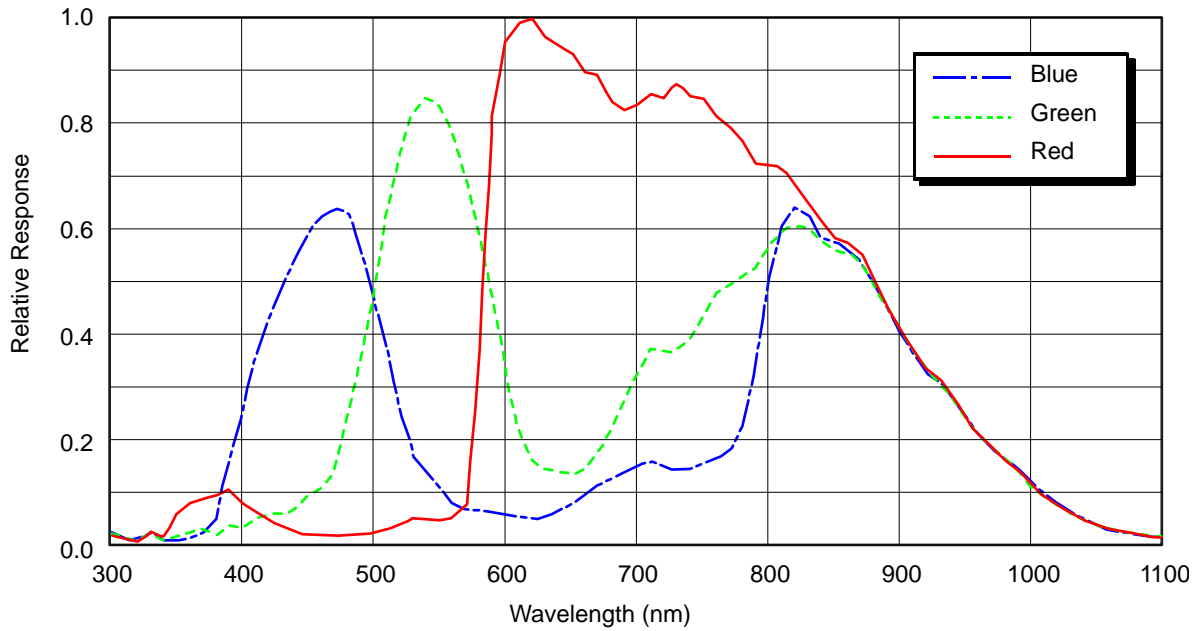

Fig. 17: acA640-750uc, acA800-510uc, acA1300-200uc, acA1920-150uc, and acA2500-60um, Spectral Response (From Sensor Data Sheet)

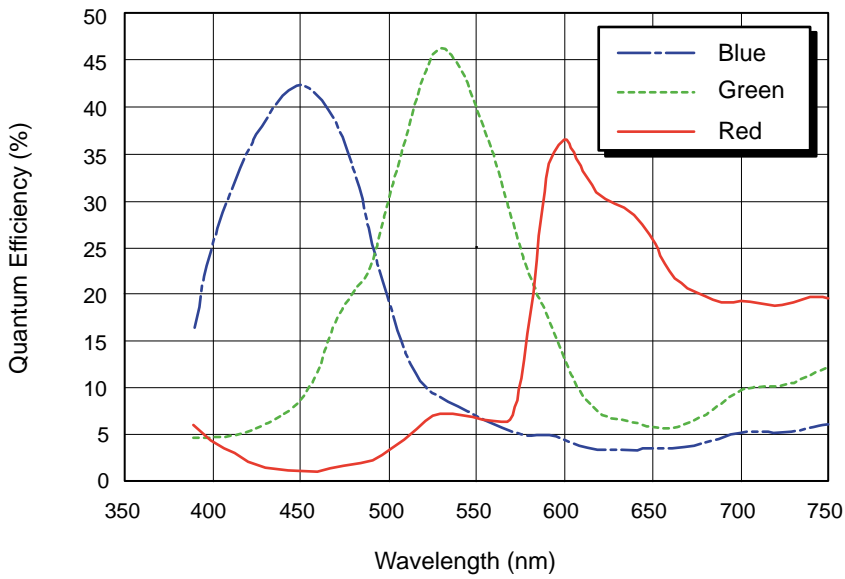

Fig. 18: acA1920-25uc Spectral Response (From Sensor Data Sheet)

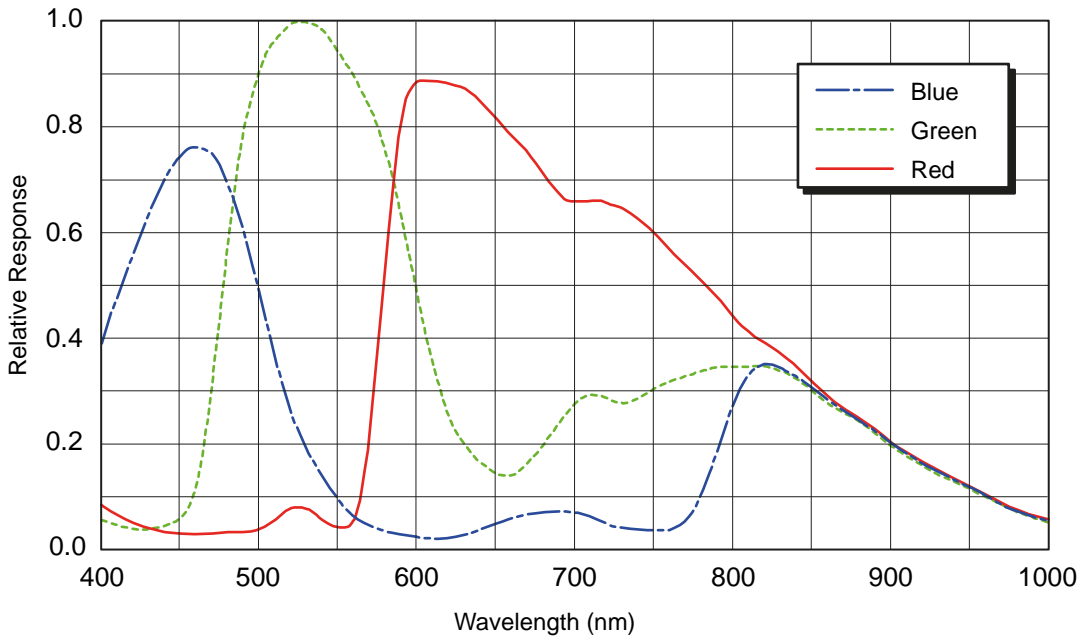

Fig. 19: acA1920-40uc and acA1920-155uc (From Sensor Data Sheet)

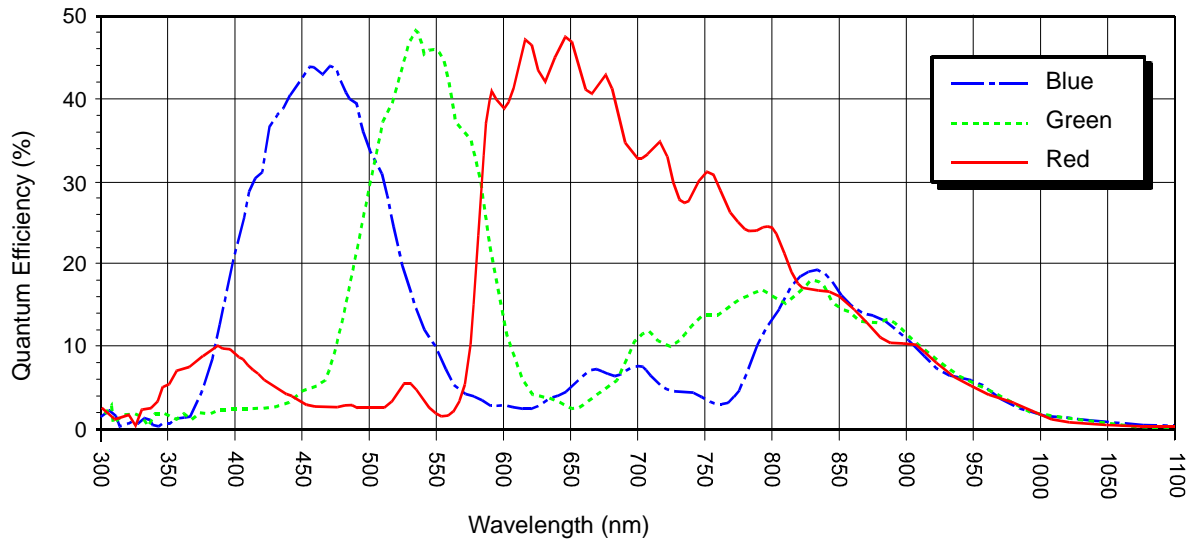

Fig. 20: acA2000-165uc, acA2040-90uc Spectral Response (From Sensor Data Sheet)

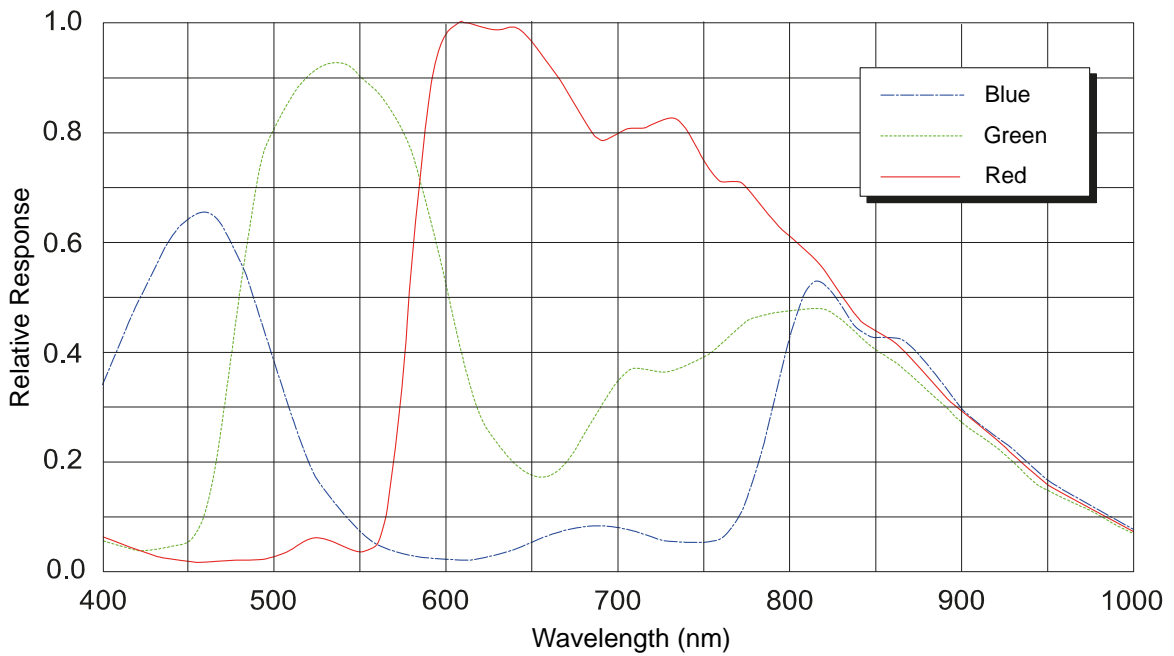

Fig. 21: acA2040-55uc, acA2040-120uc, acA2440-35uc, and acA2440-75uc (From Sensor Data Sheet)

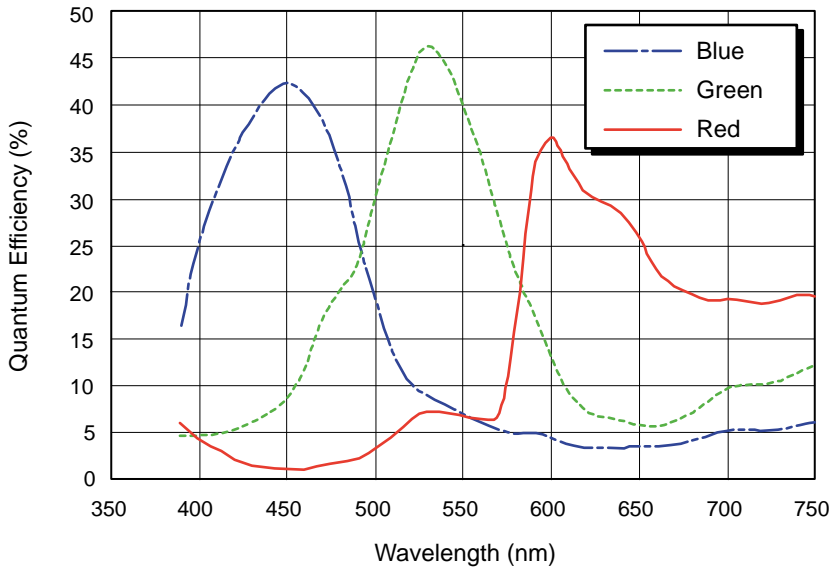

Fig. 22: acA2500-14uc Spectral Response (From Sensor Data Sheet)

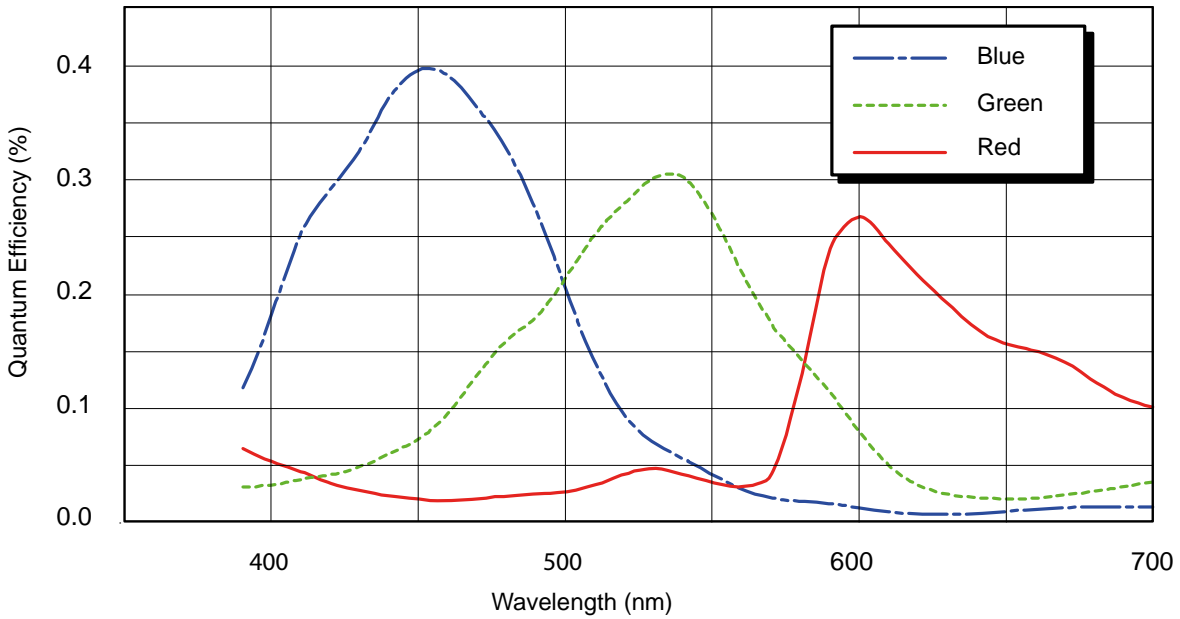

Fig. 23: acA3800-14uc Spectral Response (From Sensor Data Sheet)



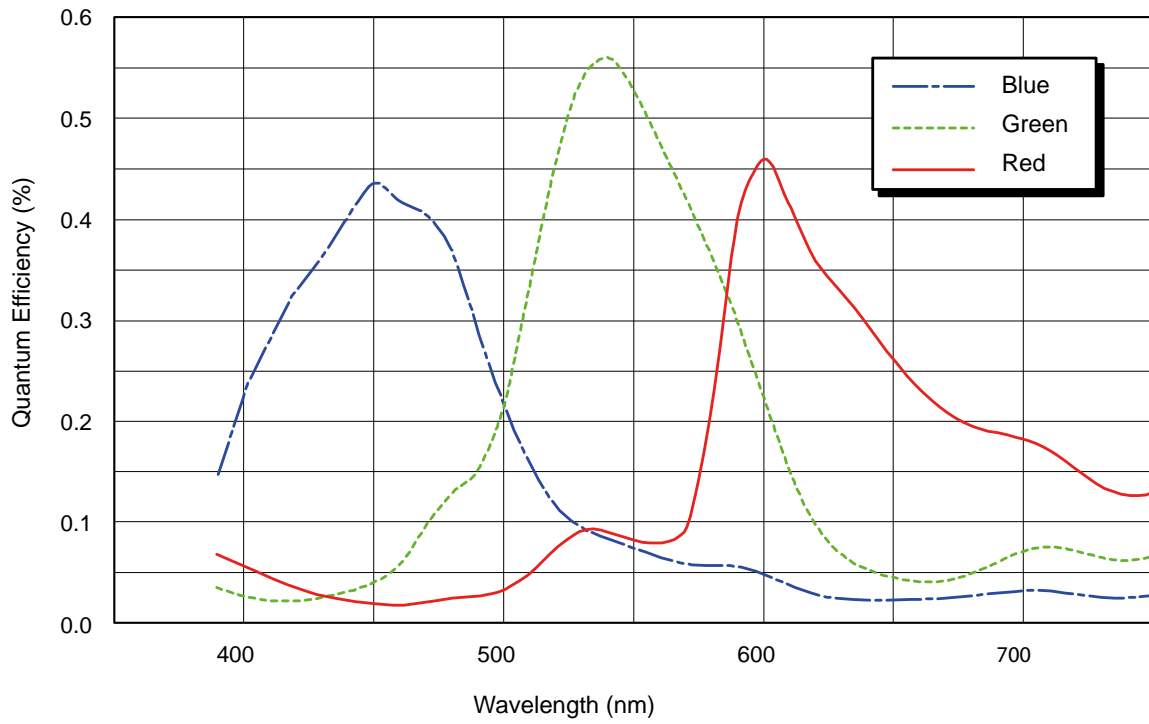

Fig. 24: acA4600-10uc Spectral Response (From Sensor Data Sheet)

## 1.5 Mechanical Specifications

The camera housing conforms to protection class IP30 assuming that the lens mount is covered by a lens or by the plastic cap that is shipped with the camera.

### 1.5.1 Camera Dimensions and Mounting Points

The dimensions in millimeters for cameras equipped with a C-mount are as shown in [Figure 25](#). The dimensions in millimeters for cameras equipped with a CS-mount are as shown in [Figure 26](#).

Note that some camera models are not available with CS-mount. For details, see Section 1.3.2 on [page 7](#).

Camera housings are equipped with mounting screw holes on the bottom as shown in the drawings. For mounting instructions, see Section 1.6 on [page 46](#).

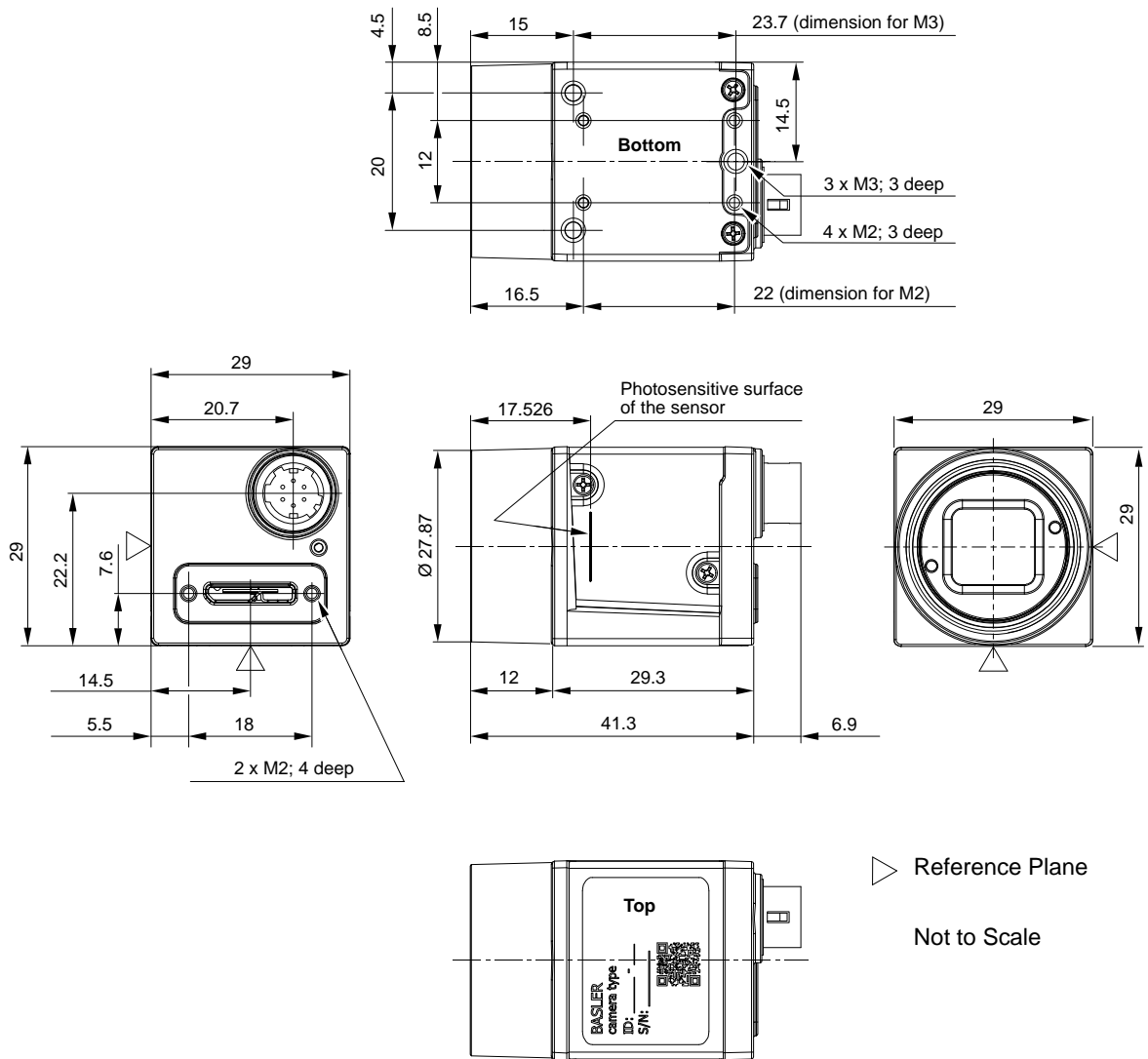

Fig. 25: Mechanical Dimensions (in mm) for Cameras with the C-mount

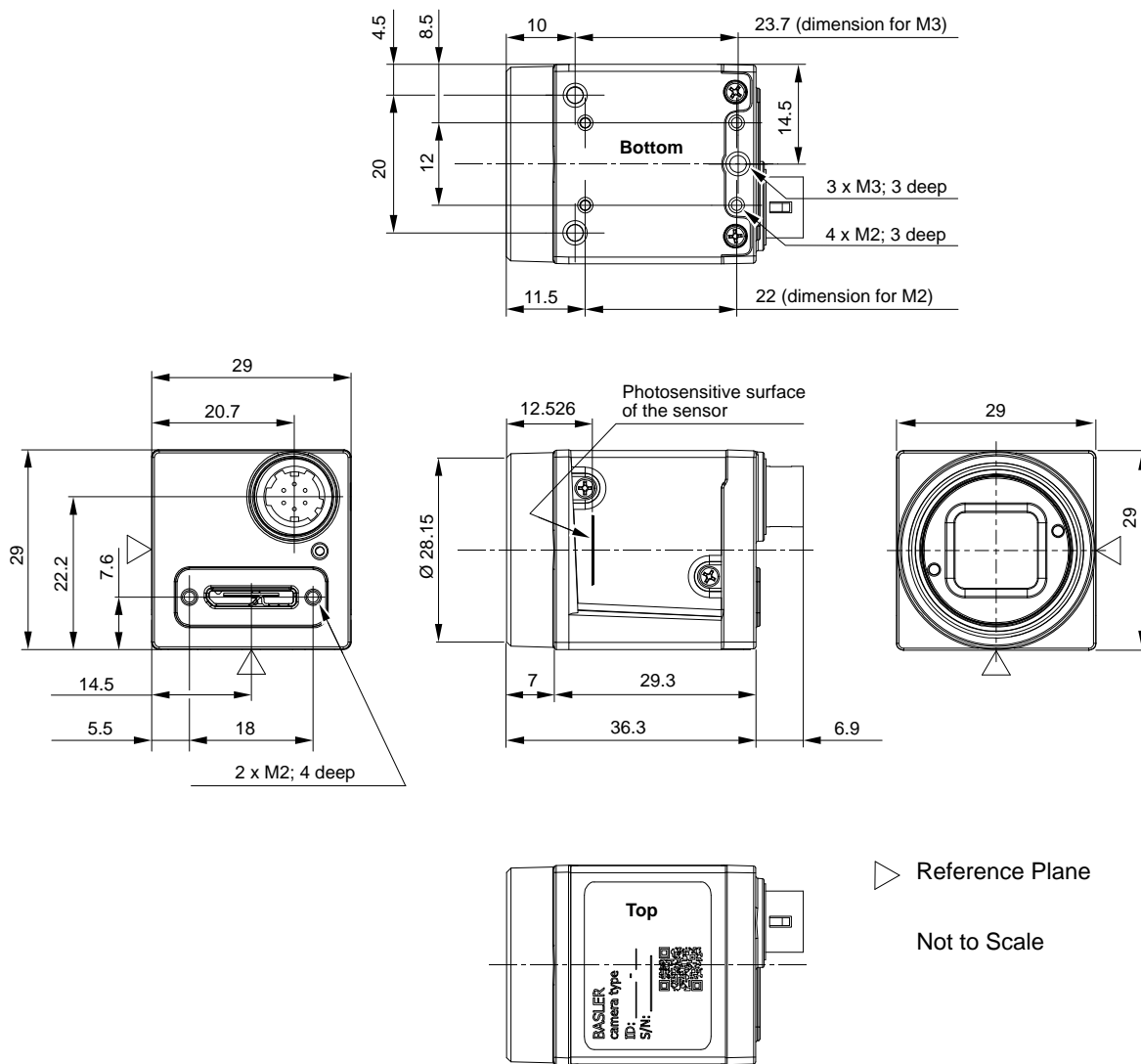

Fig. 26: Mechanical Dimensions (in mm) for Cameras with the CS-mount

## 1.5.2 Maximum Allowed Lens Thread Length

All cameras (mono and color) with C-mount and CS-mount are normally equipped with a plastic filter holder. The length of the threads on any lens you use with the cameras depends on the lens mount:

- Camera with C-mount (see [Figure 27](#)):  
The thread length can be a maximum of 9.6 mm, and the lens can intrude into the camera body a maximum of 10.8 mm.
- Camera with CS-mount (see [Figure 28](#)):  
The thread length can be a maximum of 4.6 mm, and the lens can intrude into the camera body a maximum of 5.8 mm.

### **NOTICE**

If either of the above limits is exceeded, the lens mount or the filter holder will be damaged or destroyed and the camera will no longer operate properly.

Note that on color cameras, the filter holder will be populated with an IR cut filter. On monochrome cameras, the filter holder will be present, but will not be populated with an IR cut filter.

You can obtain lenses with correct thread lengths from Basler (see [www.baslerweb.com](http://www.baslerweb.com)).

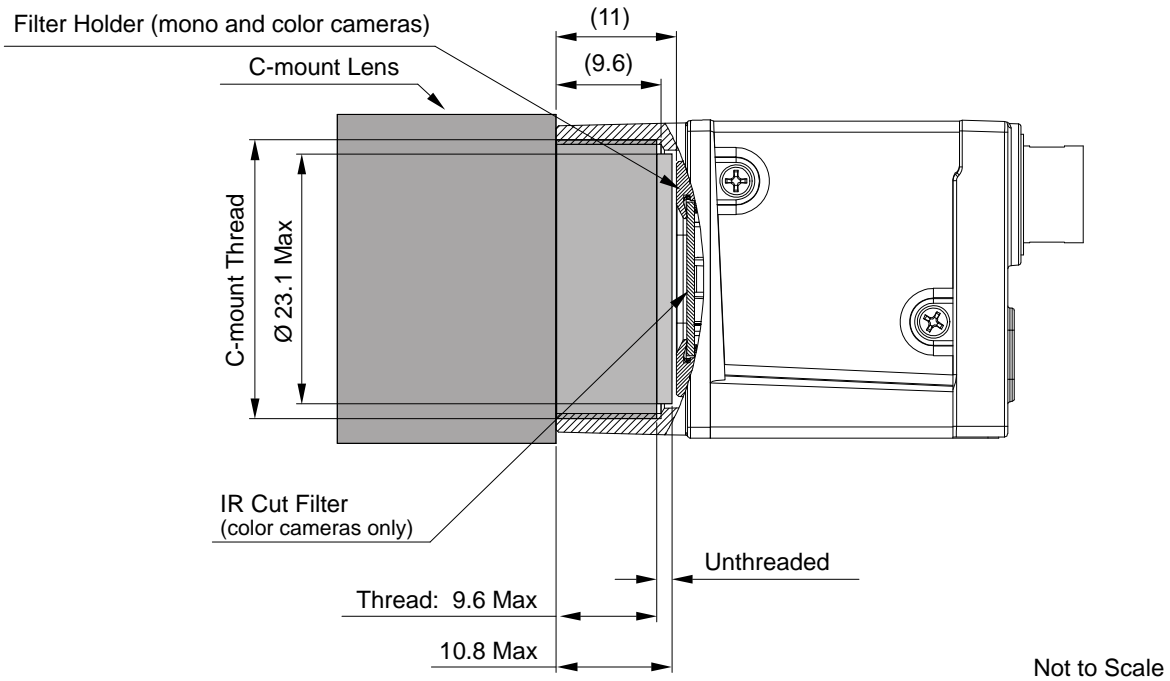

Fig. 27: Maximum Lens Thread Length (Dimensions in mm) for Cameras with the C-mount

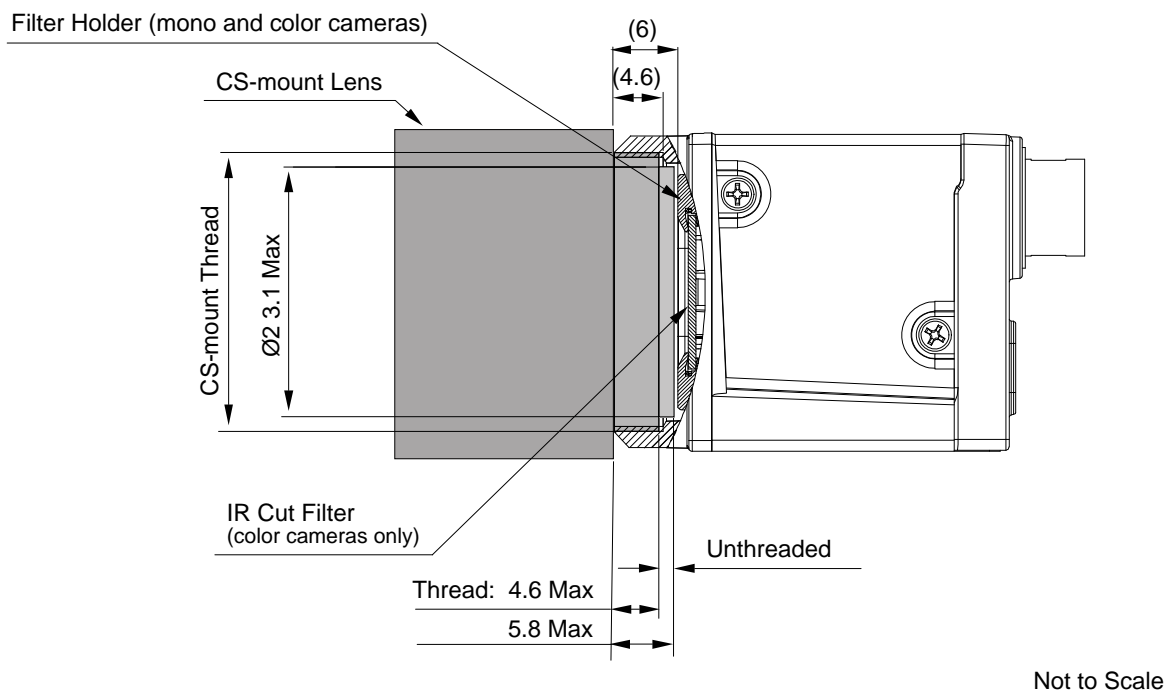

Fig. 28: Maximum Lens Thread Length (Dimensions in mm) for Cameras with the CS-mount

## 1.6 Mounting Instructions

To ensure optimum alignment of the camera when mounting the camera in your system, you must follow a certain tightening sequence when tightening screws.

Depending on whether you use M2 or M3 screws, a different tightening sequence applies.



The tightening sequences are illustrated in [Figure 29](#) and [Figure 30](#) for cameras with C-mounts. However, the tightening sequences apply equally to cameras with CS-mounts.

### 1.6.1 Tightening Sequence When Using the M2 Screws

#### To tighten the M2 screws:

1. Tighten the screws for the mounting screw holes (a) in [Figure 29](#).
2. Tighten the screws for the mounting screw holes (b) in [Figure 29](#).

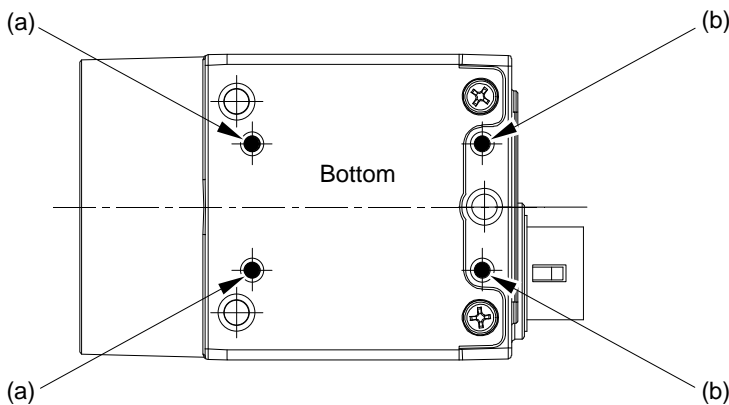

Fig. 29: Designations of the Mounting Screw Holes for the M2 Screws.

## 1.6.2 Tightening Sequence When Using the M3 Screws

### To tighten the M3 screws:

1. Tighten the screws for the mounting screw holes (a) in [Figure 30](#).
2. Tighten the screw for mounting screw hole (b) in [Figure 30](#).

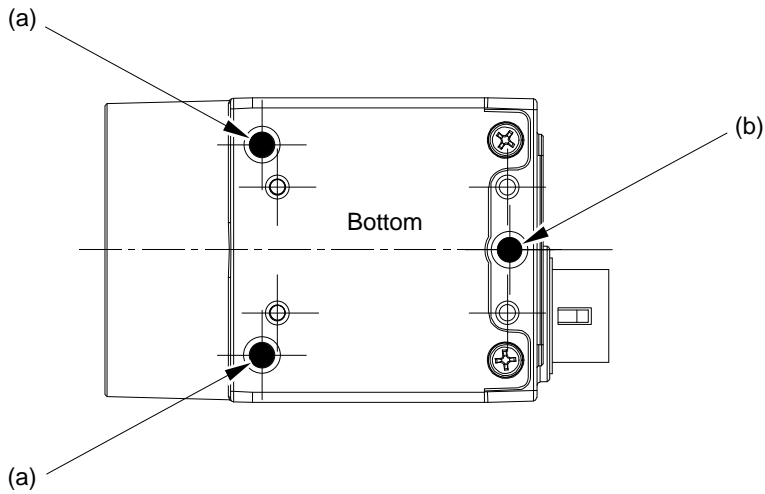

Fig. 30: Designations of the Mounting Screw Holes for the M3 Screws.



## 1.7 Mechanical Stress Test Results

Cameras were submitted to an independent mechanical testing laboratory and subjected to the stress tests listed below. The mechanical stress tests were performed on selected camera models. After mechanical testing, the cameras exhibited no detectable physical damage and produced normal images during standard operational testing.

| Test  | Standard          | Conditions   |
|---|-------------------|--|
| Vibration<br>(sinusoidal, each axis)                            | DIN EN 60068-2-6  | 10-58 Hz / 1.5 mm_58-500 Hz / 20 g_1 Octave/Minute<br>10 repetitions     |
| Shock (each axis)   | DIN EN 60068-2-27 | 20 g / 11 ms / 10 shocks positive<br>20 g / 11 ms / 10 shocks negative   |
| Bump (each axis)  | DIN EN 60068-2-29 | 20 g / 11 ms / 100 shocks positive<br>20 g / 11 ms / 100 shocks negative |
| Vibration<br>(broad-band random,<br>digital control, each axis) | DIN EN 60068-2-64 | 15-500 Hz / 0.05 PSD (ESS standard profile) / 00:30 h                    |

Table 19: Mechanical Stress Tests

The mechanical stress tests were performed with a dummy lens connected to a C-mount. The dummy lens was 35 mm long and had a mass of 66 g. Using a heavier or longer lens requires an additional support for the lens.

## 1.8 Software Licensing Information

The software in the camera includes the LZ4 implementation. The copyright information for this implementation is as follows:

LZ4 - Fast LZ compression algorithm

Copyright (C) 2011-2013, Yann Collet.

BSD 2-Clause License: (<http://www.opensource.org/licenses/bsd-license.php>)

Redistribution and use in source and binary forms, with or without modification, are permitted provided that the following conditions are met:

1. Redistributions of source code must retain the above copyright notice, this list of conditions and the following disclaimer.
2. Redistributions in binary form must reproduce the above copyright notice, this list of conditions and the following disclaimer in the documentation and/or other materials provided with the distribution.

THIS SOFTWARE IS PROVIDED BY THE COPYRIGHT HOLDERS AND CONTRIBUTORS "AS IS" AND ANY EXPRESS OR IMPLIED WARRANTIES, INCLUDING, BUT NOT LIMITED TO, THE IMPLIED WARRANTIES OF MERCHANTABILITY AND FITNESS FOR A PARTICULAR PURPOSE ARE DISCLAIMED. IN NO EVENT SHALL THE COPYRIGHT OWNER OR CONTRIBUTORS BE LIABLE FOR ANY DIRECT, INDIRECT, INCIDENTAL, SPECIAL, EXEMPLARY, OR CONSEQUENTIAL DAMAGES (INCLUDING, BUT NOT LIMITED TO, PROCUREMENT OF SUBSTITUTE GOODS OR SERVICES; LOSS OF USE, DATA, OR PROFITS; OR BUSINESS INTERRUPTION) HOWEVER CAUSED AND ON ANY THEORY OF LIABILITY, WHETHER IN CONTRACT, STRICT LIABILITY, OR TORT (INCLUDING NEGLIGENCE OR OTHERWISE) ARISING IN ANY WAY OUT OF THE USE OF THIS SOFTWARE, EVEN IF ADVISED OF THE POSSIBILITY OF SUCH DAMAGE.

## 1.9 Avoiding EMI and ESD Problems

The cameras are frequently installed in industrial environments. These environments often include devices that generate electromagnetic interference (EMI) and they are prone to electrostatic discharge (ESD). Excessive EMI and ESD can cause problems with your camera such as false triggering or can cause the camera to suddenly stop capturing images. EMI and ESD can also have a negative impact on the quality of the image data transmitted by the camera.

To avoid problems with EMI and ESD, you should follow these general guidelines:

- Always use high quality shielded cables. The use of high quality cables is one of the best defenses against EMI and ESD.
- Try to use camera cables that are only as long as necessary and try to run the camera cables and power cables parallel to each other. Avoid coiling camera cables. If the cables are too long, use a meandering path rather than coiling the cables.
- Avoid placing camera cables parallel to wires carrying high-current, switching voltages such as wires supplying stepper motors or electrical devices that employ switching technology. **Placing camera cables near to these types of devices can cause problems with the camera.**
- Attempt to connect all grounds to a single point, e.g., use a single power outlet for the entire system and connect all grounds to the single outlet. This will help to avoid large ground loops. (Large ground loops can be a primary cause of EMI problems.)
- Use a line filter on the main power supply.
- Install the camera and camera cables as far as possible from devices generating sparks. If necessary, use additional shielding.
- Decrease the risk of electrostatic discharge by taking the following measures:
  - Use conductive materials at the point of installation (e.g., floor, workplace).
  - Use suitable clothing (cotton) and shoes.
  - Control the humidity in your environment. Low humidity can cause ESD problems.



The Basler application note called Avoiding EMI and ESD in Basler Camera Installations provides much more detail about avoiding EMI and ESD. This application note can be obtained from the Downloads section of our website: [www.baslerweb.com](http://www.baslerweb.com)

# 1.10 Environmental Requirements

## 1.10.1 Temperature and Humidity

Housing temperature during operation: 0 °C ... +50 °C (+32 °F ... +122 °F)

Housing temperature during operation  
for acA2000-165 and acA2040-90 only: 0 °C ... +60 °C (+32 °F ... +140 °F)

Housing temperature according to UL 60950-1: max. 70 °C (+158 °F)

Ambient temperature according to UL 60950-1: max. 30 °C (+86 °F)

**UL 60950-1 test conditions:** no lens attached to the camera and without efficient heat dissipation; ambient temperature kept at 30 °C (+86 °F).

Humidity during operation: 20 % ... 80 %, relative, non-condensing

Storage temperature: -20 °C ... +80 °C (-4 °F ... +176 °F)

Storage humidity: 20 % ... 80 %, relative, non-condensing

### Temperature Measuring Spot

You must determine the camera housing temperature on a specific measuring spot. Its location on the camera housing is indicated in the figure below.

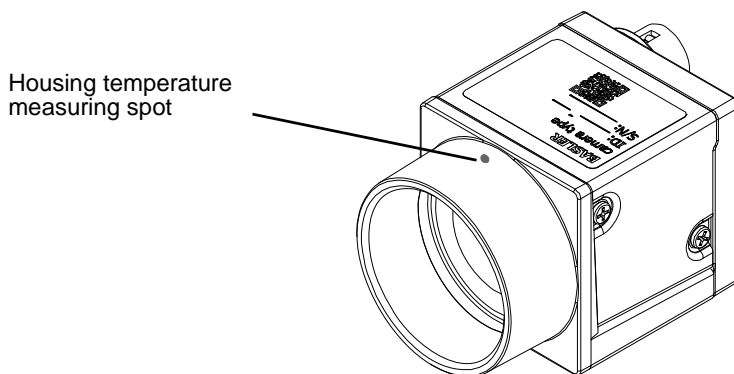

Fig. 31: Location of the Housing Temperature Measuring Spot on the Camera Housing

## 1.10.2 Heat Dissipation

You must provide sufficient heat dissipation to maintain the camera housing temperature at the maximum value or below as specified for the camera during operation (see above). Since each installation is unique, we only provide the following general guidelines:

- Make sure a lens is mounted on the camera.
- In all cases, you should monitor the temperature of the camera housing and ensure that the temperature does not exceed the maximum specified value for the housing temperature during operation. Keep in mind that the camera will gradually become warmer during the first hour of operation. After one hour, the housing temperature should stabilize and no longer increase.
- Provide sufficient heat dissipation by e.g. mounting the camera on a substantial, thermally conductive component that can act as a heat sink and by using a fan to provide an air flow over the camera.



To ensure good image quality, we recommend not to operate the camera at elevated temperatures.

## 1.10.3 Over Temperature Behavior

The following camera models include a certain over temperature behavior: acA640-750u, acA800-510u, acA1300-200u, acA1920-40u, acA1920-150u, acA1920-155u, acA2040-55u, acA2040-120u, acA2500-60u, acA2440-35u, and acA2440-75u.

At elevated temperature, the camera can be damaged. To decrease risk of overheating, and to allow timely action for improved heat dissipation, the following mechanisms are implemented:

- When a temperature is reached where damage is imminent, the camera enters the over temperature mode. In this mode, the camera is powered down to prevent damage to the camera due to overheating. The camera no longer acquires images but delivers the internally generated test image 2 (see Section 7.18.1 on [page 324](#)).
- Events can be sent to notify that the camera's device temperature has reached a critical level (Critical Temperature event) or, upon further heating, that the camera has entered the over temperature mode (Over Temperature event).
- You can read the TemperatureState parameter value to see whether the camera is close to overheating or is already in over temperature mode. For information about reading the parameter value, see Section 1.10.3.1 on [page 55](#).

The mechanisms are based on the device temperature. It is measured inside the camera and reported in intervals of 1 °C. Currently, only the core board temperature can be selected as the device temperature.

You can monitor the internal temperature by reading the DeviceTemperature parameter value (see Section 1.10.3.1 on [page 55](#)).

The mechanisms are activated at different internal temperatures, depending on whether the camera follows a heating or cooling path. The mechanisms are illustrated for both paths in [Figure 32](#) and are described in detail below.



The following explanations assume that event notification is enabled.

To be able to receive events, make sure event notification is enabled and some additional software-related settings are made (see Section 7.17 on [page 319](#)).

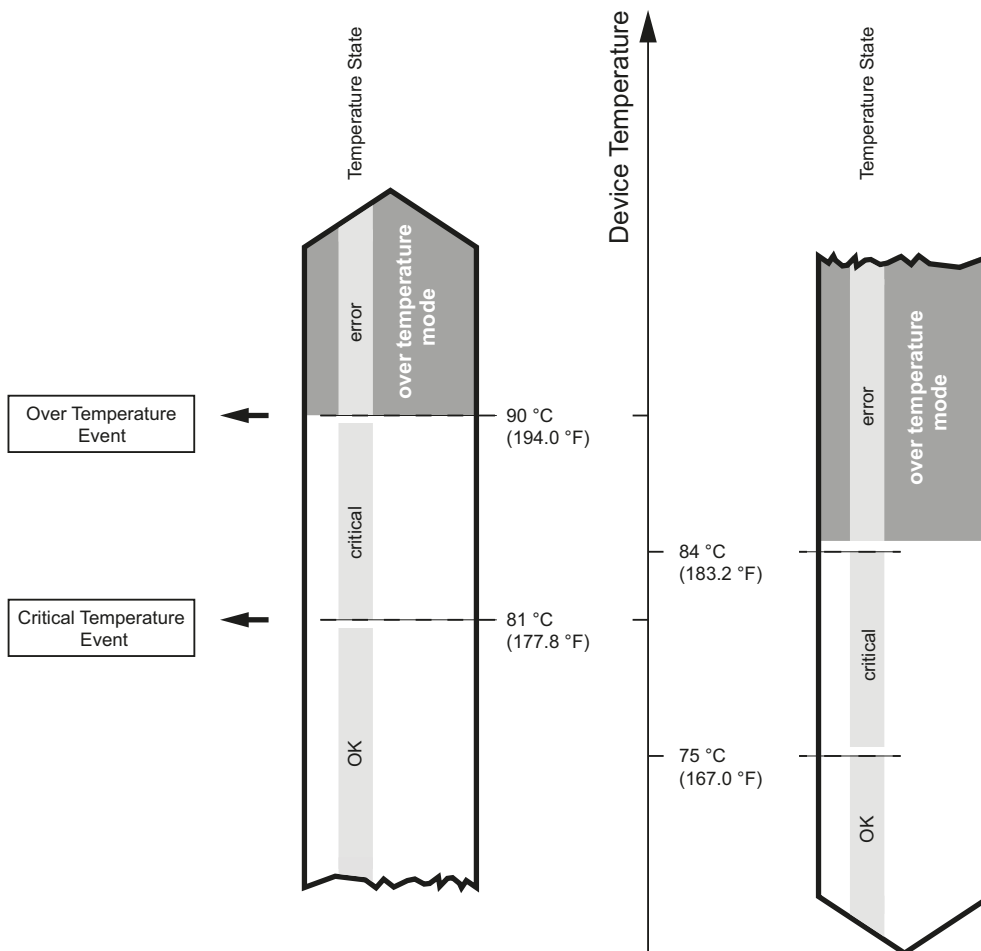



Fig. 32: Over Temperature Behavior and Related Mechanisms According to Heating and Cooling Paths.

### Heating Path

- When the device temperature reaches 81 °C (177.8 °F) the following occurs:
  - The TemperatureState parameter value changes from OK to Critical.
  - A Critical Temperature event is sent (see Section 7.17 on [page 319](#)). Note that the next Critical Temperature event can only be sent after the device temperature has fallen to at least 75 °C (167.0 °F).

- When the device temperature reaches 90 °C (194.0 °F), the following occurs:
  - The camera enters the over temperature mode.
  - The TemperatureState parameter value changes from Critical to Error
  - An Over Temperature event is sent (see Section 7.17 on [page 319](#)). Note that the next Over Temperature event can only be sent after the device temperature has fallen to at least 84 °C (183.2 °F).

|   |  |
|---|--|
|  | <p>When the camera enters the over temperature mode, take prompt action to cool the camera. Otherwise, irreversible damage to the camera can occur.</p> <p>The camera's powering down is meant to protect the camera by allowing it to cool. However, if the environmental temperature is sufficiently high, the camera's internal temperature will nonetheless stay high or increase even further.</p> <ul style="list-style-type: none"> <li>■ Provide sufficient heat dissipation (see Section 1.10.2 on <a href="#">page 52</a>) to quickly decrease the camera's internal temperature and exit the over temperature mode.</li> <li>■ Provide sufficient heat dissipation to ensure that the camera will ideally never return to the over temperature mode.</li> </ul> |
|---|--|

### Cooling Path

- When the camera cools from a temperature where the over temperature mode is active to a device temperature of 84 °C (183.2 °F), the following occurs:
  - The camera leaves the over temperature mode and returns to normal operation. Thereby, the same camera settings are used as before when the camera changed to over temperature mode.
  - The TemperatureState parameter value changes from Error to Critical.
- When cooling continues and the device temperature reaches 75 °C (+167.0 °F), the following occurs:
  - The TemperatureState parameter value changes from Critical to OK.

|   |  |
|---|--|
|  | <ul style="list-style-type: none"> <li>■ Note that normal operation of the camera requires that           <ul style="list-style-type: none"> <li>■ the camera's device temperature is below 75 °C (+167.0 °F)</li> <li><b>and that</b></li> <li>■ the housing temperature stays within the specified range of the "housing temperature during operation" (see Section 1.10.1 on <a href="#">page 51</a>).</li> </ul> </li> <li>■ Note that elevated temperatures worsen image quality and shorten the camera's lifetime. The lifetime is also shortened with increasing number of high-temperature incidents.</li> </ul> |
|---|--|

### 1.10.3.1 Monitoring the Internal Temperature

You can monitor the internal temperature by reading the DeviceTemperature parameter value [°C] and the TemperatureState parameter value.

- To read the DeviceTemperature parameter value, you must select an internal temperature as the device temperature. Currently, only the core board temperature can be selected as the device temperature.
- The parameter values for the TemperatureState parameter can be Normal, Critical, and Error. For information about their meanings, see [Figure 32](#) and the related descriptions.

The following code snippet illustrates using the API to select the core board temperature as the device temperature, read the current device temperature, and get informed about the current temperature state:



```
// Select the kind of internal temperature as the device temperature
camera.DeviceTemperatureSelector.SetValue(DeviceTemperatureSelector_C
oreboard);
// Determine the kind of internal temperature that was selected
// as the device temperature
DeviceTemperatureSelectorEnums e =
camera.DeviceTemperatureSelector.GetValue();
// Read the device temperature
double d = camera.DeviceTemperature.GetValue();
// Determine the current temperature state
TemperatureStateEnums e = camera.TemperatureState.GetValue();
```



You can also use the Basler pylon Viewer application to easily read the parameter.

For more information about the pylon API and the pylon Viewer, see [Section 3.1 on page 62](#).



## 1.11 Precautions

|  <b>DANGER</b> |  |
|---|--|
|                | <p><b>Electric Shock Hazard</b></p> <p>Risk of Burn or Death.</p> <p>The power supplies used for supplying</p> <ul style="list-style-type: none"><li>■ power to the I/O lines and</li><li>■ camera power</li></ul> <p>must meet the Safety Extra Low Voltage (SELV) and Limited Power Source (LPS) requirements.</p> <p>If you use a powered hub as part of the USB 3.0 connection, the powered hub must meet the SELV and LPS requirements.</p> |

|  <b>WARNING</b> |   |
|--|---|
|                | <p><b>Fire Hazard</b></p> <p>Risk of Burn</p> <p>The power supplies used for supplying</p> <ul style="list-style-type: none"><li>■ power to the I/O lines and</li><li>■ camera power</li></ul> <p>must meet the Limited Power Source (LPS) requirements.</p> <p>If you use a powered hub as part of the USB 3.0 connection, the powered hub must meet the LPS requirements.</p> |

| <b>NOTICE</b>  |  |
|--|--|
| <p>Voltage outside of the specified range can cause damage.</p> <ul style="list-style-type: none"><li>■ You must supply camera power that complies with the Universal Serial Bus 3.0 specification. The camera's nominal operating voltage is +5 VDC, effective on the camera's connector.</li></ul> |  |

**NOTICE**

Constant operating conditions for acA1920-150um/uc and acA2500-60um/uc cameras.

The cameras require constant ambient temperature and are designed for continuous operation only.

Make sure the cameras are constantly powered up: Interrupt the connection or switch of the connected computer only when required for installation or maintenance.

If you do not observe these instructions, the lifetime of the camera will be reduced significantly.

**NOTICE**

Avoid dust on the sensor.

The camera is shipped with a protective plastic cap on the lens mount. To avoid collecting dust on the camera's IR cut filter (color cameras) or sensor (mono cameras), make sure that you always put the plastic cap in place when there is no lens mounted on the camera.

To avoid collecting dust on the camera's IR cut filter (color cameras) or sensor (mono cameras), make sure to observe the following:

- Always put the plastic cap in place when there is no lens mounted on the camera.
- Make sure that the camera is pointing down every time you remove or replace the plastic cap or a lens.
- Never apply compressed air to the camera. This can easily contaminate optical components, particularly the sensor.

**NOTICE**

On all cameras, the lens thread length is limited.

All cameras (mono and color) are equipped with a plastic filter holder located in the cylindrical housing extension. The location of the filter holder limits the length of the threads on any lens you use with the camera. If a lens with a very long thread length is used, the filter holder or the lens mount will be damaged or destroyed and the camera will no longer operate properly.

For more specific information about the lens thread length, see Section 1.5.2 on [page 44](#).

**NOTICE**

Using a wrong pin assignment can severely damage the camera:

- Make sure the cable and plug you connect to the 6-pin I/O connector follow the correct pin assignment.

**NOTICE**

An incorrect plug can damage the 6-pin connector:

- The plug on the cable that you attach to the camera's 6-pin I/O connector must have 6 female pins. Using a plug designed for a smaller or a larger number of pins can damage the connector.
- The plug on the cable that you attach to the camera's USB 3.0 Micro-B port must be designed for use with the USB 3.0 Micro-B port. Trying to use any other type of plug can destroy the port.

## Warranty Precautions

**To ensure that your warranty remains in force:**

### Do not remove the camera's serial number label

If the label is removed and the serial number can't be read from the camera's registers, the warranty is void.

### Do not open the camera housing

Do not open the housing. Touching internal components may damage them.

### Keep foreign matter outside of the camera

Be careful not to allow liquid, flammable, or metallic material inside of the camera housing. If operated with any foreign matter inside, the camera may fail or cause a fire. For the special case of cleaning the camera's sensor, see the instructions below.

### Avoid electromagnetic fields

Do not operate the camera in the vicinity of strong electromagnetic fields. Avoid electrostatic charging.

### Transport properly

Transport the camera in its original packaging only. Do not discard the packaging.

### Clean properly

#### Note:

- Before starting the cleaning procedure, cut off all power to the camera by unplugging the plugs from the USB 3.0 Micro-B port and from the 6-pin I/O connector.
- Make sure all window cleaner or detergent has vaporized after the cleaning procedure, before reconnecting the plugs.

Avoid cleaning the surface of the camera's sensor, if possible. If you must clean it, use a soft, lint free cloth dampened with a small quantity of high quality window cleaner. Because electrostatic discharge can damage the sensor, you must use a cloth that will not generate static during cleaning (cotton is a good choice).

To clean the surface of the camera housing, use a soft, dry cloth. To remove severe stains, use a soft cloth dampened with a small quantity of neutral detergent, then wipe dry.

Do not use solvents or thinners to clean the housing; they can damage the surface finish.

### Ensure Continuous Operation

Operate acA1920-150um/uc and acA2500-60um/uc cameras continuously under constant ambient temperature.

### Read the manual



Read the manual carefully before using the camera!



## 2 Installation

The information needed for installing the camera and related software is included in the *Installation and Setup Guide for Cameras Used With pylon for Windows* (AW000611).

You can download the document from the Basler website: [www.baslerweb.com](http://www.baslerweb.com)

Drivers and Tools for changing camera parameters are indicated in the next chapter.

|   |   |
|---|---|
|  |  <b>DANGER</b>   |
|   | <p><b>Electric Shock Hazard</b></p> <p>Risk of Burn or Death.</p> <p>The power supplies used for supplying</p> <ul style="list-style-type: none"> <li>■ power to the I/O lines and</li> <li>■ camera power</li> </ul> <p>must meet the Safety Extra Low Voltage (SELV) and Limited Power Source (LPS) requirements.</p> <p>If you use a powered hub as part of the USB 3.0 connection, the powered hub must meet the SELV and LPS requirements.</p> |

|   |  |
|---|--|
|  |  <b>WARNING</b>   |
|   | <p><b>Fire Hazard</b></p> <p>Risk of Burn</p> <p>The power supplies used for supplying</p> <ul style="list-style-type: none"> <li>■ power to the I/O lines and</li> <li>■ camera power</li> </ul> <p>must meet the Limited Power Source (LPS) requirements.</p> <p>If you use a powered hub as part of the USB 3.0 connection, the powered hub must meet the LPS requirements.</p> |

|   |  |
|---|--|
|  | <p>The camera is designed to be connected to a USB 3.0 port installed in your computer. When connected to a USB 2.0 port, the Basler ace USB 3.0 camera will be detected but will not operate.</p> |
|---|--|



Note: We highly recommend using components such as host adapters with specific chipsets, cables, and hubs that are offered as Basler accessories. They were extensively tested for optimum performance.

For more information about accessories available from Basler and about purchasing, go to the Basler website: [www.baslerweb.com](http://www.baslerweb.com)



Default factory parameter settings for acA2000-165u and acA2040-90u cameras will initially prevent them from operating at their maximum specified frame rates. This provision was made to avoid problems that might result from insufficient available USB 3.0 bandwidth made available by your application.

The following initial factory-set maximum frame rates apply:

- acA2000-165u: approximately 90 fps
- acA2040-90u: approximately 50 fps.

You can easily increase the camera parameter settings and operate the cameras at the maximum specified frame rates if sufficient USB 3.0 bandwidth is available.

# 3 Tools for Changing Camera Parameters

## 3.1 Basler pylon Camera Software Suite

The Basler pylon Camera Software Suite is designed to operate all Basler cameras that have an IEEE 1394a/b interface, a GigE interface or a USB 3.0 interface. The Basler pylon Camera Software Suite will also operate newer Basler camera models with a Camera Link interface.

The pylon camera drivers offer reliable, real-time image data transport into the memory of your computer at a very low CPU load.

The options available with the Basler pylon Camera Software Suite let you

- change parameters and control the camera by using a standalone GUI known as the Basler pylon Viewer.
- change parameters and control the camera from within your software application using the Basler pylon SDKs.
- obtain information about the USB camera device and other USB devices connected to your host computer by using the Basler pylon USB Configurator.

The remaining sections in this chapter provide an introduction to the tools.

### 3.1.1 pylon Viewer

The pylon Viewer is included in the Basler pylon Camera Software Suite. It is a standalone application that lets you view and change most of the camera's parameter settings via a GUI-based interface. Using the pylon Viewer is a very convenient way to get your camera up and running quickly during your initial camera evaluation or a camera design-in for a new project.

For more information about using the pylon Viewer, see the *Installation and Setup Guide for Cameras Used with Basler pylon for Windows* (AW000611).

## 3.1.2 pylon USB Configurator

The pylon USB Configurator is included in the Basler pylon Camera Software Suite besides the Basler pylon IP Configurator and the Basler pylon Camera Link Configurator. The pylon USB Configurator is a standalone application. It allows you to

- obtain information about the architecture of the device tree to which your camera is connected and about the USB devices, including your camera
- automatically generate support information for Basler technical support.

For more information about generating support information, see Section 8.3 on [page 355](#).

For more information about using the pylon USB Configurator, see the *Installation and Setup Guide for Cameras Used with Basler pylon for Windows* (AW000611).

## 3.1.3 pylon SDKs

Three pylon SDKs are part of the Basler pylon Camera Software Suite:

- pylon SDK for C++ (Windows and Linux)
- pylon SDK for C (Windows)
- pylon SDK for .NET / C# (Windows)

Each SDK includes an application programming interface (API), a set of sample programs, and documentation:

- You can access all of the camera's parameters and control the camera's full functionality from within your application software by using the matching pylon API (C++, C, or .NET).
- The sample programs illustrate how to use the pylon API to parameterize and operate the camera.
- For each environment (C++, C, and .NET), a *Programmer's Guide and Reference Documentation* is available. The documentation gives an introduction to the pylon API and provides information about all methods and objects of the API.



# 4 Camera Functional Description

This chapter provides an overview of the camera's functionality from a system perspective. The overview will aid your understanding when you read the more detailed information included in the later chapters of the user's manual.

## 4.1 Overview for Cameras with CCD Sensor

Cameras with CCD sensor are listed in Section 1.3.1 on [page 3](#).

The cameras provide features such as global shutter and electronic exposure time control.

Exposure start and exposure time can be controlled by parameters transmitted to the camera via the Basler pylon API and the USB 3.0 interface. There are also parameters available to set the camera for single frame acquisition or continuous frame acquisition.

Exposure start can also be controlled via an externally generated "frame start trigger" signal applied to a camera input line (hardware frame start trigger; HWFSTrig). The HWFSTrig signal facilitates periodic or non-periodic frame acquisition start. Exposure modes are available that allow the length of exposure time to be set for a pre-programmed period of time or to be directly controlled by the HWFSTrig signal.

Accumulated charges are read out of the sensor when exposure ends. At readout, accumulated charges are transported from the sensor's light-sensitive elements (pixels) to the vertical shift registers (see Figure 33 on [page 65](#)). The charges from the bottom row of pixels in the array are then moved into a horizontal shift register. Next, the charges are shifted out of the horizontal register. All shifting is clocked according to the camera's internal data rate. Shifting continues in a row-wise fashion until all image data has been read out of the sensor.

As the charges move out of the horizontal shift register, they are converted to voltages proportional to the size of each charge. Each voltage is then amplified by a Variable Gain Control (VGC) and digitized by an Analog-to-Digital converter (ADC). After each voltage has been amplified and digitized, it passes through an FPGA and into an image buffer.

The pixel data leaves the image buffer and passes back through the FPGA to a controller where it is assembled into data packets. The packets are then transmitted by bulk transfer via a USB 3 compliant cable to a USB 3 host adapter of the host computer. The controller also handles transmission and receipt of control data such as changes to the camera's parameters.

The image buffer between the sensor and the controller allows data to be read out of the sensor at a rate that is independent of the data transmission rate between the camera and the host computer. This ensures that the data transmission rate has no influence on image quality.

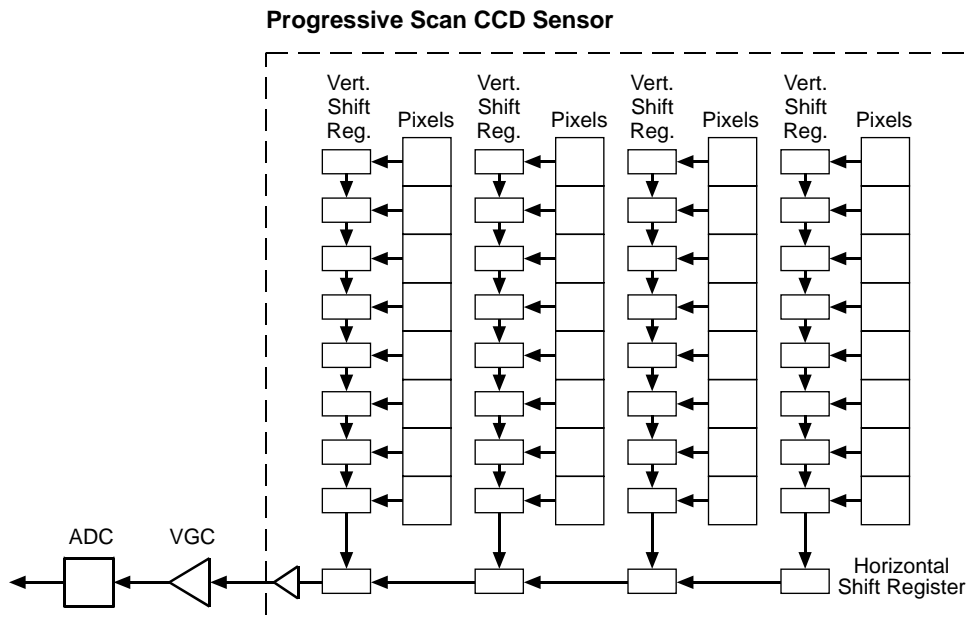

Fig. 33: CCD Sensor Architecture - Progressive Scan Sensors

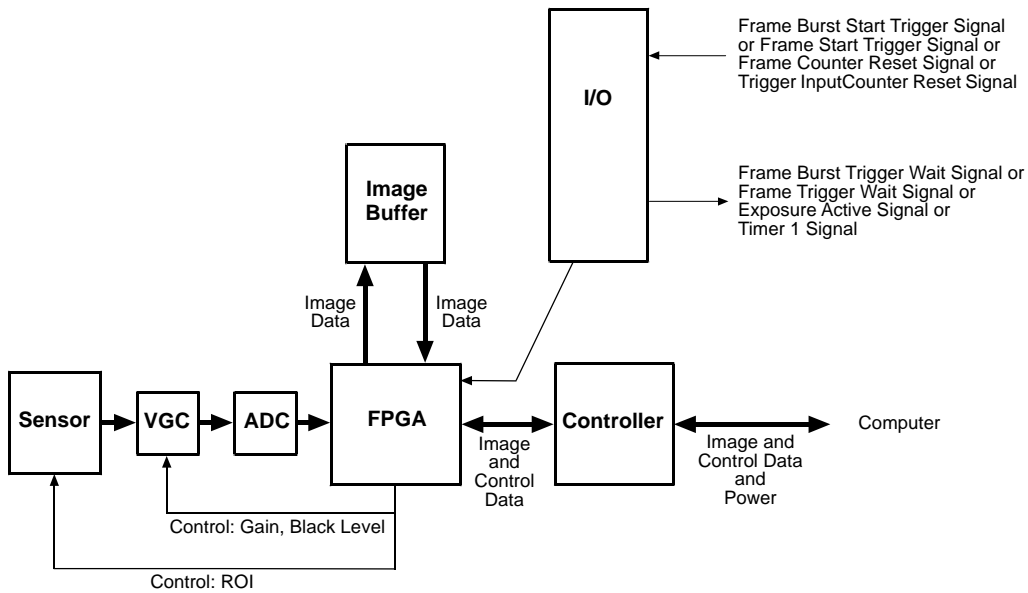

Fig. 34: Camera Block Diagram

## 4.2 Overview for Cameras with CMOS Sensor

Cameras with CMOS sensor are listed in Section 1.3.2 on [page 7](#).

The cameras provide functionalities such as an electronic rolling shutter or a global shutter (see Section 6.6 on [page 148](#)), and electronic exposure time control.

Exposure start and exposure time can be controlled by parameters transmitted to the camera via the Basler pylon API and the USB 3.0 interface. There are also parameters available to set the camera for single frame acquisition or continuous frame acquisition.

Exposure start can also be controlled via an externally generated "frame start trigger" signal applied to a camera input line (hardware frame start trigger; HWFSTrig). The HWFSTrig signal facilitates periodic or non-periodic frame acquisition start. Exposure modes are available that allow the length of exposure time to be set for a pre-programmed period of time or, with the exception of some camera models, to be directly controlled by the HWFSTrig signal.

During exposure, electrical charges accumulate in the sensor's pixels. After exposure was ended, the accumulated charges are read out of the sensor. At readout, the charges are transported from the row's light-sensitive elements (pixels) to the analog processing controls (see Figure 35 on [page 67](#)). As the charges move through the analog controls, they are converted to voltages proportional to the size of each charge. Each voltage is then amplified by a Variable Gain Control (VGC). Next the voltages are digitized by an Analog-to-Digital converter (ADC). After the voltages have been amplified and digitized, they are passed through the sensor's digital controls for additional signal processing. The digitized pixel data leaves the sensor, passes through an FPGA, and moves into a buffer.

The pixel data leaves the buffer and passes back through the FPGA to a controller where it is assembled into data packets. The packets are then transmitted by bulk transfer via a USB 3 compliant cable to a USB 3 host adapter of the host computer. The controller also handles transmission and receipt of control data such as changes to the camera's parameters.

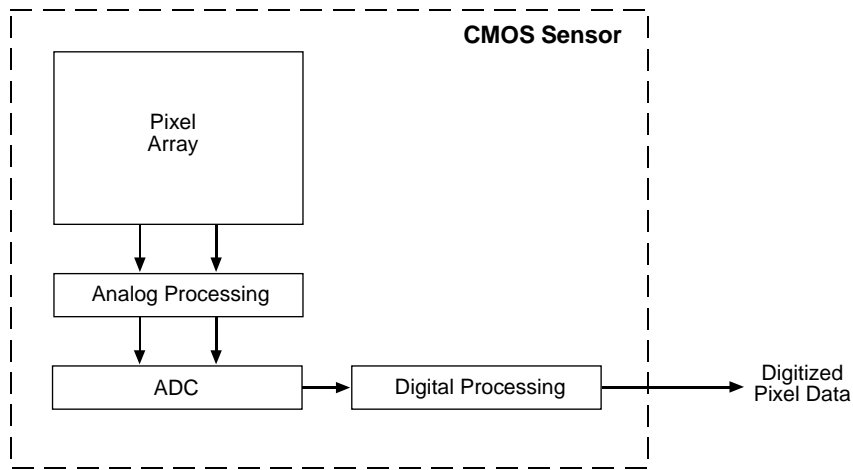

Fig. 35: CMOS Sensor Architecture

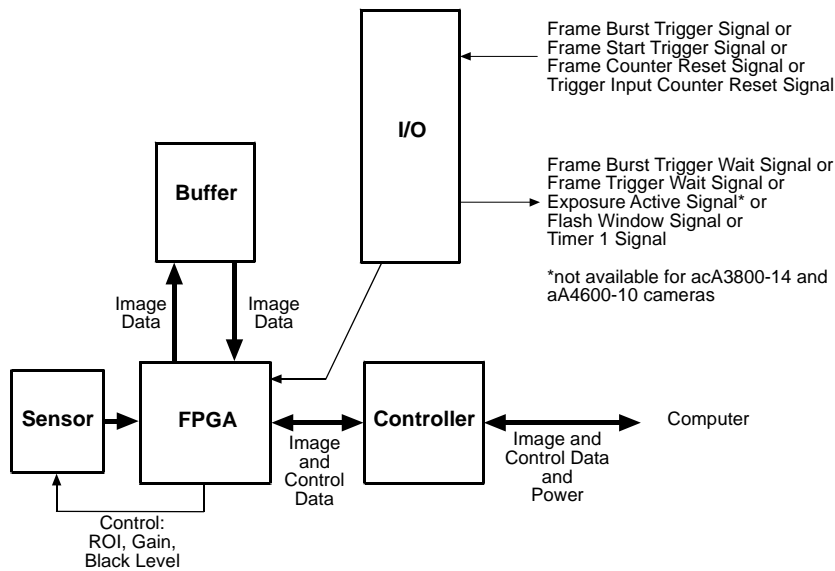

Fig. 36: Camera Block Diagram

# 5 Physical Interface

This chapter provides detailed information, such as pinouts and voltage requirements, for the physical interface on the camera. This information will be especially useful during your initial design-in process. The chapter also includes information about the required cables connecting to the camera.



Note that Basler recommends specific external components - host adapters, cables, hubs - for use with Basler ace USB 3.0 cameras. For recommended external components, see the Basler website: [www.baslerweb.com](http://www.baslerweb.com)

## 5.1 General Description of the Camera Connections

The camera is interfaced to external circuitry via connectors located on the back of the housing:

- A 6-pin connector used to provide access to the camera's I/O lines
- A USB 3.0 Micro-B port used to provide a (nominal) 5 Gbit/s SuperSpeed data transfer connection.

There is also a LED indicator located on the back of the camera.

Figure 37 shows the location of the two connectors and the LED.

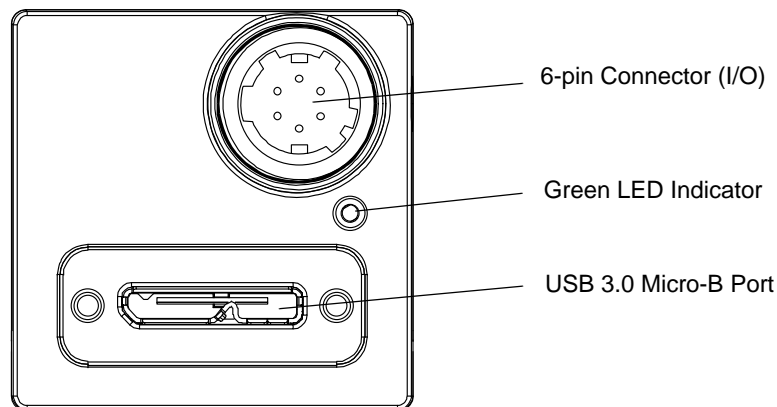

Fig. 37: Camera Connectors

## 5.2 Camera Connector Pin Numbering and Assignments

### 5.2.1 6-pin Connector Pin Numbering and Assignments

The 6-pin connector is used to access the physical input and output lines on the camera. The pin numbering for the 6-pin connector is as shown in Figure 38.

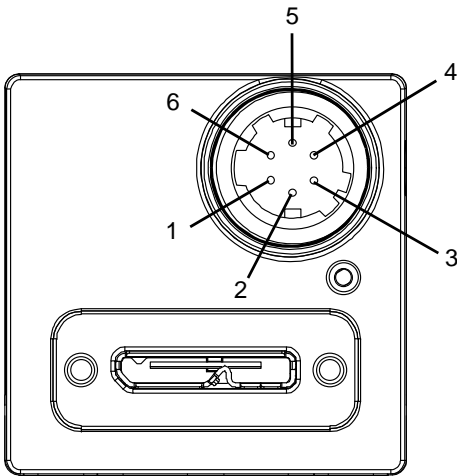

Fig. 38: Pin Numbering for the 6-pin Connector

The pin assignments and designations for the 6-pin connector are shown in Table 20.

| Pin | Designation | Function                                  |
|-----|-------------|---|
| 1   | Line 3      | Direct-coupled General Purpose I/O (GPIO) |
| 2   | Line 1      | Opto-isolated I/O IN                      |
| 3   | Line 4      | Direct-coupled General Purpose I/O (GPIO) |
| 4   | Line 2      | Opto-isolated I/O OUT                     |
| 5   | -           | Ground for opto-isolated I/O              |
| 6   | -           | Ground for direct-coupled GPIO            |

Table 20: Pin Assignments for the 6-pin Connector and Related Designations

## 5.2.2 USB 3.0 Micro-B Port Pin Numbering and Assignments

The USB 3.0 Micro-B port provides a USB 3.0 connection to supply power to the camera and to transmit image data and control signals.

Pin numbering and pin assignments adhere to the Universal Serial Bus 3.0 standard.

## 5.3 Camera Connector Types

### 5.3.1 6-pin Connector

The 6-pin connector on the camera is a Hirose micro receptacle (part number HR10A-7R-6PB) or the equivalent.

The recommended mating connector is the Hirose micro plug (part number HR10A-7P-6S) or the equivalent.

Contact your Basler sales representative to order cable assemblies.

### 5.3.2 USB 3.0 Micro-B Port

The USB 3.0 Micro-B port for the camera's USB 3.0 connection is a standard Micro-B USB 3.0 connector with screw lock.

The recommended mating connector is any standard Micro-B USB 3.0 plug.

Suitable cables terminated with screw-lock connectors are available from Basler. Contact your Basler sales representative to order cable assemblies.

## 5.4 LED Indicator

There is a green LED indicator on the back of the camera housing (see [Figure 37](#)). When the LED is lit, it indicates that the camera is operating.

## 5.5 Camera Cabling Requirements



Note that Basler highly recommends USB 3.0 and I/O cables that are offered as Basler accessories. For recommended accessories, see the Basler website: [www.baslerweb.com](http://www.baslerweb.com)

### 5.5.1 USB 3.0 Cable

Use a high-quality USB 3.0 cable. If possible only use a cable that was obtained from Basler. To avoid EMI, the cable must be shielded. Close proximity to strong high-frequency electromagnetic fields should be avoided in your installation.

To obtain a suitable cable from Basler. Contact your Basler sales representative to order cable assemblies.

### 5.5.2 I/O Cable

A single I/O cable is used to connect to the camera's I/O lines. In your installation, close proximity to strong high-frequency electromagnetic fields should be avoided.

The end of the I/O cable that connects to the camera must be terminated with a Hirose micro plug (plug type HR10A-7P-6S) or the equivalent. The cable must be wired to conform with the pin assignments shown in the pin assignment table.

The maximum length of the I/O cable is at least 10 m. The cable must be shielded and have twisted pair wire to ensure that input signals are correctly received.

The required 6-pin Hirose plug is available from Basler. Basler also offers cable assemblies that are terminated with a 6-pin Hirose plug on one end and unterminated on the other. Contact your Basler sales representative to order connectors or cables.

#### **NOTICE**

An incorrect plug can damage the 6-pin I/O connector.

The plug on the cable that you attach to the camera's 6-pin I/O connector must have 6 female pins. Using a plug designed for a smaller or a larger number of pins can damage the connector.







Note that direct-coupled GPIO lines have the advantage of working with very short delays compared to opto-isolated I/O lines.



Note also that the direct-coupled GPIOs are distinctly more susceptible to EMI than the opto-isolated I/Os. Under harsh EMI conditions, GPIOs can turn out not to be usable at all.

Accordingly, use of the GPIOs in an environment with elevated risk of EMI calls for taking additional measures like, e.g. using shorter cables.

## 5.6 Camera Power

Camera power must be supplied to the camera via the USB 3.0 cable plugged into the camera's USB 3.0 Micro-B port.

|   |  |
|---|--|
|  |  <b>DANGER</b>  |
|   | <p><b>Electric Shock Hazard</b></p> <p>Risk of Burn or Death.</p> <p>The power supply used for supplying camera power must meet the Safety Extra Low Voltage (SELV) and Limited Power Source (LPS) requirements.</p> <p>If you use a powered hub as part of the USB 3.0 connection, the powered hub must meet the SELV and LPS requirements.</p> |

|   |  |
|---|--|
|  |  <b>WARNING</b>   |
|   | <p><b>Fire Hazard</b></p> <p>Risk of Burn</p> <p>The power supply used for supplying camera power must meet the Limited Power Source (LPS) requirements.</p> <p>A suitable power supply is available from Basler. Contact your Basler sales representative to order a power supply.</p> <p>If you use a powered hub as part of the USB 3.0 connection, the powered hub must meet the LPS requirements.</p> |

|   |
|---|
| <b>NOTICE</b>   |
| <p>Voltage outside of the specified range can cause damage.</p> <p>The camera's nominal operating voltage is +5 VDC, effective at the camera's USB 3.0 port.</p> <p>You must supply camera power in accord with the Universal Serial Bus 3.0 specification and involve a power supply that meets the Safety Extra Low Voltage (SELV) and Limited Power Source (LPS) requirements.</p> |

Power consumption is as shown in the specification tables in [Chapter 1](#) of this manual.

## 5.7 Opto-isolated Input (Pin 2/Line 1)

The camera is equipped with one dedicated opto-isolated input line designated as Line 1. The input line is accessed via the 6-pin connector on the back of the camera (pin 2, see [Figure 38](#)).

In addition, the camera has two direct-coupled GPIO lines, Line 3 and Line 4, that can both be used as input lines. They are described in Section 5.9 on [page 80](#).



The opto-isolated input line has the advantage of being distinctly more robust against EMI than a GPIO line used as an input. However, when using the opto-isolated input line, the delays involved are longer than for a GPIO line.

### 5.7.1 Electrical Characteristics



#### DANGER

##### **Electric Shock Hazard**

Risk of Burn or Death.

The power supply used must meet the Safety Extra Low Voltage (SELV) and Limited Power Source (LPS) requirements.

A suitable power supply is available from Basler. Contact your Basler sales representative to order a power supply.



#### WARNING

##### **Fire Hazard**

Risk of Burn

The power supply used must meet the Limited Power Source (LPS) requirements.

A suitable power supply is available from Basler. Contact your Basler sales representative to order a power supply.

**NOTICE**

Voltage outside of the safe operating voltage range can cause damage.

The safe operating I/O supply voltage range

- for the opto-isolated input line differs from the safe operating voltage range for the opto-isolated output line (see Section 5.8.1 on [page 77](#)) and direct-coupled GPIO lines (Section 5.9 on [page 80](#)).
- for the I/O input lines of Basler ace USB 3.0 cameras can differ from the safe operating voltage ranges for the I/O input lines of other Basler cameras.

You must supply power within the safe operating voltage range.

The following voltage requirements and information apply to the camera's opto-isolated I/O input line (pin 2 of the 6-pin connector; Line 1).

| Voltage            | Significance   |
|--------------------|--|
| +30.0 VDC          | Absolute maximum. The absolute maximum must never be exceeded. Otherwise, the camera can be damaged and the warranty becomes void. |
| +0 to +24 VDC      | Safe operating I/O input voltage range.  |
| +0 to +1.4 VDC     | The voltage indicates a logical 0 (inverter disabled).<br>"voltage level low" of Section 5.13 on <a href="#">page 107</a> .        |
| > +1.4 to +2.2 VDC | Region where the transition threshold occurs; the logical status is not defined in this region.                                    |
| > +2.2 VDC         | The voltage indicates a logical 1 (inverter disabled).<br>"voltage level high" of Section 5.13 on <a href="#">page 107</a> .       |

Table 21: Voltage Requirements and Information for the Opto-isolated Input Line

**Note:** A minimum current of 5 mA must be provided to the I/O input line.

[Figure 39](#) shows a schematic for the opto-isolated input line. The absolute maximum input supply voltage is +30.0 VDC. The current draw for the input line is between 5 mA and 15 mA.

As an example, the use of a TTL or CMOS logic gate in the external circuit is shown.

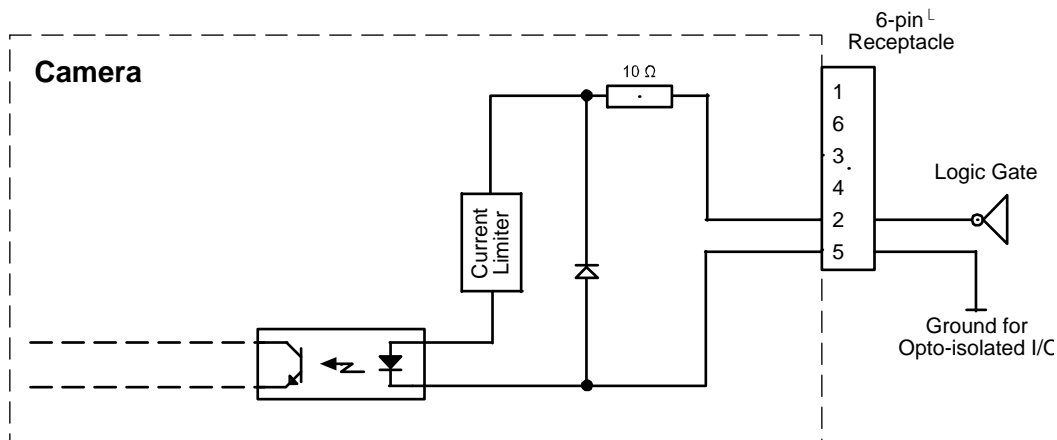

Fig. 39: Opto-isolated Input Line Schematic with a Typical External Circuit (Simplified)

For more information about input line pin assignments and pin numbering, see Section 5.2 on [page 69](#).

For more information about how to use an externally generated frame start trigger (ExFSTrig) signal to control acquisition start, see Section 6.4 on [page 128](#).

For more information about configuring the input line, see Section 5.11 on [page 93](#).

## 5.8 Opto-isolated Output (Pin 4/Line 2)

The camera is equipped with one dedicated opto-isolated output line designated as Line 2. The output line is accessed via the 6-pin connector on the back of the camera (pin 4, see [Figure 38](#)).

In addition, the camera has two direct-coupled GPIO lines, Line 3 and Line 4, that can both be used as output lines. They are described in Section 5.9 on [page 80](#).



The opto-isolated output line has the advantage of being distinctly more robust against EMI than a GPIO line used as an output. However, when using the opto-isolated output line, the delays involved are longer than for a GPIO line.

### 5.8.1 Electrical Characteristics



#### **DANGER**

##### **Electric Shock Hazard**

Risk of Burn or Death.

The power supply used must meet the Safety Extra Low Voltage (SELV) and Limited Power Source (LPS) requirements.

A suitable power supply is available from Basler. Contact your Basler sales representative to order a power supply.



#### **WARNING**

##### **Fire Hazard**

Risk of Burn

The power supply used must meet the Limited Power Source (LPS) requirements.

A suitable power supply is available from Basler. Contact your Basler sales representative to order a power supply.

## NOTICE

Voltage outside of the safe operating voltage range can cause damage.

- The safe operating I/O supply voltage range for the opto-isolated output line differs from the safe operating voltage range for the opto-isolated input line (see Section 5.7.1 on [page 74](#)).
- The safe operating I/O supply voltage range for the I/O output lines of Basler ace USB 3.0 cameras can differ from the safe operating voltage ranges for the I/O output lines of other Basler cameras.

You must supply power within the safe operating voltage range.

## Voltages

The following voltage requirements and information apply to the opto-isolated I/O output line (pin 4 of the 6-pin connector; Line 2).

| Voltage         | Significance   |
|-----------------|--|
| +30.0 VDC       | Absolute maximum. The absolute maximum must never be exceeded. Otherwise, the camera can be damaged and the warranty becomes void. |
| +3.3 to +24 VDC | Safe operating I/O output supply voltage range.  |
| < +3.3 VDC      | The I/O output can operate erratically.  |

Table 22: Voltage Requirements and Information for the Opto-isolated Output Line

## Currents

- The leakage current in the "off" state should usually not exceed approximately 60  $\mu\text{A}$  and will typically be much lower (e.g. approximately 4  $\mu\text{A}$  at 25 °C (+77 °F) housing temperature). The actual leakage current depends on camera operating temperature and production spread of electronic components.
- The **maximum** load current allowed through the output circuit is **50 mA**.
- There is no specific minimum load current but you need to consider several facts:
  - the leakage current will have stronger effect when load currents are low
  - the propagation delay of the output increases as load currents decrease
  - higher-impedance circuits tend to be more susceptible to EMI
  - higher currents yield higher voltage drop on long cables.

Figure 40 shows a schematic for the opto-isolated output line.

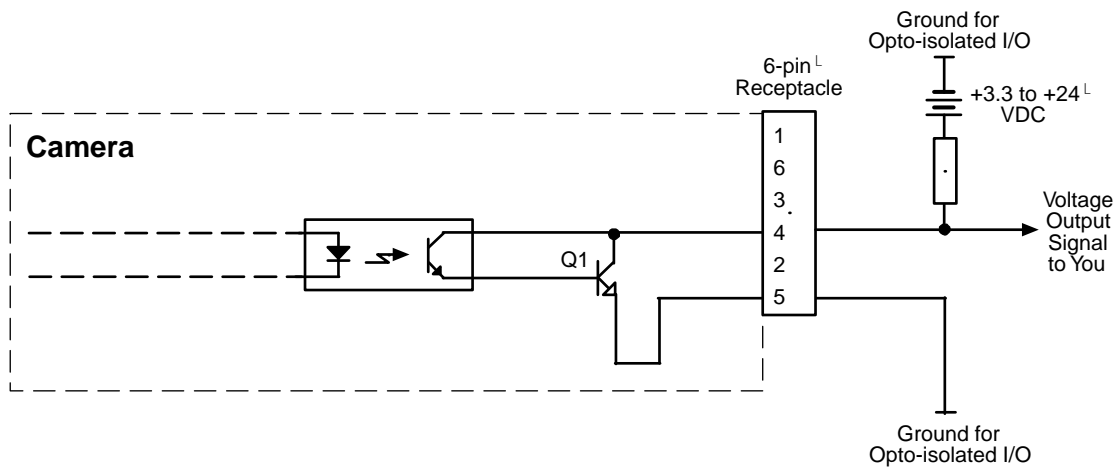

Fig. 40: Opto-isolated Output Line Schematic with a Typical Voltage Output Circuit (Simplified)

Figure 41 shows a typical circuit you can use to monitor the output line with an LED. In this example, the voltage for the external circuit is +24 VDC. Current in the circuit is limited by an external resistor.

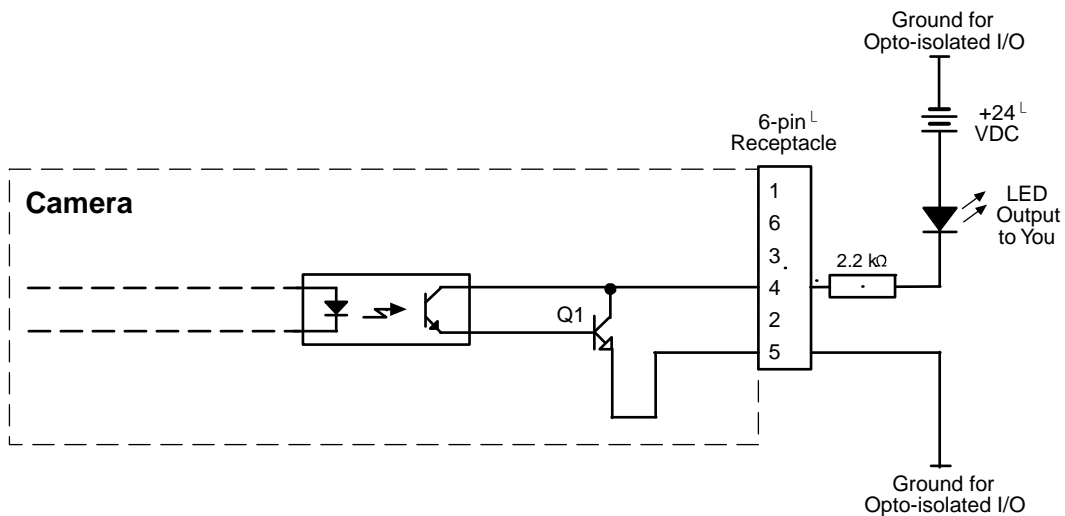

Fig. 41: Opto-isolated Output Line Schematic with a Typical LED Output Signal at +24 VDC for the External Circuit (Simplified)

For more information about output line pin assignments and pin numbering, see Section 5.2 on page 69.

For more information about the Exposure Active signal, see Figure 6.8.1 on page 167.



## 5.9 Direct-coupled General Purpose I/O (GPIO; Pin 1/Line 3, Pin 3/Line 4)



### 5.9.1 Introduction



The camera has two direct-coupled GPIO lines that are accessed via pins 1 and 3 of the 6-pin connector on the back of the camera (see [Figure 38](#)).

The GPIO lines can be set to operate as inputs to the camera or to operate as camera outputs. The GPIO lines are designated as Line 3 and Line 4 (see also Section 5.2.1 on [page 69](#)).

The direct-coupled GPIO lines are compatible with TTL signals.

The next sections describe the differences in the GPIO electrical functionality when the lines are set to operate as inputs and when they are set to operate as outputs.

|  |  |
|--|--|
|  |  <b>DANGER</b>  |
|  | <p><b>Electric Shock Hazard</b></p> <p>Risk of Burn or Death.</p> <p>The power supply used must meet the Safety Extra Low Voltage (SELV) and Limited Power Source (LPS) requirements.</p> <p>A suitable power supply is available from Basler. Contact your Basler sales representative to order a power supply.</p> |

|   |  |
|---|--|
|  |  <b>WARNING</b>   |
|   | <p><b>Fire Hazard</b></p> <p>Risk of Burn</p> <p>The power supply used must meet the Limited Power Source (LPS) requirements.</p> <p>A suitable power supply is available from Basler. Contact your Basler sales representative to order a power supply.</p> |

**NOTICE**

Applying incorrect electrical signals to the camera's GPIO lines can severely damage the camera.

1. Before you connect any external circuitry to a GPIO line, we strongly recommend that you set a GPIO line to operate as an input or as an output (according to your needs).
2. Once a line is properly set, make sure that you only apply electrical signals to the line that are appropriate for the line's current setting.



Direct-coupled GPIO lines have the advantage of working with very short delays compared to opto-isolated I/O lines.

The direct-coupled GPIO lines are, however, distinctly more susceptible to electromagnetic interference.

We therefore strongly recommend to only use the direct-coupled GPIO lines when significant electromagnetic interference will not occur.

## 5.9.2 Setting a GPIO Line for Input or Output

You can set a GPIO line to operate as an input or output line. To set the mode of operation, you must set the line mode for the GPIO line.

### Setting a GPIO Line for Input or Output

**To set a GPIO line for input or output using Basler pylon:**

1. Set the LineSelector parameter to select the GPIO line that you want to configure.
2. Set the LineMode parameter as desired to Input or Output.

You can set the LineSelector and LineMode parameter values from within your application software by using the Basler pylon API. The following code snippet illustrates using the API to select a GPIO line and to set the LineMode parameter value. As an example, the code snippet assumes that you want to select Line 3 and set it to Input:

```
// Select GPIO line Line 3
camera.LineSelector.SetValue(LineSelector_Line3).
// Set the line mode for the selected GPIO line
camera.LineMode.SetValue(LineMode_Input);
```

You can also use the Basler pylon Viewer application to easily set the parameters.

For more information about the pylon API and the pylon Viewer, see Section 3.1 on [page 62](#).

## 5.9.3 Operation as an Input

This section describes the electrical operation of a GPIO line when the line has been set to operate as an input.

### 5.9.3.1 Electrical Characteristics

#### **NOTICE**

Voltage outside of the safe operating voltage range can cause damage.  
You must supply power within the safe operating voltage range.

The following I/O supply voltage requirements apply to a direct-coupled GPIO line when the line is set as an input.

| Voltage            | Significance   |
|--------------------|--|
| +30.0 VDC          | Absolute maximum. The absolute maximum must never be exceeded. Otherwise, the camera can be damaged and the warranty becomes void. |
| +0 to + 5.0 VDC    | Safe operating input voltage range (the minimum external pull up voltage is 3.3 VDC as illustrated in Figure 43).                  |
| +0 to +0.8 VDC     | The voltage indicates a logical 0 (inverter disabled).<br>"voltage level low" of Section 5.13 on <a href="#">page 107</a> .        |
| > +0.8 to +2.0 VDC | Region where the transition threshold occurs; the logical status is not defined in this region.                                    |
| > +2.0 VDC         | The voltage indicates a logical 1 (inverter disabled).<br>"voltage level high" of Section 5.13 on <a href="#">page 107</a> .       |

Table 23: Voltage Requirements for a Direct-coupled GPIO Line Set as an Input

Your application must be able to accept 2 mA (sink current) from the direct-coupled GPIO input line without exceeding +0.8 VDC, the upper limit of the low status. The current draw for high-level input current is < 100  $\mu$ A.

Figure 42 shows the applicable electrical circuit when a GPIO line is set to operate as an input. The figure is drawn to specifically apply to pin 1 (Line 3) as an example. However, with the necessary modifications, the figure applies equally to pin 3 (Line 4).

The figure shows, as an example, the use of a TTL or CMOS logic gate in the external circuit. A different example for an external circuit is shown in Figure 43.

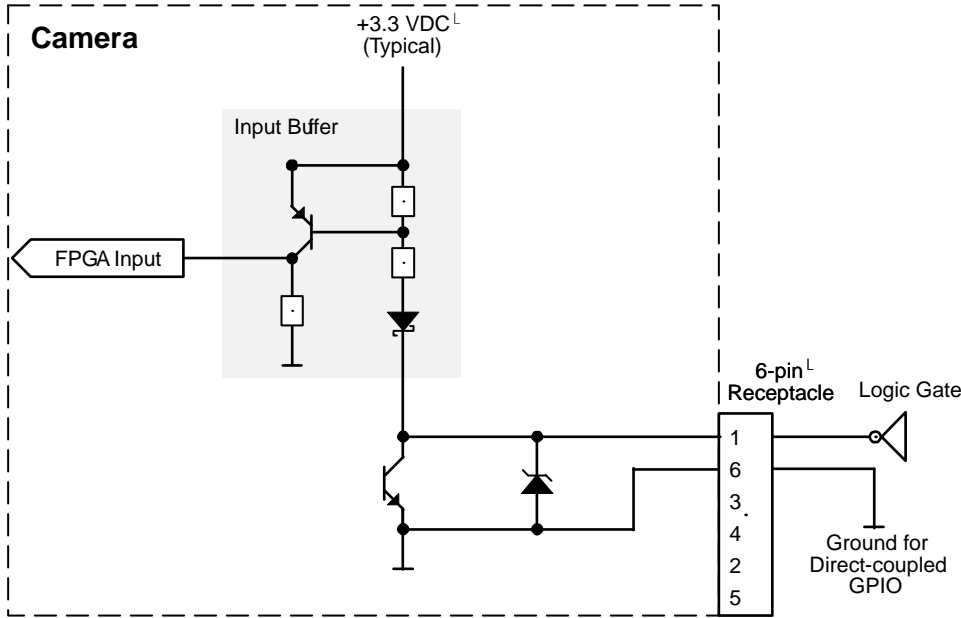

Fig. 42: Direct-coupled GPIO Line Schematic with the GPIO Line Set as an Input and with a Typical External Circuit Using a Logic Gate (Illustration for Pin 1 as an Example; Simplified)

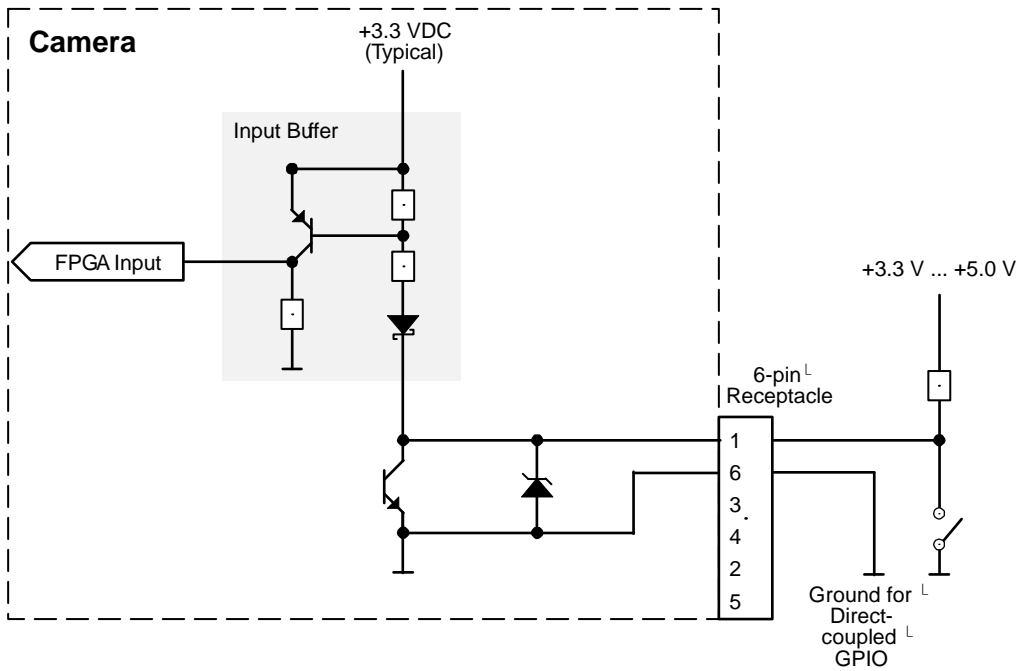

Fig. 43: Direct-coupled GPIO Line Schematic with the GPIO Line Set as an Input and with a Typical External Circuit (Illustration for Pin 1 as an Example; Simplified)

For more information about GPIO pin assignments and pin numbering, see Section 5.2.1 on [page 69](#).

For more information about setting the GPIO line operation, see Section 5.11 on [page 93](#) and Section 5.12 on [page 97](#).

## 5.9.4 Operation as an Output

This section describes the electrical operation of the GPIO line when the line has been set to operate as an output.

### 5.9.4.1 Electrical Characteristics

#### NOTICE

Voltage outside of the safe operating voltage range can cause damage.  
You must supply power within the safe operating voltage range.



To ensure that the specified voltage levels for signals transmitted out of the camera will be reached even under less than favorable conditions (e.g. for long cable lengths, harsh EMI environment, etc.), we recommend to generally use an external pull up resistor or to connect a "high side load".

### Voltages

- The following I/O supply voltage requirements apply to a direct-coupled GPIO line when it is set as an output and when it is in the "off" state:

| Voltage         | Significance   |
|-----------------|--|
| +30.0 VDC       | Absolute maximum. The absolute maximum must never be exceeded. Otherwise, the camera can be damaged and the warranty becomes void. |
| +3.3 to +24 VDC | Safe operating direct-coupled GPIO output supply voltage range.  |
| < +3.3 VDC      | The direct-coupled GPIO output can operate erratically.  |

Table 24: Voltage Requirements for a Direct-coupled GPIO Line Set as an Output

- The following applies to a direct-coupled GPIO line when it is set as an output:
  - The camera uses an open collector with only a weak internal pull-up resistor (approximately 2 k $\Omega$ ). It is therefore likely that many applications will have to provide an additional pull-up resistor.
  - When the direct-coupled GPIO line is in the "on" state, the residual voltage will typically be approximately 0.4 V at 50 mA and 25 °C housing temperature. The actual residual voltage, however, depends on camera operating temperature, load current, and production spread.

## Currents

- The leakage current in the "off" state should usually not exceed approximately 60  $\mu\text{A}$  and will typically be much lower (e.g. approximately 4  $\mu\text{A}$  at 25  $^{\circ}\text{C}$  (+77  $^{\circ}\text{F}$ ) housing temperature). The actual leakage current depends on camera operating temperature and production spread of electronic components.
- The **maximum** load current allowed through the output circuit is **50 mA**.
- There is no specific minimum load current but you need to consider several facts:
  - the leakage current will have stronger effect when load currents are low
  - the propagation delay of the output increases as load currents decrease
  - higher-impedance circuits tend to be more susceptible to EMI
  - higher currents yield higher voltage drop on long cables.

As shown in Figure 44, shows the applicable electrical circuit when a GPIO line is set to operate as an output. The figure is drawn to specifically apply to pin 1 (Line 3) as an example but, with the necessary modifications, it equally applies to pin 3 (Line 4).

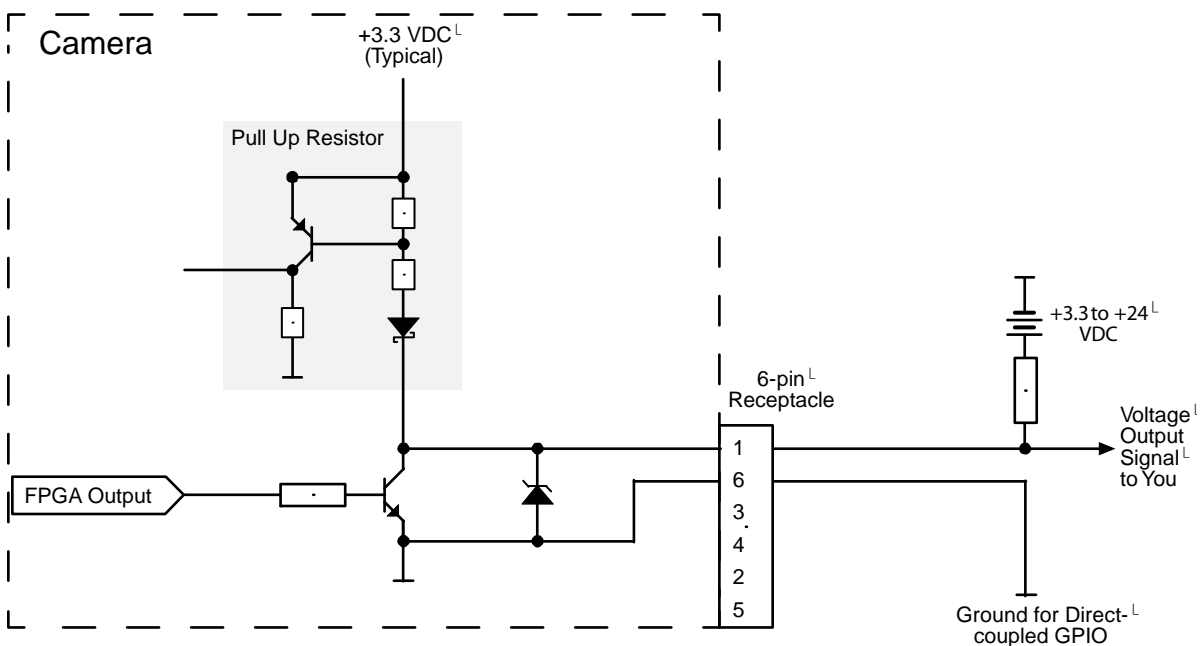

Fig. 44: Direct-coupled GPIO Line Schematic with the GPIO Line Set as an Output and with a Typical Voltage Output Circuit (Illustration for Pin 1 as an Example; Simplified)

For more information about GPIO pin assignments and pin numbering, see Section 5.2.1 on [page 69](#).

For more information about setting the GPIO line operation, see Section 5.11 on [page 93](#) and Section 5.12 on [page 97](#).

## 5.10 Temporal Performance of I/O Lines

This section describes delays ("propagation delays") resulting from the operation of the camera's input and output lines. For image acquisition, the propagation delays must be added to the delays described in Chapter 6 on [page 113](#).

You will need the information included in this section most likely only if you need microsecond accuracy when controlling camera operation via I/O lines.

All examples in this section assume that the I/O line inverters are disabled.

### 5.10.1 Introduction

As indicated in Section 5.2 on [page 69](#), the camera provides two different kinds of I/O lines:

- opto-isolated I/O lines
- direct-coupled General Purpose I/O (GPIO) lines.

The related electrical characteristics and circuit schematics are given in [Section 5.7](#) through [Section 5.9](#).

With regard to use, the two kinds of I/O lines differ mainly in these respects:

- The opto-isolated I/O lines have the advantage of being distinctly more robust against EMI than the GPIO lines.
- The propagation delays ("response times") differ between the two kinds of I/O lines.  
A propagation delay is the time that elapses between the moment when a signal voltage passes through the transition threshold and the moment when the related line status changes – or vice versa (see [Figure 45](#) for camera input and [Figure 46](#) for camera output).

The following important characteristics are apparent from [Figure 45](#) and [Figure 46](#):

- The propagation delays for the opto-isolated I/O lines are in most cases longer than for the GPIO lines. In other words, the opto-isolated I/O lines are usually "slower" than the GPIO lines.
- For each analog signal, the rising edge and the falling edge are associated with different propagation delays. The edge with the shorter propagation delay (the "fast" edge) is indicated in the figures by an asterisk.

For recommendations for use, see Section on [page 91](#).



**Note:** In order to avoid losing an external trigger signal make sure its pulse width will be long enough to provide sufficient time for the camera's input circuit to react:

The minimum required pulse width will be longer for the

- opto-isolated input line compared to a GPIO line and for a
- trigger signal using the active low state for triggering compared to a trigger signal using the active high state.

As a general rule of thumb, an external trigger pulse width of 100  $\mu$ s should be long enough for most cases.



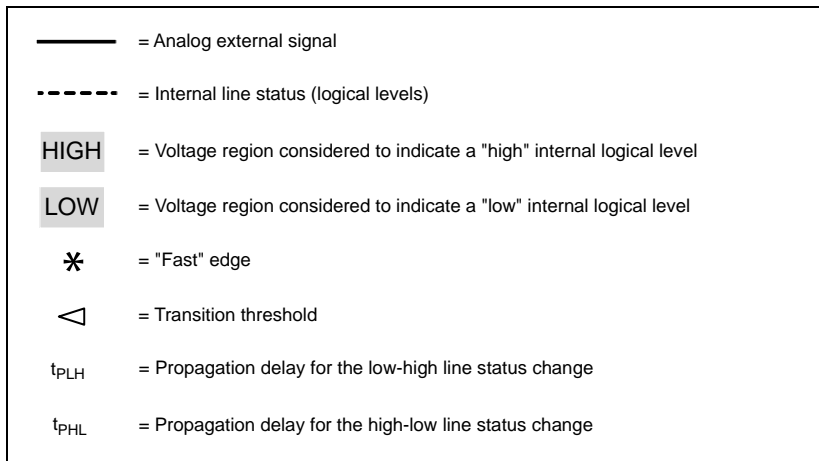

Drawing not to scale

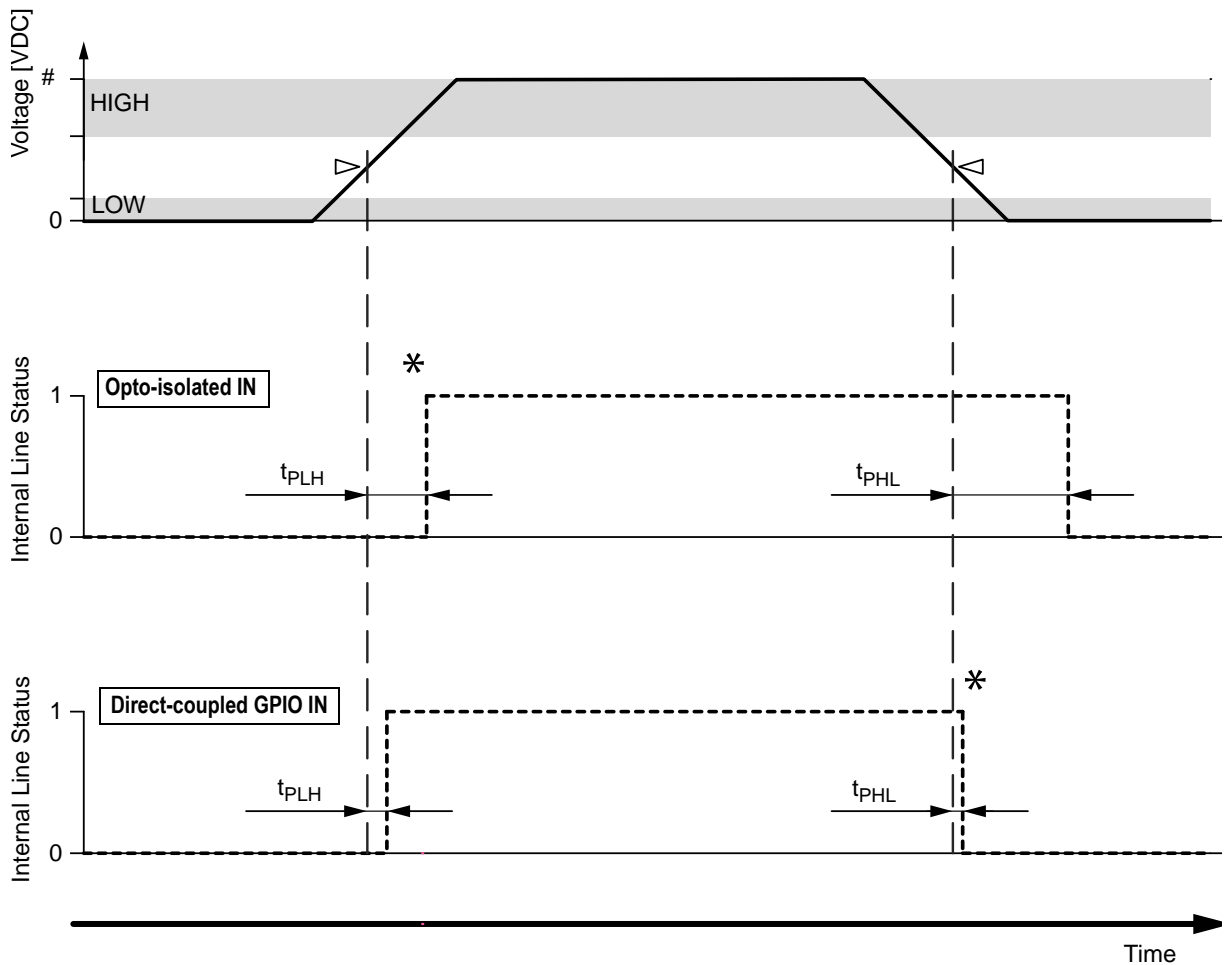

#: 3.3 - 24 VDC for opto-isolated input, >2.0 - 5.0 VDC for direct-coupled GPIO IN

Fig. 45: Analog External Signal and Associated Internal Line Status with Propagation Delays for Opto-isolated Input and Direct-coupled GPIO Inputs (Line Inverters Disabled)

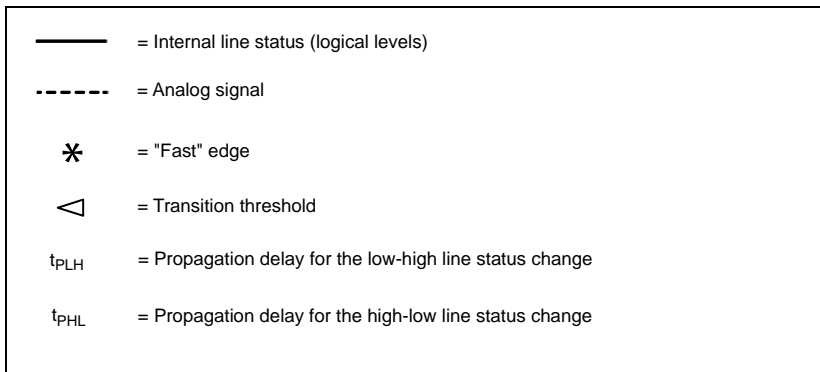

Drawing not to scale

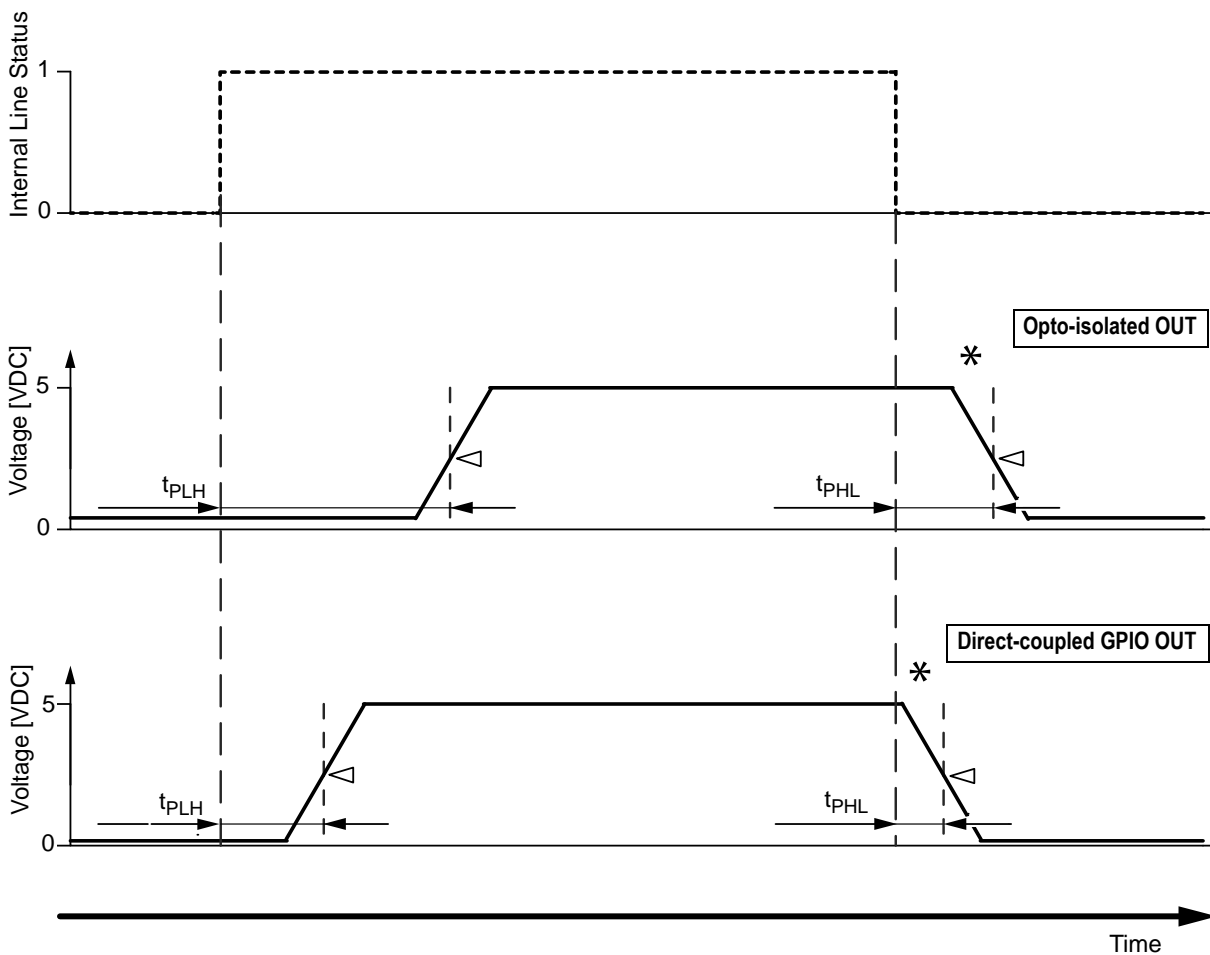

Fig. 46: Internal Line Status and Associated Output Signals with Propagation Delays for Opto-isolated Output and Direct-coupled GPIO Outputs (Line Inverters Disabled)

## 5.10.2 Factors Determining I/O Temporal Performance

A number of factors control the exact durations of propagation delays. The influence of some of the factors is, however, ill constrained or unknown. As a consequence, **generally valid and exact quantitative predictions of propagation delays are impossible.**

The following factors apply:

| Factors Influencing Camera I/O Propagation Delays   | Input            |                      | Output            |                      |
|---|------------------|----------------------|-------------------|----------------------|
|   | Opto-isolated IN | Direct-coupled GPIOs | Opto-isolated OUT | Direct-coupled GPIOs |
| Operating temperature:<br>Unknown but temperature must be within specified range; see Section 1.10.1 on <a href="#">page 51</a> .                                 | •                | 0                    | •                 | 0                    |
| Production spread:<br>Unknown   | •                | 0                    | •                 | 0                    |
| Aging (optocouplers):<br>Unknown  | •                |                      | •                 |                      |
| External I/O supply voltage:<br>Depends on application but must be within specified ranges; see <a href="#">Section 5.7</a> through <a href="#">Section 5.9</a> . | •                |                      | •                 | 0                    |
| Load resistance:<br>Depends on application  |                  |                      | •                 | 0                    |
| Load current:<br>Depends on application but must be within specified ranges; see <a href="#">Section 5.7</a> through <a href="#">Section 5.9</a> .                |                  |                      | •                 | 0                    |

Table 25: Factors Influencing Camera I/O Propagation Delays (• = major influence, 0 = minor influence)

Among the insight that can be gained from [Table 25](#) is the fact, production spread can result in different propagation delays even for cameras that were produced in one batch and that are operated under identical conditions.

## Opto-isolated I/Os and Direct-coupled GPIOs

- Generally use the "fast" edge of a signal for tight temporal control and to minimize unwanted influence on propagation delays.

The propagation delays for a "fast" edge will rarely exceed 15  $\mu$ s for an opto-isolated I/O line, and rarely 1  $\mu$ s for a direct-coupled GPIO line. Under very unfavorable conditions, propagation delays related to "slow" edges can take milliseconds.

- To minimize propagation delays related to a "fast" edge, increase the load resistance.
- To minimize propagation delays related to a "slow" edge, use an I/O supply voltage between 3.3 VDC and 5 VDC and decrease the load resistance such that a load current between 30 mA and 40 mA will result.
- Use the direct-coupled GPIO lines when you need to minimize propagation delays but mind their greater susceptibility to EMI compared to the opto-isolated I/Os.

## Opto-isolated I/Os

- When you apply current to the input and output lines for extended periods or even for most of the time you will promote aging of the optocouplers. Keep the times when current flows to a minimum to preserve stable propagation delays.



Signal edge-to-edge variation (jitter) resulting from I/O operation itself is negligible but can be introduced by your trigger signal.

To avoid jitter, make sure the rise and fall times of your trigger signals are short, preferably < 500 ns. The camera's inherent jitter is less than 100 ns, peak to peak.

### 5.10.3 Measured Propagation Delays

The measured propagation delays reported in this section (see [Table 26](#) and [Table 27](#)) are likely to be near-minimum values related to "slow" edges.

The measured propagation delays were derived from a camera production lot of 2000 cameras and are **only** valid for the specific camera operating conditions listed below. **The specific camera operating conditions were only chosen as an example. No inferences can be made for propagation delays in different operating conditions.**

Specific operating conditions:

- Housing temperature: +25 °C.
- Load resistance:  $R_L = 170 \Omega$
- I/O supply voltage:  $U_S = 5 \text{ VDC}$

| Propagation Delays for Inputs |                                       |                                      |
|-------------------------------|---------------------------------------|--------------------------------------|
|                               | Fast Edge                             | Slow Edge                            |
| Opto-isolated input           | 4.5 - 7.5 $\mu\text{s}$ (rising edge) | 19 - 28 $\mu\text{s}$ (falling edge) |
| Direct-coupled GPIO IN        | < 0.5 $\mu\text{s}$ (falling edge)    | < 1 $\mu\text{s}$ (rising edge)      |

Table 26: Propagation Delays for the Camera Inputs (+25 °C,  $R_L = 170 \Omega$ ,  $U_S = 5 \text{ VDC}$ )

| Propagation Delays for Outputs |                                    |                                     |
|--------------------------------|------------------------------------|-------------------------------------|
|                                | Fast Edge                          | Slow Edge                           |
| Opto-isolated output           | 3 - 6 $\mu\text{s}$ (falling edge) | 27 - 38 $\mu\text{s}$ (rising edge) |
| Direct-coupled GPIO OUT        | < 0.5 $\mu\text{s}$ (falling edge) | < 2.5 $\mu\text{s}$ (rising edge)   |

Table 27: Propagation Delays for the Camera Outputs (+25 °C,  $R_L = 170 \Omega$ ,  $U_S = 5 \text{ VDC}$ , Transition Threshold = 2.0 V)

For the graphical illustration of propagation delays, see [Figure 45](#) and [Figure 46](#).

## 5.11 Configuring Input Lines and Signals

### 5.11.1 Selecting an Input Line as the Source Signal for a Camera Function

You can select input line Line 1 and GPIO lines Line 3 and Line 4, if configured for input, to act as the source signal for the following camera functions:

- Frame Burst Start trigger
- Frame Start trigger
- Counter 1 reset

Whenever a proper electrical signal is applied to the selected line, the camera will recognize the signal as signal for the selected camera function.

For example, when Line 1 was selected to act as the source signal for the frame burst start trigger, camera will recognize an electrical signal applied to Line 1 as a frame burst start trigger.

Note: When you apply an electrical signal to the input line the electrical signal must be appropriately timed for the function.

For detailed information about selecting an input line to act as the source signal for

- the frame burst start trigger and for details about how the frame burst start trigger operates, see Section 6.3 on [page 120](#).
- the frame start trigger and for details about how the frame start trigger operates, see Section 6.4 on [page 128](#).
- counter 1 reset and for details about how the counter value chunk feature operates, see Section 7.23.3.6 on [page 348](#).



By default, input line Line 1 is selected as the source signal for the frame start trigger.

## 5.11.2 Input Line Debouncers

The debouncer feature aids in discriminating between valid and invalid input signals and only lets valid signals pass to the camera. The debouncer value specifies the minimum time that an input signal must remain high or remain low in order to be considered a valid input signal.

|   |   |
|---|---|
|  | <p>We recommend setting the debouncer value so that it is slightly greater than the longest expected duration of an invalid signal.</p> <p>Setting the debouncer to a value that is too short will result in accepting invalid signals. Setting the debouncer to a value that is too long will result in rejecting valid signals.</p> |
|---|---|

Note that the debouncer delays a valid signal between its arrival at the camera and its transfer. The duration of the delay will be determined by the debouncer value.

Figure 47 illustrates how the debouncer filters out invalid input signals, i.e. signals that are shorter than the debouncer value. The diagram also illustrates how the debouncer delays a valid signal.

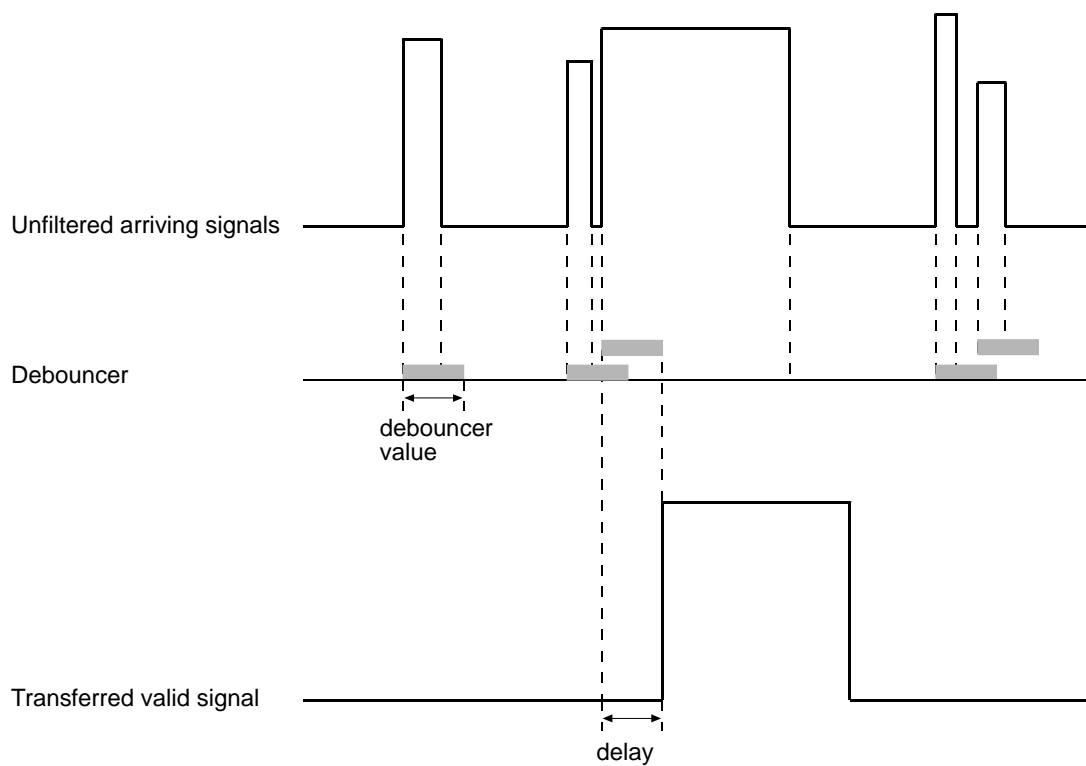

Timing charts are not drawn to scale

Fig. 47: Filtering of Input Signals by the Debouncer

## Setting the Debouncer

You can set a debouncer value for input line Line 1 and for GPIO lines Line 3 and Line 4 if configured for input:

The debouncer value is determined by the value of the Line Debouncer Time parameter value. The parameter is set in microseconds and can be set in a range from 0 to 20,000  $\mu$ s.

### To set the debouncer:

1. Use the Line Selector to select, for example, input line Line 1.
2. Set the value of the Line Debouncer Time parameter.

You can set the Line Selector and the value of the Line Debouncer Time parameter from within your application software by using the Basler pylon API. The following code snippet illustrates using the API to set the selector and the parameter value:

```
// Select the input line
camera.LineSelector.SetValue(LineSelector_Line1);
// Set the parameter value e.g. to 10 microseconds
camera.LineDebouncerTime.SetValue(10.0);
```

You can also use the Basler pylon Viewer application to easily set the parameters.

For more information about the pylon API and the pylon Viewer, see Section 3.1 on [page 62](#).



## 5.11.3 Input Line Inverter

You can set input line Line 1 and GPIO lines Line 3 and Line 4, if configured for input, to invert or not to invert the incoming electrical signal. Therefore, the inverter setting is one of the factors defining whether a given electrical signal level will be considered to correspond to a "high" or "low" logical line status.



If you enable or disable the inverter one frame acquisition will automatically occur.

### To set the invert function for an input line:

1. Use the Line Selector to select, for example, Line 1.
2. Set the value of the Line Inverter parameter to true to enable inversion on the selected line or to false to disable inversion.

You can set the Line Selector and the Line Inverter parameter value from within your application software by using the pylon API. The following code snippet illustrates using the API to set the selector and the parameter value:

```
// Select the input line
camera.LineSelector.SetValue(LineSelector_Line1);
// Enable the line inverter on the selected line
camera.LineInverter.SetValue(true);
```

You can also use the Basler pylon Viewer application to easily set the parameters.

For more information about the pylon API and the pylon Viewer, see Section 3.1 on [page 62](#)

## 5.12 Configuring Output Lines and Signals

### 5.12.1 Selecting a Source Signal for an Output Line

To make a physical output line useful, you must select a source signal for the line. You can select output line Line 2 and GPIO lines Line 3 and Line 4, if configured for output.

The camera has several standard output signals available and any one of them can be selected to act as the source signal for an output line.

The camera has these standard output signals available:

- Frame Burst Trigger Wait
- Frame Trigger Wait
- Exposure Active (not available for acA3800-14 and acA4600-10 cameras)
- Flash Window
- Timer 1 Active
- User Output 1, User Output 2 or User Output 3, depending on the output line. For more information, see Section 5.12.3 on [page 101](#).

#### To set a camera output signal as the source signal for an output line:

1. Use the Line Selector to select, for example, output line Line 2.
2. Set the value of the Line Source Parameter to one of the available output signals or to user settable. This will set the source signal for the output line.

The following code snippet illustrates using the API to set the selector and the parameter value:

```
// Select the output line Line 2
camera.LineSelector.SetValue(LineSelector_Line2);
// Select the Flash Window signal as the source signal
camera.LineSource.SetValue(LineSource_FlashWindow);
```



- By default, the User Output 1 signal is selected as the source signal for output line Line 2.
- The Exposure Active signal is not available for acA3800-14 and acA4600-10 cameras. We recommend using the Flash Window signal instead.

You can set the Line Selector and the Line Source parameter value from within your application software by using the Basler pylon API.

You can also use the Basler pylon Viewer application to easily set the parameters.

For more information about

- the pylon API and the pylon Viewer, see Section 3.1 on [page 62](#).
- the frame burst trigger wait signals and frame trigger wait signals, see Section 6.8.4 on [page 172](#).
- the exposure active signal, see Section 6.8.1 on [page 167](#).
- the flash window signal, see Section 6.6.2.3 on [page 157](#) and Section 6.8.2 on [page 169](#).
- working with the timer output signal, see Section 5.12.6 on [page 105](#)
- setting the status of a user settable output line, see Section 5.12.3 on [page 101](#).
- the electrical characteristics of the opto-isolated output line, see Section 5.8 on [page 77](#).

## 5.12.2 Line Minimum Output Pulse Width

It can occur that an output signal sent by the camera will not be detected by some receivers. This can happen when the output signal is too narrow or if it reaches its new signal level too slowly.

To ensure reliable detection, the Line Minimum Output Pulse Width feature allows you to increase the signal width ("pulse width") to a minimum width:

- If the signal width of the original output signal is narrower than the set minimum the Line Minimum Output Pulse Width feature will increase the signal width to the set minimum before the signal is sent out of the camera (see the figure below).
- If the signal width of the original output signal is equal to or wider than the set minimum the Line Minimum Output Pulse Width feature will have no effect. The signal will be sent out of the camera with unmodified signal width.

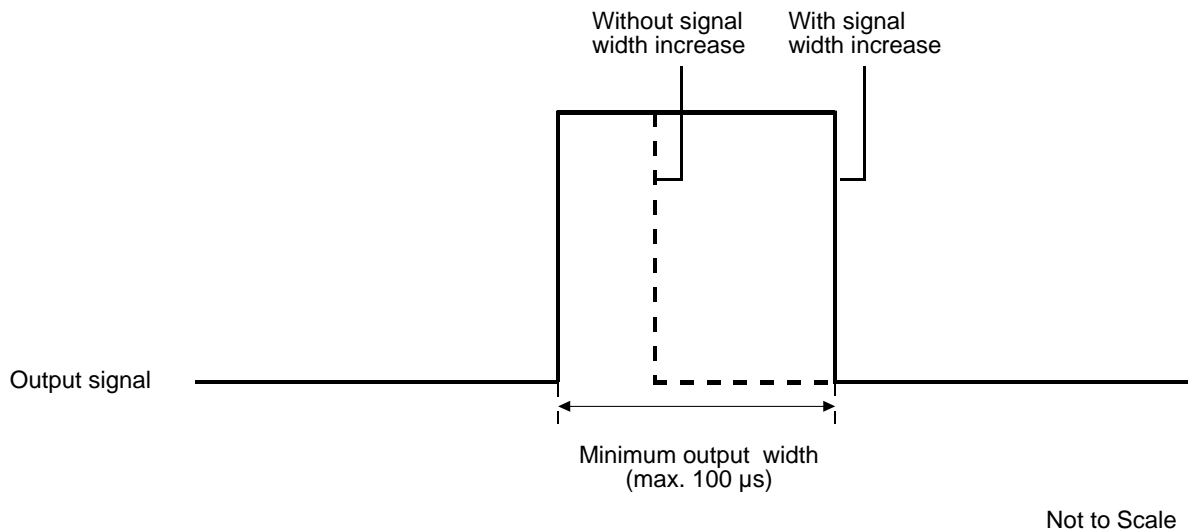

Fig. 48: Increasing the Signal Width of an Output Signal

## Setting the Line Minimum Output Pulse Width

The minimum output pulse width is determined by the value of the `LineMinimumOutputPulseWidth` parameter. The parameter can be set in a range from 0 to 100  $\mu\text{s}$ .

### To set the line minimum output pulse width parameter value using Basler pylon:

1. Use the Line Selector to select a camera output line, for example Line 2.
2. Set the value of the `LineMinimumOutputPulseWidth` parameter.

You can set the Line Selector and the value of the `LineMinimumOutputPulseWidth` parameter from within your application software by using the pylon API.

The following code snippet illustrates using the API to set the selector and the parameter value. As an example, the opto-isolated output line (Line 2) is selected and the minimum output pulse width is set to 10.0  $\mu\text{s}$ :

```
// Select the output line
camera.LineSelector.SetValue(LineSelector_Line2);
// Set the parameter value to 10.0 microseconds
camera.LineMinimumOutputPulseWidth.SetValue(10.0);
```

For detailed information about using the pylon API, refer to the Basler pylon Programmer's Guide and API Reference.

You can also use the Basler pylon Viewer application to easily set the parameters.

For more information about the pylon Viewer, see Section 3.1 on [page 62](#).

## 5.12.3 Setting the Status of an Individual User Settable Output Line

As mentioned in the previous section, you can designate a camera's output line as "user settable" by means of the UserOutput parameters. If you have designated an output line as user settable, you can use the UserOutputValue parameter to set the status of the output line.

For each output line, a specific UserOutput parameter is available to set the line as "user settable":

- UserOutput 1 is available for output line Line 2
- UserOutput 2 is available for GPIO line Line 3 if the line is configured for output
- UserOutput 3 is available for GPIO line Line 4 if the line is configured for output.

### To set the status of a user settable output line:

1. Use the User Output Selector to select, for example, output line Line 2.
2. Set the value of the User Output Value parameter to true (1) or false (0). This will set the status of the output line.

You can set the Output Selector and the User Output Value parameters from within your application software by using the Basler pylon API. The following code snippet illustrates using the API to designate an output line as user settable, set the status of the output line, and get informed about its current status:

```
// Set output line Line 2 to user settable
camera.LineSelector.SetValue(LineSelector_Line2);
camera.LineSource.SetValue(LineSource_UserOutput1);
// Set the status of output line Line 2
camera.UserOutputSelector.SetValue(UserOutputSelector_UserOutput1);
camera.UserOutputValue.SetValue(true);
// Get informed about the current user output value setting for output line Line 2
bool b = camera.UserOutputValue.GetValue();
```

You can also use the Basler pylon Viewer application to easily set the parameters.



If you have the line inverter enabled on an output line and the line is designated as user settable, the user setting initially sets the status of the line which is then inverted by the line inverter.

For more information about the pylon API and the pylon Viewer, see Section 3.1 on [page 62](#).

## 5.12.4 Setting and Checking the Status of All User Settable Output Lines

You can set and check the current status of all output lines with a single operation by using the UserOutputValueAll parameter value. The UserOutputValueAll parameter value is expressed as a hexadecimal number in the Basler pylon Viewer and as a 32-bit word in the Basler pylon API (with 0 as a constant value on bit 0).

As shown in Figure 49, each bit from bit 1 through 3 is associated with a different user settable output line. The status of each output line is expressed by its related binary parameter value: If a bit is 0, it indicates that the line status of the associated line is currently low. If a bit is 1, it indicates that the line status of the associated line is currently high.

When you read the hexadecimal number of the UserOutputValueAll parameter value, convert it to its binary equivalent to make the current status of each output line immediately apparent.

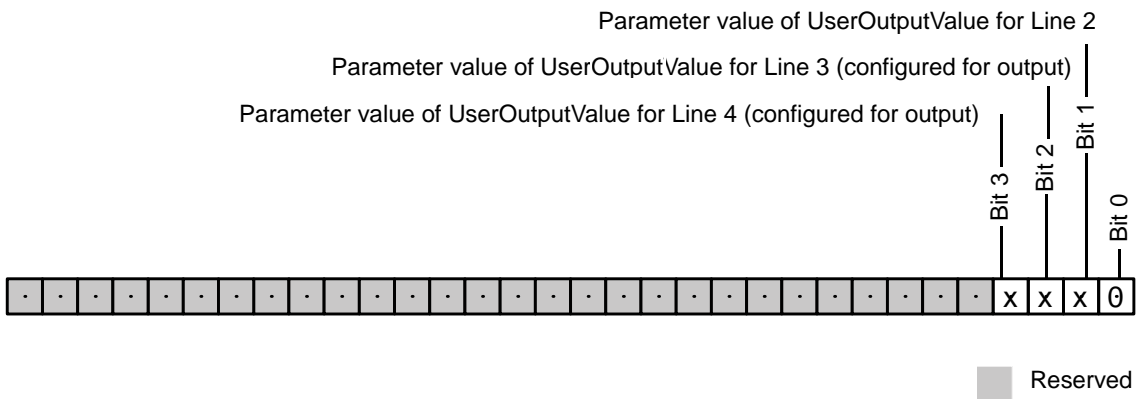

Fig. 49: Bit Field of the UserOutputValueAll Parameter: Bit Numbers and Assignment of Output Lines

See Section 5.13.1 on page 107 for details about the relation between line status and its determining factors, e.g. electrical signal level, line inverter setting, and user output setting.

### To set and check the status of all user outputs with a single operation:

1. Set the value of the UserOutputValueAll parameter to set all user output values. For example: If you wanted to set each one of bits 1 through 3 to 1 you would set the UserOutputValueAll parameter value to xE or to 14 (the hexadecimal and decimal equivalents of 1110).
2. Read the value of the UserOutputValueAll parameter to determine the current settings of all user output values.

You can set and read the UserOutputValueAll parameter value from within your application software by using the Basler pylon API. The following code snippet illustrates using the API to read the parameter value. In this example, the UserOutputValueAll parameter value is set to 0:

```
// Setting all user output values with a single operation
camera.UserOutputValueAll.SetValue(0);
// Reading all user output values with a single operation
int64_t i = camera.UserOutputValueAll.GetValue();
```

Set the value of the User Output Value parameter to true (1) or false (0). This will set the status of the output line.



## 5.12.5 Output Line Inverter

You can set output line Line 2 and GPIO lines Line 3 and Line 4 if configured for output, to invert or not to invert the electrical output signal.



If you enable or disable the inverter one frame acquisition will automatically occur.

### To set the invert function for an output line:

1. Use the Line Selector to select, for example, Line 2.
2. Set the value of the Line Inverter parameter to true to enable inversion on the selected line or to false to disable inversion.

You can set the Line Selector and the Line Inverter parameter value from within your application software by using the pylon API. The following code snippet illustrates using the API to set the selector and the parameter value:

```
// Enable the line inverter on output line Line 2
camera.LineSelector.SetValue(LineSelector_Line2);
camera.LineInverter.SetValue(true);
```

You can also use the Basler pylon Viewer application to easily set the parameters.

For more information about the pylon API and the pylon Viewer, see Section 3.1 on [page 62](#).

## 5.12.6 Working With the Timer Output Signal

As mentioned in Section 5.12.1 on [page 97](#), the source signal for an output line can be set to Timer 1 Active. The camera has one timer designated as Timer 1. When you set the source signal for the output line to Timer 1 Active, Timer 1 will be used to supply the signal to the output line.

Timer 1 operates as follows:

- A trigger source event occurs that starts the timer.
- A delay period begins to expire.
- When the delay expires, the timer signal goes high and a duration period begins to expire.
- When the duration period expires, the timer signal goes low.

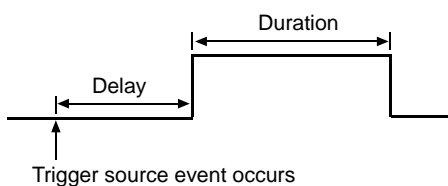

Fig. 50: Timer Signal

The following trigger source events are available:

- All cameras except acA3800-14 and acA4600-10 cameras: Exposure Start is currently the only trigger source event available to start Timer 1.
- acA3800-14 and acA4600-10 cameras only: Flash Window Start is currently the only trigger source event available to start Timer 1.

If you require the timer signal to be high when the timer is triggered and to go low when the delay expires, simply set the output line to invert.

Timer 1 Active can serve as the source signal for output line Line 2 and for the GPIO lines Line 3 and Line 4 if configured for output. For information about selecting the Timer 1 Active as the source signal for an output line, see Section 5.12.1 on [page 97](#).

### 5.12.6.1 Setting the Timer Trigger Source

#### To set the timer trigger source for Timer 1:

1. Use the Timer Selector to select Timer 1.
2. Set the value of the Timer Trigger Source parameter to Exposure Start. This will set the selected timer to use the start of exposure to start timer 1.



The Exposure Start signal is not available for acA3800-14 and acA4600-10 cameras. For these cameras, the Flash Window Start signal is available as the Timer Trigger Source.

If the exposure time is too short for the flash window to open (see the note in Section 6.6.2 on [page 151](#)) timer 1 will start nonetheless when exposure starts for the last row of the current ROI. This assumes that Flash Window Start is selected as the Timer Trigger Source.

You can set the Trigger Selector and the Timer Trigger Source parameter value from within your application software by using the Basler pylon API. The following code snippet illustrates using the API to set the selector and the parameter value:

```
camera.TimerSelector.SetValue(TimerSelector_Timer1);  
camera.TimerTriggerSource.SetValue(TimerTriggerSource_ExposureStart);
```

You can also use the Basler pylon Viewer application to easily set the parameters.

For more information about the pylon API and the pylon Viewer, see Section 3.1 on [page 62](#).

### 5.12.6.2 Setting the Timer Delay Time

You can set the Timer 1 delay by setting the Timer Delay parameter. The units for setting this parameter are  $\mu\text{s}$  and the value can be set in increments of 1  $\mu\text{s}$ .

#### To set the delay for Timer 1:

1. Use the Timer Selector to select Timer 1.
2. Set the value of the Timer Delay parameter.

You can set the Timer Selector and the Timer Delay parameter value from within your application software by using the Basler pylon API. The following code snippet illustrates using the API to set the selector and the parameter value:

```
camera.TimerSelector.SetValue(TimerSelector_Timer1);  
camera.TimerDelay.SetValue(100.0);
```

You can also use the Basler pylon Viewer application to easily set the parameters.

For more information about the pylon API and the pylon Viewer, see Section 3.1 on [page 62](#).

### 5.12.6.3 Setting the Timer Duration Time

You can set the Timer 1 duration by setting the Timer Duration parameter. The units for setting this parameter are  $\mu\text{s}$  and the value can be set in increments of 1  $\mu\text{s}$ .

#### To set the duration for Timer 1:

1. Use the Timer Selector to select Timer 1.
2. Set the value of the Timer Duration parameter.

You can set the Timer Selector and the Timer Duration parameter value from within your application software by using the Basler pylon API. The following code snippet illustrates using the API to set the selector and the parameter value:

```
camera.TimerSelector.SetValue(TimerSelector_Timer1);  
camera.TimerDuration.SetValue(10.0);
```

You can also use the Basler pylon Viewer application to easily set the parameters.

For more information about the pylon API and the pylon Viewer, see Section 3.1 on [page 62](#).

## 5.13 Significance of I/O Line Status

### 5.13.1 Line Status for Input Lines

This section informs about the relation between input line status and certain external conditions. The opto-isolated and the GPIO input lines are considered.

The line status information depends, among others, on whether the input line inverter is disabled or enabled (Section 5.11.3 on [page 96](#)).

Make sure the ground for opto-isolated I/O and the ground of the power supply for the opto-isolated input line are connected to the same ground.

For applicable pins, see [Table 20 on page 69](#), and for line schematics, see [Figure 39](#), [Figure 42](#), and [Figure 43](#).

### Line Status for Opto-isolated Input Line (Line 1)

| External Conditions  |                                      | Resulting Status                    |                   |
|----------------------|--------------------------------------|-------------------------------------|-------------------|
| Line Inverter Status | Electrical Status                    | Logical Line Status Parameter Value | Binary Expression |
| Disabled             | Input Open or Connection at z Status | False                               | 0                 |
|                      | Voltage Level Low                    | False                               | 0                 |
|                      | Voltage Level High                   | True                                | 1                 |
| Enabled              | Input Open or Connection at z Status | True                                | 1                 |
|                      | Voltage Level Low                    | True                                | 1                 |
|                      | Voltage Level High                   | False                               | 0                 |

Table 28: Line Status for Different External Conditions: Line 1 (Opto-isolated Input)

### Line Status for Direct-coupled GPIO Lines (Line 3, Line 4), Set for Input

| External Conditions  |                                      | Resulting Status                    |                   |
|----------------------|--------------------------------------|-------------------------------------|-------------------|
| Line Inverter Status | Electrical Status                    | Logical Line Status Parameter Value | Binary Expression |
| Disabled             | Input Open or Connection at z Status | True                                | 1                 |
|                      | Voltage Level Low                    | False                               | 0                 |
|                      | Voltage Level High                   | True                                | 1                 |
| Enabled              | Input Open or Connection at z Status | False                               | 0                 |
|                      | Voltage Level Low                    | True                                | 1                 |
|                      | Voltage Level High                   | False                               | 0                 |

Table 29: Line Status for Different External Conditions: Line 3, Line 4 (Direct-coupled GPIO Input)

## 5.13.2 Line Status for Output Lines

This section informs about the relation between output line status and certain external conditions. The opto-isolated and the GPIO output lines are considered.

The line status information depends, among others, on whether the output line inverter is disabled or enabled (Section 5.12.5 on [page 104](#)) and on the current setting of the UserOutputValue parameter (Section 5.12.3 on [page 101](#)).

Two types of installation are considered (see [Figure 51](#)):

- The output line is connected to the external power supply with no external pull-up resistor involved (A: "external pull-up resistor disconnected"; not useful for the opto-isolated output line).
- The output line is connected to the external power supply via an external pull-up resistor (B: "external pull-up resistor connected").

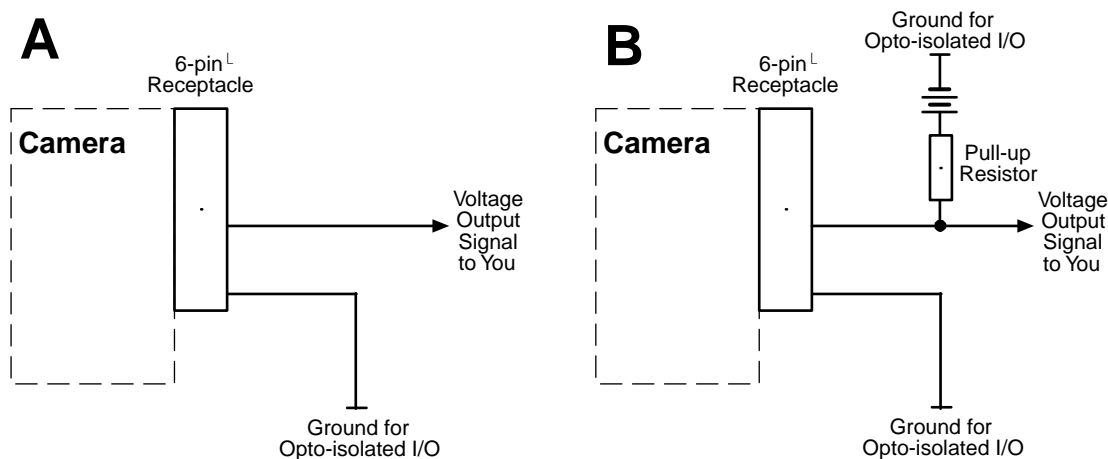

Fig. 51: Use of an External Pull-up Resistor With an Output Line: **A**: No External Pull-up Resistor Connected, **B**: External Pull-up Resistor Connected



The output circuits display open collector circuit behavior. The GPIO lines are, however, equipped with a weak internal pull up resistor.

Make sure the ground for opto-isolated I/O and the ground of the power supply for the opto-isolated output line are connected to the same ground.

For applicable pins, see [Table 20 on page 69](#), and for line schematics, see [Figure 40](#), [Figure 41](#), and [Figure 44](#).

## Line Status for Opto-isolated Output Line (Line 2)

| External Conditions                |                      |                    | Resulting Status                    |                   |               |
|------------------------------------|----------------------|--------------------|-------------------------------------|-------------------|---------------|
| External Pull Up Connection Status | Line Inverter Status | User Output Status | Logical Line Status Parameter Value | Binary Expression | Voltage Level |
| Pull-Up Connected                  | Disabled             | Disabled           | True                                | 1                 | High          |
|                                    |                      | Enabled            | False                               | 0                 | Low           |
|                                    | Enabled              | Disabled           | False                               | 0                 | Low           |
|                                    |                      | Enabled            | True                                | 1                 | High          |
| Pull-Up Disconnected               | Disabled             | Disabled           | True                                | 1                 | Not defined   |
|                                    |                      | Enabled            | False                               | 0                 | Low           |
|                                    | Enabled              | Disabled           | False                               | 0                 | Low           |
|                                    |                      | Enabled            | True                                | 1                 | Not defined   |

Table 30: Line Status for Different External Conditions: Line 2 (Opto-isolated Output)

## Line Status for Direct-coupled GPIO Lines (Line 3, Line 4), Set for Output

| External Conditions                |                      |                    | Resulting Status                    |                   |               |
|------------------------------------|----------------------|--------------------|-------------------------------------|-------------------|---------------|
| External Pull Up Connection Status | Line Inverter Status | User Output Status | Logical Line Status Parameter Value | Binary Expression | Voltage Level |
| Pull-Up Connected                  | Disabled             | Disabled           | True                                | 1                 | High          |
|                                    |                      | Enabled            | False                               | 0                 | Low           |
|                                    | Enabled              | Disabled           | False                               | 0                 | Low           |
|                                    |                      | Enabled            | True                                | 1                 | High          |
| Pull-Up Disconnected               | Disabled             | Disabled           | True                                | 1                 | High          |
|                                    |                      | Enabled            | False                               | 0                 | Low           |
|                                    | Enabled              | Disabled           | False                               | 0                 | Low           |
|                                    |                      | Enabled            | True                                | 1                 | High          |

Table 31: Line Status for Different External Conditions: Lines 3 and 4 (Direct-coupled GPIO Output)

## 5.14 Checking I/O Line Status

### 5.14.1 Checking the Status of All I/O Lines

You can check the current status of all input and output lines with a single operation by reading the value of the LineStatusAll parameter.

The status depends on whether an electrical signal is applied to the line, on the voltage level, and on the settings of the line inverter and user output (output lines). In addition, the "line logic" as set by the factory, determines fundamentally whether a given electrical signal level will be considered to correspond to a "true" or "false" line status. Positive line logic is used for the input lines.



The line status of a GPIO line (Line 3, Line 4) does not depend on the configuration of the GPIO line for input or output.

The LineStatusAll parameter value is expressed as a hexadecimal number in the Basler pylon Viewer and as a 32-bit word that you can read using the Basler pylon API.

As shown in [Figure 52](#), each bit from bit 0 through 3 is associated with a different I/O line. The status of each I/O line is expressed by its related binary parameter value: If a bit is 0, it indicates that the line status of the associated line is currently low. If a bit is 1, it indicates that the line status of the associated line is currently high.

When you read the hexadecimal number of the LineStatusAll parameter value, convert it to its binary equivalent to make the current status of each I/O line immediately apparent.

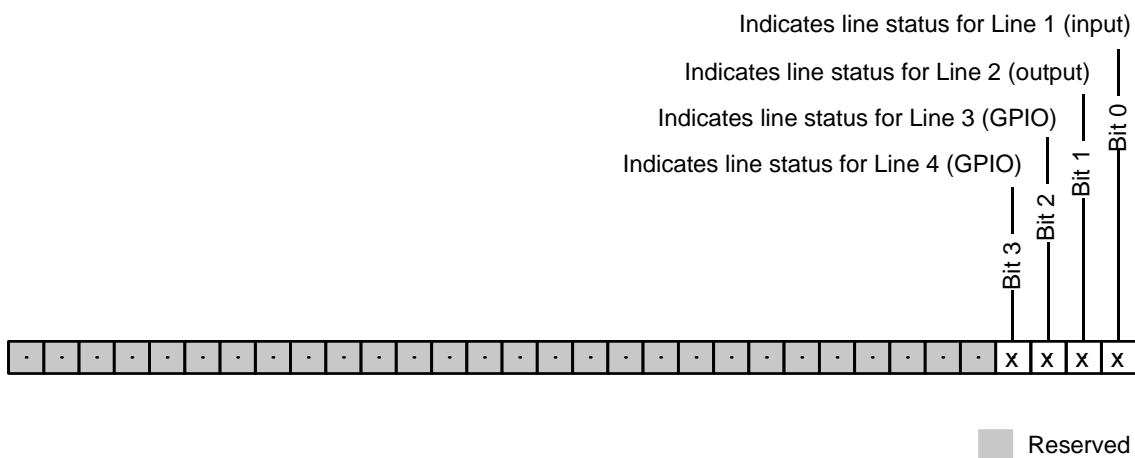

Fig. 52: Bit Field of the LineStatusAll Parameter: Bit numbers and Assignment of I/O Lines



See Section 5.13.1 on [page 107](#) for details about the relation between line status and its determining factors, e.g. electrical signal level, line inverter setting, and user output setting.

For information about checking and setting the status of output lines, see Section 5.12.3 on [page 101](#) and Section 5.12.4 on [page 102](#).

#### To check the status of all I/O lines with a single operation using the pylon API:

1. Read the value of the LineStatusAll parameter to determine the current status of all I/O lines. You can read the Line Status All parameter value from within your application software by using the Basler pylon API. The following code snippet illustrates using the API to read the parameter value:

```
// Getting informed about the line status of all I/O lines
int64_t i = camera.LineStatusAll.GetValue();
```

You can also use the Basler pylon Viewer application to easily set the parameters.

For more information about the pylon API and the pylon Viewer, see Section 3.1 on [page 62](#).

## 5.14.2 Checking the Status of an Individual I/O Line

The following example illustrates checking the line status of output line Line 2.

#### To check the status of an I/O line:

1. Use the Line Selector parameter to select, for example, the opto-isolated output line Line 2 (pin 4).
2. Read the value of the Line Status parameter to determine the current status of the line. "True" means the line's status is currently high and "false" means the line's status is currently low.

You can set the Line Selector and read the Line Status parameter value from within your application software by using the Basler pylon API. The following code snippet illustrates using the API to set the selector and read the parameter value:

```
// Select output line Line 2 and read the status
camera.LineSelector.SetValue(LineSelector_Line2);
bool b = camera.LineStatus.GetValue();
```

You can also use the Basler pylon Viewer application to easily set the parameters.

For more information about the pylon API and the pylon Viewer, see Section 3.1 on [page 62](#).

# 6 Image Acquisition Control

This section provides detailed information about controlling image acquisition. You will find information about triggering image acquisition, about setting the exposure time for image acquisition, about controlling the camera's image acquisition rate, and about how the camera's maximum allowed image acquisition rate can vary depending on the current camera settings.



The examples in this section mainly refer to I/O lines that are dedicated for either input (Line1) or output (Line2). Note, however, that you can also configure the GPIO lines (Line 3, Line 4) for input or output.

## 6.1 Overview

This section presents an overview of the elements available for controlling the acquisition of images. Reading this section will give you an idea about how these elements fit together and will help you understand the detailed information in the sections below.

Four major elements are involved in controlling the acquisition of images:

- Acquisition start and acquisition stop commands and the acquisition mode parameter
- Frame burst start trigger
- Frame start trigger
- Exposure time control

Keep in mind that "frame" is typically used to mean a single acquired image.

When reading the material in this chapter, also refer to Figure 53 on [page 115](#) and to the use case diagrams in Section 6.11 on [page 187](#). These diagrams illustrate the roles of the acquisition start and stop commands, the acquisition mode, the frame burst start trigger, and the frame start trigger.

### Acquisition Start and Stop Commands and the Acquisition Mode

The Acquisition Start command prepares the camera to acquire frames. The camera cannot acquire frames unless an Acquisition Start command has first been executed.

The Acquisition Mode parameter has a direct bearing on how the Acquisition Start command operates.

If the Acquisition Mode parameter is set to Single Frame, you can only acquire one frame after executing an Acquisition Start command. When one frame has been acquired, the Acquisition Start command will expire. Before attempting to acquire another frame, you must execute a new Acquisition Start command.

If the Acquisition Mode parameter is set to Continuous, an Acquisition Start command does not expire after a single frame is captured. Once an Acquisition Start command has been executed, you can acquire as many frames as you like. The Acquisition Start command will remain in effect until you execute an Acquisition Stop command. Once an Acquisition Stop command has been executed, the camera will not be able to acquire frames until a new Acquisition Start command is executed.

### **Frame Burst Start Trigger and the Trigger Mode**

The frame burst start trigger is essentially an enabler for the frame start trigger.

The Trigger Mode parameter with parameter values off and on has a direct bearing on how the Frame Burst Start Trigger works.

If the Trigger Mode parameter for the frame burst start trigger is set to off, the camera will generate all required frame burst start trigger signals internally, and you do not need to apply frame burst start trigger signals to the camera.

If the Trigger Mode parameter for the frame burst start trigger is set to on, the initial acquisition status of the camera will be "waiting for frame burst start trigger" (see Figure 53 on [page 115](#)). When the camera is in this acquisition status, it cannot react to frame start trigger signals. When a frame burst start trigger signal is applied to the camera, the camera will exit the "waiting for frame burst start trigger" acquisition status and enter a "waiting for frame start trigger" acquisition status. The camera can then react to frame start trigger signals. The camera will continue to react to frame start trigger signals until the number of frame start trigger signals it has received is equal to an integer parameter setting called the Acquisition Burst Frame Count. At that point, the camera will return to the "waiting for frame burst start trigger" acquisition status and will remain in that status until a new frame burst start trigger signal is applied.

As an example, assume that the Trigger Mode parameter is set to on, the Acquisition Burst Frame Count parameter is set to three, and the camera is in a "waiting for frame burst start trigger" acquisition status. When a frame burst start trigger signal is applied to the camera, it will exit the "waiting for frame burst start trigger" acquisition status and enter the "waiting for frame start trigger" acquisition status. Once the camera has received three frame start trigger signals, it will return to the "waiting for frame burst start trigger" acquisition status. At that point, you must apply a new frame burst start trigger signal to the camera to make it exit "waiting for frame burst start trigger".

### **Frame Start Trigger and the Trigger Mode**

Assuming that a frame burst start trigger signal has just been applied to the camera, the camera will exit from the "waiting for frame burst start trigger" acquisition status and enter a "waiting for frame start trigger" acquisition status. Applying a frame start trigger signal to the camera at this point will exit the camera from the "waiting for frame start trigger" acquisition status and will begin the process of exposing and reading out a frame (see Figure 53 on [page 115](#)). As soon as the camera is ready to accept another frame start trigger signal, it will return to the "waiting for frame start trigger" acquisition status. A new frame start trigger signal can then be applied to the camera to begin another frame exposure.

The Trigger Mode parameter with parameter values off and on has a direct bearing on how the Frame Start Trigger works.

If the Trigger Mode parameter for the frame start trigger is set to off, the camera will generate all required frame start trigger signals internally, and you do not need to apply frame start trigger signals to the camera. The rate at which the camera will generate the signals and acquire frames will be determined by the way that you set several frame rate related parameters.

If the Trigger Mode parameter for the frame start trigger is set to on, you must trigger frame start by applying frame start trigger signals to the camera. Each time a trigger signal is applied, the camera will begin a frame exposure. When frame start is being triggered in this manner, it is important that you do not attempt to trigger frames at a rate that is greater than the maximum allowed. (There is a detailed explanation about the maximum allowed frame rate in Section 6.10 on [page 184](#).) Frame start trigger signals applied to the camera when it is not in a "waiting for frame start trigger" acquisition status will be ignored.

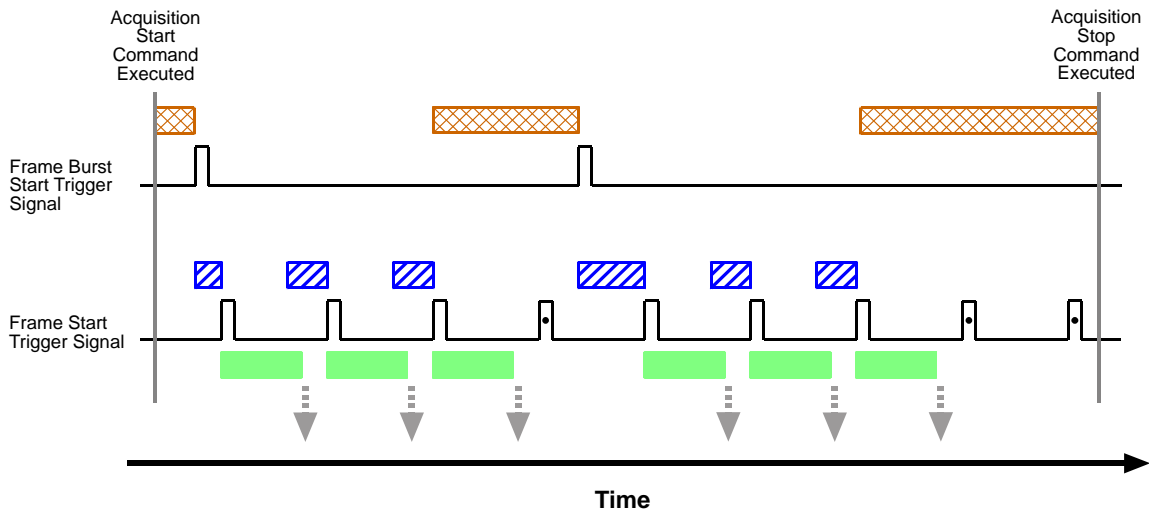
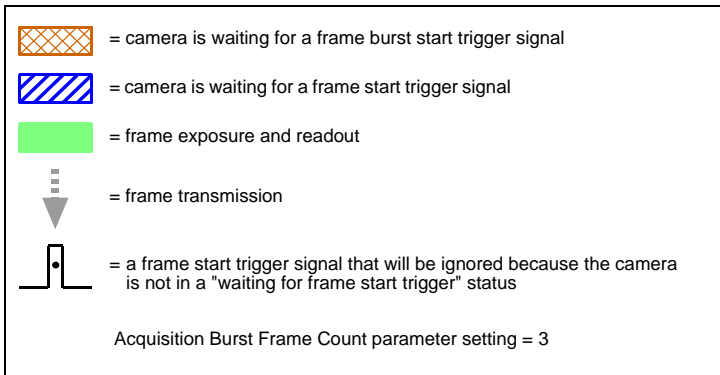

Fig. 53: Frame Burst Start and Frame Start Triggering

## Applying Trigger Signals

The paragraphs above mention "applying a trigger signal". There are two ways to apply a frame burst start or a frame start trigger signal to the camera: via software or via hardware.

To apply trigger signals via software, you must first select the acquisition start or the frame start trigger and then indicate that software will be used as the source for the selected trigger signal. At that point, each time a Trigger Software command is executed, the selected trigger signal will be applied to the camera.

To apply trigger signals via hardware, you must first select the frame burst start or the frame start trigger and indicate that input line 1 or Line 3 or 4 if configured for input will be used as the source for the selected trigger signal. At that point, each time a proper electrical signal is applied to the selected input line, an occurrence of the selected trigger signal will be recognized by the camera.

## The Trigger Selector

The concept of the "trigger selector" is very important to understand when working with the acquisition start and frame start triggers. Many of the parameter settings and the commands that apply to the triggers have names that are not specific to a particular type of trigger, for example, the frame burst start trigger has a mode setting and the frame start trigger has a mode setting. But in Basler pylon there is a single parameter, the Trigger Mode parameter, that is used to set the mode for both of these triggers. Also, the Trigger Software command mentioned earlier can be executed for either the frame burst start trigger or the frame start trigger. So if you want to set the Trigger Mode or execute a Trigger Software command for the frame burst start trigger rather than the frame start trigger, how do you do it? The answer is, by using the Trigger Selector parameter. Whenever you want to work with a specific type of trigger, your first step is to set the Trigger Selector parameter to the trigger you want to work with (either the frame burst start trigger or the frame start trigger). At that point, the changes you make to the Trigger Mode, Trigger Source, etc., will be applied to the selected trigger only.

## Exposure Time Control

As mentioned earlier, when a frame start trigger signal is applied to the camera, the camera will begin to acquire a frame. A critical aspect of frame acquisition is how long the pixels in the camera's sensor will be exposed to light during the frame acquisition.

A parameter called ExposureTime will determine the exposure time for each frame in the following cases:

- When the camera is set for software frame start triggering
- When the camera is set for hardware frame start triggering and for the "timed" exposure mode
- When the camera is triggered internally ("free run") which is enabled when the camera's Trigger Mode is set to "Off".

For hardware frame start triggering there is - for most camera models - the exposure mode available with two settings, "timed" and "trigger width".

- With the "timed" exposure mode, the ExposureTime parameter will determine the exposure time for each frame.
- With the "trigger width" exposure mode, the way that you manipulate the rise and fall of the hardware signal will determine the exposure time. The "trigger width" exposure mode is especially useful, if you want to change the exposure time from frame to frame.



Trigger width exposure mode is **not** available on acA1920-25um/uc, acA2500-14um/uc, acA3800-14um/uc, and acA4600-10um/uc cameras.

## 6.2 Acquisition Start and Stop Commands and the Acquisition Mode

Executing an Acquisition Start command prepares the camera to acquire frames. You must execute an Acquisition Start command before you can begin acquiring frames.

Executing an Acquisition Stop command terminates the camera's ability to acquire frames. When the camera receives an Acquisition stop command:

- If the camera is not in the process of acquiring a frame, its ability to acquire frames will be terminated immediately.
- If the camera is in the process of acquiring a frame, the frame acquisition process will be allowed to finish and the camera's ability to acquire new frames will be terminated.

The camera's Acquisition Mode parameter has two settings: Single Frame and Continuous. The use of Acquisition Start and Acquisition Stop commands and the camera's Acquisition Mode parameter setting are related.

If the camera's Acquisition Mode parameter is set to Single Frame, after an Acquisition Start command has been executed, a single frame can be acquired. When acquisition of one frame is complete, the camera will execute an Acquisition Stop command internally and will no longer be able to acquire frames. To acquire another frame, you must execute a new Acquisition Start command.

If the camera's Acquisition Mode parameter is set to Continuous, after an Acquisition Start command has been executed, frame acquisition can be triggered as desired. Each time a frame trigger is applied while the camera is in a "waiting for frame trigger" acquisition status, the camera will acquire and transmit a frame. The camera will retain the ability to acquire frames until an Acquisition Stop command is executed. Once the Acquisition Stop command is received, the camera will no longer be able to acquire frames.



When the camera's acquisition mode is set to Single Frame, the maximum possible acquisition frame rate for a given ROI cannot be achieved. This is true because the camera performs a complete internal setup cycle for each single frame and because it cannot be operated with "overlapped" acquisition.

To achieve the maximum possible acquisition frame rate, set the acquisition mode to Continuous and use "overlapped" acquisition. If available, also use the fast sensor readout mode and acquire images with default resolution.

For more information about overlapped acquisition, see Section 6.4.3.2 on [page 136](#), about the fast sensor readout mode see Section 6.6.1.1 on [page 150](#), and about default resolution, see Section 1.2 on [page 2](#).

## Setting the Acquisition Mode and Issuing Start/Stop Commands

You can set the Acquisition Mode parameter value and you can execute Acquisition Start or Acquisition Stop commands from within your application software by using the Basler pylon API. The code snippet below illustrates using the API to set the Acquisition Mode parameter value and to execute an Acquisition Start command, where Line 1 is taken as an example. Note that the snippet also illustrates setting several parameters regarding frame triggering. These parameters are discussed later in this chapter.

```
camera.AcquisitionMode.SetValue( AcquisitionMode_SingleFrame );
camera.TriggerSelector.SetValue( TriggerSelector_FrameStart );
camera.TriggerMode.SetValue( TriggerMode_On );
camera.TriggerSource.SetValue ( TriggerSource_Line1 );
camera.TriggerActivation.SetValue( TriggerActivation_RisingEdge );
camera.ExposureMode.SetValue( ExposureMode_Timed );
camera.ExposureTime.SetValue( 3000.0 );
camera.AcquisitionStart.Execute( );
```

You can also use the Basler pylon Viewer application to easily set the parameters.

For more information about the pylon API and the pylon Viewer, see Section 3.1 on [page 62](#).



## 6.3 The Frame Burst Start Trigger

(When reading this section, it is helpful to refer to Figure 53 on [page 115](#).)

The frame burst start trigger is used in conjunction with the frame start trigger to control the acquisition of frames. In essence, the frame burst start trigger is used as an enabler for the frame start trigger. Frame burst start trigger signals can be generated within the camera or may be applied externally as software or hardware frame burst start trigger signals.

When the frame burst start trigger is enabled, the camera's initial acquisition status is "waiting for frame burst start trigger". When the camera is in this acquisition status, it will ignore any frame start trigger signals it receives. If a frame burst start trigger signal is applied to the camera, it will exit the "waiting for frame burst start trigger" acquisition status and enter the "waiting for frame start trigger" acquisition status. In this acquisition status, the camera can react to frame start trigger signals and will begin to expose a frame each time a proper frame start trigger signal is applied.

A primary feature of the frame burst start trigger is that after a frame burst start trigger signal has been applied to the camera and the camera has entered the "waiting for frame start trigger" acquisition status, the camera will return to the "waiting for frame burst start trigger" acquisition status once a specified number of frame start triggers has been received. Before more frames can be acquired, a new frame burst start trigger signal must be applied to the camera to exit it from "waiting for frame burst start trigger" status. Note that this feature only applies when the Trigger Mode parameter for the frame burst start trigger is set to on. This feature is explained in greater detail in the following sections.

### 6.3.1 Frame Burst Start Trigger Mode

The main parameter associated with the frame burst start trigger is the Trigger Mode parameter. The Trigger Mode parameter for the frame burst start trigger has two available settings: off and on.

#### 6.3.1.1 Frame Burst Start Trigger Mode = Off

When the Trigger Mode parameter for the frame burst start trigger is set to off, the camera will generate all required frame burst start trigger signals internally, and you do not need to apply frame burst start trigger signals to the camera.

#### 6.3.1.2 Frame Burst Start Trigger Mode = On

When the Trigger Mode parameter for the frame burst start trigger is set to on, the camera will initially be in a "waiting for frame burst start trigger" acquisition status and cannot react to frame start trigger signals. You must apply a frame burst start trigger signal to the camera to exit the camera from the "waiting for frame burst start trigger" acquisition status and enter the "waiting for frame start trigger" acquisition status. The camera can then react to frame start trigger signals and will continue to do so until the number of frame start trigger signals it has received is equal to the current

Acquisition Burst Frame Count parameter setting. The camera will then return to the "waiting for frame burst start trigger" acquisition status. In order to acquire more frames, you must apply a new frame burst start trigger signal to the camera to exit it from the "waiting for frame burst start trigger" acquisition status.

When the Trigger Mode parameter for the frame burst start trigger is set to on, you must select a source signal to serve as the frame burst start trigger. The Trigger Source parameter specifies the source signal. The available selections for the Trigger Source parameter are:

- Software – When the source signal is set to software, you apply a frame burst start trigger signal to the camera by executing a Trigger Software command for the frame burst start trigger on the host computer.
- Software Signal 1, Software Signal 2, Software Signal 3 (the latter is not available on acA1920-155, acA2040-55, acA2040-120, acA2440-35, and acA2440-75 cameras) – Specific software commands, analogous to the Software command.
- Line 1 – When the source signal is set to Line 1, you apply a frame burst start trigger signal to the camera by injecting an externally generated electrical signal (commonly referred to as a hardware trigger signal) into physical input line Line 1 on the camera.
- Line 3 – Analogous to the Line 1 source signal. However, the Line 3 is a GPIO line and must be configured for input.
- Line 4 – Analogous to the Line 3 source signal.

If the Trigger Source parameter for the frame burst start trigger is set to Line 1, Line 3 or Line 4 you must also set the Trigger Activation parameter. The available settings for the Trigger Activation parameter are:

- Rising Edge - specifies that a rising edge of the electrical signal will act as the frame burst start trigger.
- Falling Edge - specifies that a falling edge of the electrical signal will act as the frame burst start trigger.



**When the Trigger Mode parameter for the frame burst start trigger is set to on, the camera's Acquisition Mode parameter must be set to Continuous.**

## 6.3.2 Acquisition Burst Frame Count

When the Trigger Mode parameter for the frame burst start trigger is set to on, you must set the value of the camera's Acquisition Burst Frame Count parameter. The value of the Acquisition Frame Count can range from 1 to 255.

With frame burst start triggering on, the camera will initially be in a "waiting for frame burst start trigger" acquisition status. When in this acquisition status, the camera cannot react to frame start trigger signals. If a frame burst start trigger signal is applied to the camera, the camera will exit the "waiting for frame burst start trigger" acquisition status and will enter the "waiting for frame start trigger" acquisition status. It can then react to frame start trigger signals. When the camera has received a number of frame start trigger signals equal to the current Acquisition Burst Frame Count parameter setting, it will return to the "waiting for frame burst start trigger" acquisition status. At that point, you must apply a new frame burst start trigger signal to exit the camera from the "waiting for frame burst start trigger" acquisition status.

### 6.3.3 Setting the Frame Burst Start Trigger Mode and Related Parameters

You can set the Trigger Mode and Trigger Source parameters for the frame burst start trigger and also set the Acquisition Burst Frame Count parameter value from within your application software by using the Basler pylon API.

The following code snippet illustrates using the API to set the Trigger Mode to on, the Trigger Source to software, and the Acquisition Burst Frame Count to 5:

```
// Set the acquisition mode to Continuous (the acquisition mode must
// be set to Continuous when frame burst start triggering is on)
camera.AcquisitionMode.SetValue( AcquisitionMode_Continuous );

// Select the frame burst start trigger
camera.TriggerSelector.SetValue(TriggerSelector_FrameBurstStart);
// Set the mode for the selected trigger
camera.TriggerMode.SetValue( TriggerMode_On );
// Set the source for the selected trigger
camera.TriggerSource.SetValue ( TriggerSource_Software );
// Set the acquisition burst frame count
camera.AcquisitionBurstFrameCount.SetValue( 5 );
```

The following code snippet illustrates using the API to set the Trigger Mode to on, the Trigger Source to Line 1, the Trigger Activation to rising edge, and the Acquisition Burst Frame Count to 5:

```
// Set the acquisition mode to Continuous (the acquisition mode must
// be set to Continuous when frame burst start triggering is on)
camera.AcquisitionMode.SetValue( AcquisitionMode_Continuous );
// Select the frame burst start trigger
camera.TriggerSelector.SetValue(TriggerSelector_FrameBurstStart);
// Set the mode for the selected trigger
camera.TriggerMode.SetValue( TriggerMode_On );
// Set the source for the selected trigger
camera.TriggerSource.SetValue ( TriggerSource_Line1 );
// Set the activation mode for the selected trigger to rising edge
camera.TriggerActivation.SetValue( TriggerActivation_RisingEdge );
// Set the acquisition burst frame count
camera.AcquisitionBurstFrameCount.SetValue( 5 );
```

You can also use the Basler pylon Viewer application to easily set the parameters.

For more information about the pylon API and the pylon Viewer, see Section 3.1 on [page 62](#).

## 6.3.4 Using a Software Frame Burst Start Trigger

### 6.3.4.1 Introduction

If the camera's Frame Burst Start Trigger Mode parameter is set to on and the Frame Burst Start Trigger Source parameter is set to software, you must apply a software frame burst start trigger signal to the camera before you can begin frame acquisition.

A software frame burst start trigger signal is applied by:

- Setting the Trigger Selector parameter to Acquisition Start.
- Executing a Trigger Software command.

The camera will initially be in a "waiting for frame burst start trigger" acquisition status. It cannot react to frame trigger signals when in this acquisition status. When a software frame burst start trigger signal is received by the camera, it will exit the "waiting for frame burst start trigger" acquisition status and will enter the "waiting for frame start trigger" acquisition status. It can then react to frame start trigger signals. When the number of frame start trigger signals received by the camera is equal to the current Acquisition Burst Frame Count parameter setting, the camera will return to the "waiting for frame burst start trigger" acquisition status. When a new software frame burst start trigger signal is applied to the camera, it will again exit from the "waiting for frame burst start trigger" acquisition status and enter the "waiting for frame start trigger" acquisition status.

(Note that as long as the Trigger Selector parameter is set to Frame Burst Start, a software frame burst start trigger will be applied to the camera each time a Trigger Software command is executed.)

### 6.3.4.2 Setting the Parameters Related to Software Frame Burst Start Triggering and Applying a Software Trigger Signal

You can set all of the parameters needed to perform software frame burst start triggering from within your application software by using the Basler pylon API. The following code snippet illustrates using the API to set the parameter values and to execute the commands related to software frame burst start triggering with the camera set for continuous acquisition mode:

```
// Set the acquisition mode to Continuous (the acquisition mode must
// be set to Continuous when frame burst start triggering is on)
camera.AcquisitionMode.SetValue( AcquisitionMode_Continuous );

// Select the frame burst start trigger
camera.TriggerSelector.SetValue(TriggerSelector_FrameBurstStart);
// Set the mode for the selected trigger
camera.TriggerMode.SetValue( TriggerMode_On );
// Set the source for the selected trigger
camera.TriggerSource.SetValue ( TriggerSource_Software );
// Set the acquisition burst frame count
camera.AcquisitionBurstFrameCount.SetValue( 5 );
// Execute an acquisition start command to prepare for frame acquisition
camera.AcquisitionStart.Execute( );
    while ( ! finished )
    {
        // Execute a trigger software command to apply a software acquisition
        // start trigger signal to the camera
        camera.TriggerSoftware.Execute( );

        // Perform the required functions to parameterize the frame start
        // trigger, to trigger 5 frame starts, and to retrieve 5 frames here
    }
camera.AcquisitionStop.Execute( );

// Note: as long as the Trigger Selector is set to Frame Burst Start, executing
// a Trigger Software command will apply a software frame burst start trigger
// signal to the camera
```

You can also use the Basler pylon Viewer application to easily set the parameters.

For more information about the pylon API and the pylon Viewer, see Section 3.1 on [page 62](#).

## 6.3.5 Using a Hardware Frame Burst Start Trigger

### 6.3.5.1 Introduction

If the Trigger Mode parameter for the frame burst start trigger is set to on and the Trigger Source parameter is, for example, set to Line 1, an externally generated electrical signal injected into physical input line Line 1 on the camera will act as the frame burst start trigger signal for the camera. This type of trigger signal is generally referred to as a hardware trigger signal or as an external frame burst start trigger signal (ExFBTrig).

A rising edge or a falling edge of the ExFBTrig signal can be used to trigger frame burst start. The Trigger Activation parameter is used to select rising edge or falling edge triggering.

When the Trigger Mode parameter is set to on, the camera will initially be in a "waiting for frame burst start trigger" acquisition status. It cannot react to frame start trigger signals when in this acquisition status. When the appropriate ExFBTrig signal is applied to Line 1 (e.g, a rising edge of the signal for rising edge triggering), the camera will exit the "waiting for frame burst start trigger" acquisition status and will enter the "waiting for frame start trigger" acquisition status. It can then react to frame start trigger signals. When the number of frame start trigger signals received by the camera is equal to the current Acquisition Burst Frame Count parameter setting, the camera will return to the "waiting for frame burst start trigger" acquisition status. When a new ExFBTrig signal is applied to Line 1, the camera will again exit from the "waiting for frame burst start trigger" acquisition status and enter the "waiting for frame start trigger" acquisition status.

For more information about setting the camera for hardware frame burst start triggering and selecting the input line to receive the ExFBTrig signal, see Section 6.3.5.2.

For more information about the electrical characteristics of Line 1, see Section 5.7.1 on [page 74](#), and of GPIO Line 3 and Line 4, set for input, see Section 5.9.3.1 on [page 82](#).

### 6.3.5.2 Setting the Parameters Related to Hardware Frame Burst Start Triggering and Applying a Hardware Trigger Signal

You can set all of the parameters needed to perform hardware frame burst start triggering from within your application by using the Basler pylon API. The following code snippet illustrates using the API to set the parameter values required to enable rising edge hardware frame burst start triggering with, for example, Line 1 as the trigger source:

```
// Set the acquisition mode to Continuous (the acquisition mode must
// be set to Continuous when frame burst start triggering is on)
camera.AcquisitionMode.SetValue( AcquisitionMode_Continuous );
// Select the frame burst start trigger
camera.TriggerSelector.SetValue( TriggerSelector_FrameBurstStart );
// Set the mode for the selected trigger
camera.TriggerMode.SetValue( TriggerMode_On );
// Set the source for the selected trigger
camera.TriggerSource.SetValue ( TriggerSource_Line1 );
// Set the activation mode for the selected trigger to rising edge
camera.TriggerActivation.SetValue( TriggerActivation_RisingEdge );
// Set the acquisition burst frame count
camera.AcquisitionBurstFrameCount.SetValue( 5 );
// Execute an acquisition start command to prepare for frame acquisition
camera.AcquisitionStart.Execute( );
    while ( ! finished )
    {
        // Apply a rising edge of the externally generated electrical signal
        // (ExFBTrig signal) to input line Line 1 on the camera

        // Perform the required functions to parameterize the frame start
        // trigger, to trigger 5 frame starts, and to retrieve 5 frames here
    }
camera.AcquisitionStop.Execute( );
```

You can also use the Basler pylon Viewer application to easily set the parameters.

For more information about the pylon API and the pylon Viewer, see Section 3.1 on [page 62](#).



## 6.4 The Frame Start Trigger

The frame start trigger is used to begin frame acquisition. Assuming that the camera is in a "waiting for frame start trigger" acquisition status, it will begin a frame acquisition each time it receives a frame start trigger signal.

Note that in order for the camera to be in a "waiting for frame start trigger" acquisition status:

- The Acquisition Mode parameter must be set correctly.
- A proper Acquisition Start command must be applied to the camera.
- A proper frame burst start trigger signal must be applied to the camera (if the Trigger Mode parameter for the frame burst start trigger is set to on).

For more information about the Acquisition Mode parameter and about Acquisition Start and Acquisition Stop commands, see Section 6.1 on [page 113](#) and Section 6.2 on [page 118](#).

For more information about the frame burst start trigger, and about the acquisition status, see Section 6.1 on [page 113](#) and Section 6.3 on [page 120](#).

Referring to the use case diagrams that appear in Section 6.9 on [page 180](#) can help you understand the explanations of the frame start trigger.

## 6.4.1 Frame Start Trigger Mode

The main parameter associated with the frame start trigger is the Trigger Mode parameter. The Trigger Mode parameter for the frame start trigger has two available settings: off and on.

### 6.4.1.1 Frame Start Trigger Mode = Off

When the Frame Start Trigger Mode parameter is set to off, the camera will generate all required frame start trigger signals internally, and you do not need to apply frame start trigger signals to the camera.

With the trigger mode set to off, the way that the camera will operate the frame start trigger depends on the setting of the camera's Acquisition Mode parameter:

- If the Acquisition Mode parameter is set to Single Frame, the camera will automatically generate a single frame start trigger signal whenever it receives an Acquisition Start command.
- If the Acquisition Mode parameter is set to Continuous, the camera will automatically begin generating frame start trigger signals when it receives an Acquisition Start command. The camera will continue to generate frame start trigger signals until it receives an Acquisition Stop command.

The rate at which the frame start trigger signals are generated can be determined by the camera's Acquisition Frame Rate parameter:

- If the parameter is not enabled, the camera will generate frame start trigger signals at the maximum rate allowed with the current camera settings.
- If the parameter is enabled and is set to a value less than the maximum allowed frame rate with the current camera settings, the camera will generate frame start trigger signals at the rate specified by the parameter setting.
- If the parameter is enabled and is set to a value greater than the maximum allowed frame rate with the current camera settings, the camera will generate frame start trigger signals at the maximum allowed frame rate.



Keep in mind that the camera will only react to frame start triggers when it is in a "waiting for frame start trigger" acquisition status. For more information about the acquisition status, see Section 6.1 on [page 113](#) and Section 6.3 on [page 120](#).

### Exposure Time Control with the Frame Start Trigger Off

When the Trigger Mode parameter for the frame start trigger is set to off, the exposure time for each frame acquisition is determined by the value of the camera's ExposureTime parameter.

For more information about the camera's ExposureTime parameter, see Section 6.5 on [page 145](#).

## 6.4.1.2 Frame Start Trigger Mode = On

When the Trigger Mode parameter for the frame start trigger is set to on, you must apply a frame start trigger signal to the camera each time you want to begin a frame acquisition. The Trigger Source parameter specifies the source signal that will act as the frame start trigger signal. The available selections for the Trigger Source parameter are:

- Software - When the source signal is set to software, you apply a frame start trigger signal to the camera by executing a Trigger Software command for the frame start trigger on the host computer.
- Software Signal 1, Software Signal 2, Software Signal 3 (the latter is not available on acA1920-155, acA2040-55, acA2040-120, acA2440-35, and acA2440-75 cameras) – Specific software commands, analogous to the Software command.
- Line 1 – When the source signal is set to Line 1, you apply a frame start trigger signal to the camera by injecting an externally generated electrical signal (commonly referred to as a hardware trigger signal) into physical input line Line 1 on the camera.
- Line 3 – Analogous to the Line 1 source signal. However, the GPIO line Line 3 must be configured for input.
- Line 4 – Analogous to the Line 3 source signal.

If the Trigger Source parameter is set to Line 1, Line 3 or Line 4 you must also set the Trigger Activation parameter. The available settings for the Trigger Activation parameter are:

- Rising Edge – specifies that a rising edge of the electrical signal will act as the frame start trigger.
- Falling Edge – specifies that a falling edge of the electrical signal will act as the frame start trigger.

For more information about using a software trigger to control frame acquisition start, see Section 6.4.2 on [page 133](#).

For more information about using a hardware trigger to control frame acquisition start, see Section 6.4.3 on [page 135](#).



By default, input line Line 1 is selected as the source signal for the frame start trigger.

Keep in mind that the camera will only react to frame start trigger signals when it is in a "waiting for frame start trigger" acquisition status. For more information about the acquisition status, see Section 6.1 on [page 113](#) and Section 6.3 on [page 120](#).

## Exposure Time Control with the Frame Start Trigger On

When the Trigger Mode parameter for the frame start trigger is set to on and the Trigger Source parameter is set to software, the exposure time for each frame acquisition is determined by the value of the camera's ExposureTime parameter.

When the Trigger Mode parameter is set to on and the Trigger Source parameter is set to input line Line 1, the exposure time for each frame acquisition can be controlled with the ExposureTime parameter or it can be controlled by manipulating the hardware trigger signal.

For more information about controlling exposure time when using a software trigger, see Section 6.4.2 on [page 133](#).

For more information about controlling exposure time when using a hardware trigger, see Section 6.4.3 on [page 135](#).

### 6.4.1.3 Setting The Frame Start Trigger Mode and Related Parameters

You can set the Trigger Mode and related parameter values for the frame start trigger from within your application software by using the Basler pylon API. If your settings make it necessary, you can also set the Trigger Source parameter.

The following code snippet illustrates using the API to set the Trigger Mode for the frame start trigger to on and the Trigger Source to input line Line 1:

```
// Select the frame start trigger
camera.TriggerSelector.SetValue(TriggerSelector_FrameStart);
// Set the trigger mode for the selected trigger
camera.TriggerMode.SetValue(TriggerMode_On);
// Set the source for the selected trigger
camera.TriggerSource.SetValue(TriggerSource_Line1);
```

The following code snippet illustrates using the API to set the Acquisition Mode to Continuous, the Trigger Mode to off, and the Acquisition Frame Rate to 60:

```
// Set the acquisition mode to Continuous
camera.AcquisitionMode.SetValue(AcquisitionMode_Continuous);
// Select the frame start trigger
camera.TriggerSelector.SetValue(TriggerSelector_FrameStart);
// Set the mode for the selected trigger
Camera.TriggerMode.SetValue( TriggerMode_Off );
// Set the exposure time
Camera.ExposureTime.SetValue( 3000.0 );
// Enable the acquisition frame rate parameter and set the frame rate. (Enabling
// the acquisition frame rate parameter allows the camera to control the frame
// rate internally.)
camera.AcquisitionFrameRateEnable.SetValue(true);
camera.AcquisitionFrameRate.SetValue(60.0);
```

```
// Start frame capture  
Camera.AcquisitionStart.Execute( );
```

You can also use the Basler pylon Viewer application to easily set the parameters.

For more information about the pylon API and the pylon Viewer, see Section 3.1 on [page 62](#).

## 6.4.2 Using a Software Frame Start Trigger

### 6.4.2.1 Introduction

If the Trigger Mode parameter for the frame start trigger is set to on and the Trigger Source parameter is set to software, you must apply a software frame start trigger signal to the camera to begin each frame acquisition. Assuming that the camera is in a "waiting for frame start trigger" acquisition status, frame exposure will start when the software frame start trigger signal is received by the camera. Figure 54 illustrates frame acquisition with a software frame start trigger signal.

When the camera receives a software trigger signal and begins exposure, it will exit the "waiting for frame start trigger" acquisition status because at that point, it cannot react to a new frame start trigger signal. As soon as the camera is capable of reacting to a new frame start trigger signal, it will automatically return to the "waiting for frame start trigger" acquisition status.

When you are using a software trigger signal to start each frame acquisition, the camera's Exposure Mode parameter must be set to timed. The exposure time for each acquired frame will be determined by the value of the camera's ExposureTime parameter.

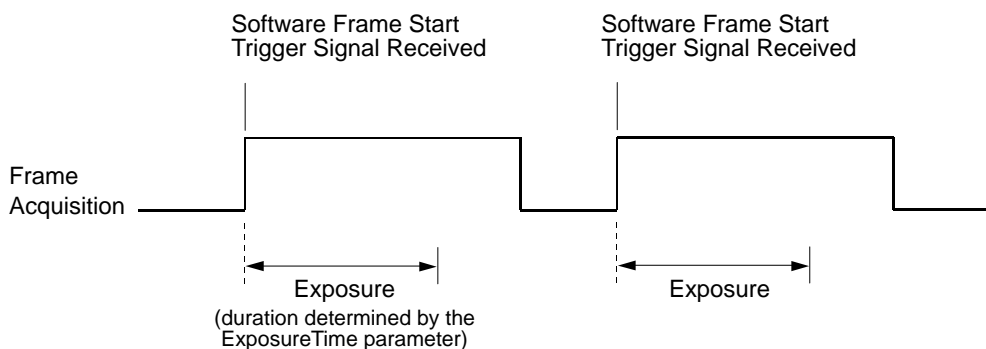

Fig. 54: Frame Acquisition with a Software Frame Start Trigger

When you are using a software trigger signal to start each frame acquisition, the frame rate will be determined by how often you apply a software trigger signal to the camera, and you should not attempt to trigger frame acquisition at a rate that exceeds the maximum allowed for the current camera settings. (There is a detailed explanation about the maximum allowed frame rate in Section 6.10 on [page 184](#)). Software frame start trigger signals that are applied to the camera when it is not ready to receive them will be ignored.

Section 6.4.2.2 on [page 134](#) includes more detailed information about applying a software frame start trigger signal to the camera using Basler pylon.

For more information about determining the maximum allowed frame rate, see Section 6.10 on [page 184](#).

## 6.4.2.2 Setting the Parameters Related to Software Frame Start Triggering and Applying a Software Trigger Signal

You can set all of the parameters needed to perform software frame start triggering from within your application software by using the Basler pylon API. The following code snippet illustrates using the API to set the parameter values and to execute the commands related to software frame start triggering with the camera set for continuous acquisition mode. In this example, the trigger mode for the frame burst start trigger will be set to off:

```
// Set the acquisition mode to Continuous
camera.AcquisitionMode.SetValue(AcquisitionMode_Continuous);
// Select the frame burst start trigger
camera.TriggerSelector.SetValue(TriggerSelector_FrameBurstStart);
// Set the mode for the selected trigger
camera.TriggerMode.SetValue(TriggerMode_Off);
// Disable the acquisition frame rate parameter (this will disable the camera's
// internal frame rate control and allow you to control the frame rate with
// software frame start trigger signals)
camera.AcquisitionFrameRateEnable.SetValue(false);
// Select the frame start trigger
camera.TriggerSelector.SetValue(TriggerSelector_FrameStart);
// Set the mode for the selected trigger
camera.TriggerMode.SetValue(TriggerMode_On);
// Set the source for the selected trigger
camera.TriggerSource.SetValue(TriggerSource_Software);
// Set for the timed exposure mode
camera.ExposureMode.SetValue(ExposureMode_Timed);
// Set the exposure time
camera.ExposureTime.SetValue(3000.0);
// Execute an acquisition start command to prepare for frame acquisition
camera.AcquisitionStart.Execute( );
    while ( ! finished )
    {
        // Execute a Trigger Software command to apply a frame start
        // trigger signal to the camera
        camera.TriggerSoftware.Execute( );
        // Retrieve acquired frame here
    }
camera.AcquisitionStop.Execute( );
// Note: as long as the Trigger Selector is set to FrameStart, executing
// a Trigger Software command will apply a software frame start trigger
// signal to the camera
```

You can also use the Basler pylon Viewer application to easily set the parameters.

For more information about the pylon API and the pylon Viewer, see Section 3.1 on [page 62](#).

## 6.4.3 Using a Hardware Frame Start Trigger

### 6.4.3.1 Introduction

If the Trigger Mode parameter for the frame start trigger is set to on and the Trigger Source parameter is set to Line 1, an externally generated electrical signal injected into physical input line Line 1 on the camera will act as the frame start trigger signal for the camera. This type of trigger signal is generally referred to as a hardware trigger signal or as an external frame start trigger signal (ExFSTrig).

A rising edge or a falling edge of the ExFSTrig signal can be used to trigger frame acquisition. The Trigger Activation parameter is used to select rising edge or falling edge triggering.

Assuming that the camera is in a "waiting for frame start trigger" acquisition status, frame acquisition will start whenever the appropriate edge transition is received by the camera.

When the camera receives a hardware trigger signal and begins exposure, it will exit the "waiting for frame start trigger" acquisition status because at that point, it cannot react to a new frame start trigger signal. As soon as the camera is capable of reacting to a new frame start trigger signal, it will automatically return to the "waiting for frame start trigger" acquisition status.

When the camera is operating under control of an ExFSTrig signal, the period of the ExFSTrig signal will determine the rate at which the camera is acquiring frames:

$$\frac{1}{\text{ExFSTrig period in seconds}} = \text{Frame Rate}$$

For example, if you are operating a camera with an ExFSTrig signal period of 20 ms (0.020 s):

$$\frac{1}{0.020} = 50 \text{ fps}$$

So in this case, the frame rate is 50 fps.



If you are triggering frame acquisition with an ExFSTrig signal and you attempt to acquire frames at too high a rate, some of the frame trigger signals that you apply will be received by the camera when it is not in a "waiting for frame start trigger" acquisition status. The camera will ignore any frame start trigger signals that it receives when it is not "waiting for frame start trigger". (This situation is commonly referred to as "over triggering" the camera.)

To avoid over triggering, you should not attempt to acquire frames at a rate that exceeds the maximum allowed with the current camera settings.

For more information about setting the camera for hardware frame start triggering and selecting the input line to receive the ExFSTrig signal, see Section 6.4.3.4 on [page 143](#).



For more information about the electrical characteristics of Line 1, see Section 5.7.1 on [page 74](#).

For more information about determining the maximum allowed frame rate, see Section 6.10 on [page 184](#).



### 6.4.3.2 Exposure Modes

If you are triggering the start of frame acquisition by a trigger signal generated externally via hardware (ExFSTrig), two exposure modes are available: timed and trigger width exposure.

|   |   |
|---|---|
|  | <p>Trigger width exposure mode is <b>not</b> available on acA1920-25um/uc, acA2500-14um/uc, acA3800-14um/uc, and acA4600-10um/uc cameras.</p> |
|  | <p>You must set TriggerMode and TriggerSource before setting ExposureMode. Otherwise, the set ExposureMode will not operate.</p>              |

#### Timed Exposure Mode

When timed exposure mode is selected, the exposure time for each frame acquisition is determined by the value of the camera's ExposureTime parameter. If the camera is set for rising edge triggering, the exposure time starts when the ExFSTrig signal rises. If the camera is set for falling edge triggering, the exposure time starts when the ExFSTrig signal falls. Figure 55 illustrates timed exposure with the camera set for rising edge triggering.

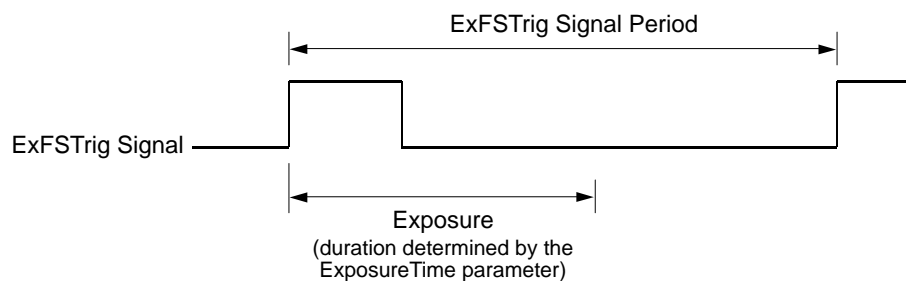

Fig. 55: Timed Exposure with Rising Edge Triggering

Note that, if you attempt to trigger a new exposure start while the previous exposure is still in progress, the trigger signal will be ignored, and a Frame Start Overtrigger event will be generated. This situation is illustrated in Figure 56 for rising edge triggering.

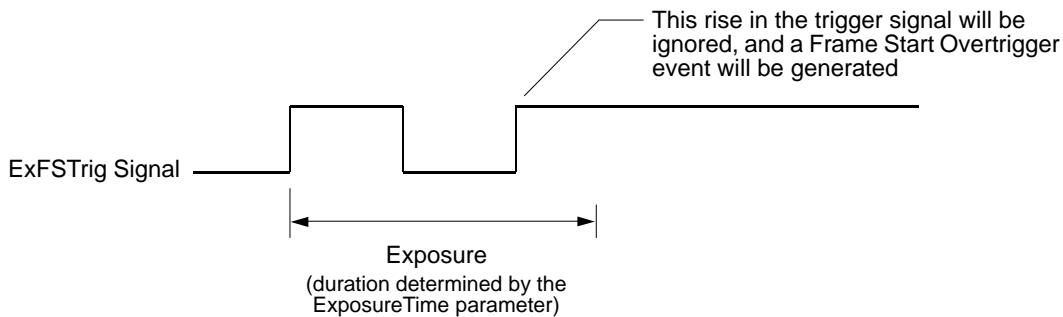

Fig. 56: Overtriggering with Timed Exposure

For more information about the Frame Start Overtrigger event, see Section 7.17 on [page 319](#).

For more information about the camera's ExposureTime parameter, see Section 6.5 on [page 145](#).

### Trigger Width Exposure Mode (acA640-90, acA640-120, acA1300-30, and acA1600-20)

When trigger width exposure mode is selected, the length of the exposure for each frame acquisition will be directly controlled by the ExFSTrig signal. If the camera is set for rising edge triggering, the exposure time begins when the ExFSTrig signal rises and continues until the ExFSTrig signal falls. If the camera is set for falling edge triggering, the exposure time begins when the ExFSTrig signal falls and continues until the ExFSTrig signal rises. Figure 57 illustrates trigger width exposure with the camera set for rising edge triggering.

Trigger width exposure is especially useful, if you intend to vary the length of the exposure time for each captured frame.

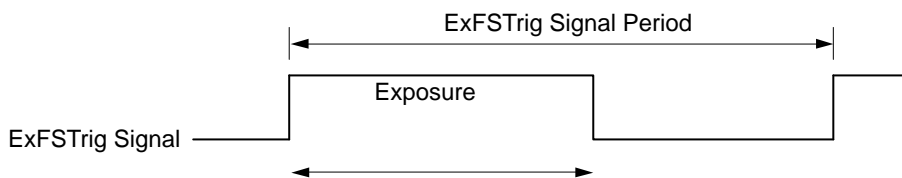

Fig. 57: Trigger Width Exposure with Rising Edge Triggering

To avoid overtriggering, use of the Frame Trigger Wait signal is strongly recommended. To use the Frame Trigger Wait signal, you must set the ExposureOverlapTimeMax parameter. Its parameter setting is used to operate the Frame Trigger Wait signal.

You should set the ExposureOverlapTimeMax parameter value to represent the shortest exposure time you intend to use. For example, assume that you will be using trigger width exposure mode

and that you intend to use the ExFSTrig signal to vary the exposure time in a range from 3000  $\mu$ s to 5500  $\mu$ s. In this case you would set the Exposure Overlap Time Max parameter to 3000  $\mu$ s.

For more information about the Frame Trigger Wait signal, see Section 6.8.4.2 on [page 174](#).

## Trigger Width Exposure Mode for Cameras with Exposure Time Offset

Trigger width exposure is especially useful if you intend to vary the length of the exposure time for each captured frame.

Some cameras provide an additional exposure time, the so-called exposure time offset ( $C_4$ ), that is automatically appended to the user-controlled exposure time.

The following cameras provide an exposure time offset: acA640-750, acA800-510, acA1300-200, acA1920-40, acA1920-150, acA1920-155um, acA2000-165, acA2040-55, acA2040-90, acA2040-120, acA2440-35, acA2440-75, acA2500-60.

Accordingly, when trigger width exposure mode is selected, the exposure time for each frame acquisition is the sum of two individual time periods (see [Figure 59](#)):

- The first time period is the exposure time that is controlled by the ExFSTrig signal: If the camera is set for rising edge triggering, the first time period - and therewith the exposure time - begins when the ExFSTrig signal rises. The first time period ends when the ExFSTrig signal falls.

If the camera is set for falling edge triggering, the first time period begins when the ExFSTrig signal falls. The first time period ends when the ExFSTrig signal rises.

- The second time period is the exposure time offset,  $C_4$ . It is automatically appended by the camera's sensor to the first time period. The length of the exposure time offset usually depends on the bit depth of the current pixel format (8 bit, 10 bit or 12 bit) and, for some camera models, on the currently available USB 3.0 bandwidth (expressed as "Device Link Throughput").

For exposure time offsets,  $C_4$ , and their dependencies, see [Table 32](#) and [Figure 58](#).

Note that  $C_4$  is generally smaller than the camera's **minimum** allowed exposure time. For the cameras' minimum allowed exposure times, see [Table 33](#) on [page 146](#) and [Table 34](#) on [page 147](#).

| Camera Model               | Pixel Format Bit Depth [bit] | Device Link Throughput [MByte/s] | Exposure Time Offset, C <sub>4</sub> [μs] |
|----------------------------|------------------------------|----------------------------------|---|
| acA640-750                 | 8                            | N/A                              | 32  |
| acA800-510                 |                              | N/A                              | 32  |
| acA1300-200                |                              | N/A                              | 32  |
| acA1920-40                 |                              | N/A                              | 15  |
| acA1920-150                |                              | N/A                              | 65  |
| acA1920-155                |                              | N/A                              | 15  |
| acA2000-165,<br>acA2040-90 |                              | ≤ 108.000                        | 42  |
|                            |                              | >108.000 to ≤ 140.000            | 32  |
|                            |                              | >140.000 to ≤ 160.020            | 28  |
|                            |                              | >160.020 to ≤ 180.000            | 25  |
|                            |                              | >180.000 to ≤ 192.112            | 24  |
|                            |                              | >192.112 to ≤ 216.000            | 42  |
|                            |                              | >216.000 to ≤ 280.000            | 32  |
|                            |                              | >280.000 to ≤ 320.040            | 28  |
|                            |                              | >320.040 to ≤ 360.000            | 25  |
|                            |                              | >360.000 to ≤ 384.224            | 24  |
| acA2040-55                 |                              | N/A                              | 15  |
| acA2040-120                |                              | N/A                              | 15  |
| acA2440-35                 |                              | N/A                              | 15  |
| acA2440-75                 | N/A                          | 15                               |   |
| acA2500-60                 | N/A                          | 37                               |   |
| acA640-750                 | 10                           | N/A                              | 32  |
| acA800-510                 |                              | N/A                              | 32  |
| acA1300-200                |                              | N/A                              | 32  |
| acA1920-150                |                              | N/A                              | 56.5                                      |
| acA2500-60                 |                              | N/A                              | 56.5                                      |
| acA1920-40                 | 12                           | N/A                              | 15  |
| acA1920-155                |                              | N/A                              | 15  |
| acA2000-165,<br>acA2040-90 |                              | All allowed values               | 28  |

Table 32: Exposure Time Offset, C<sub>4</sub>, Depending on Pixel Format Bit Depth and Device Link Throughput

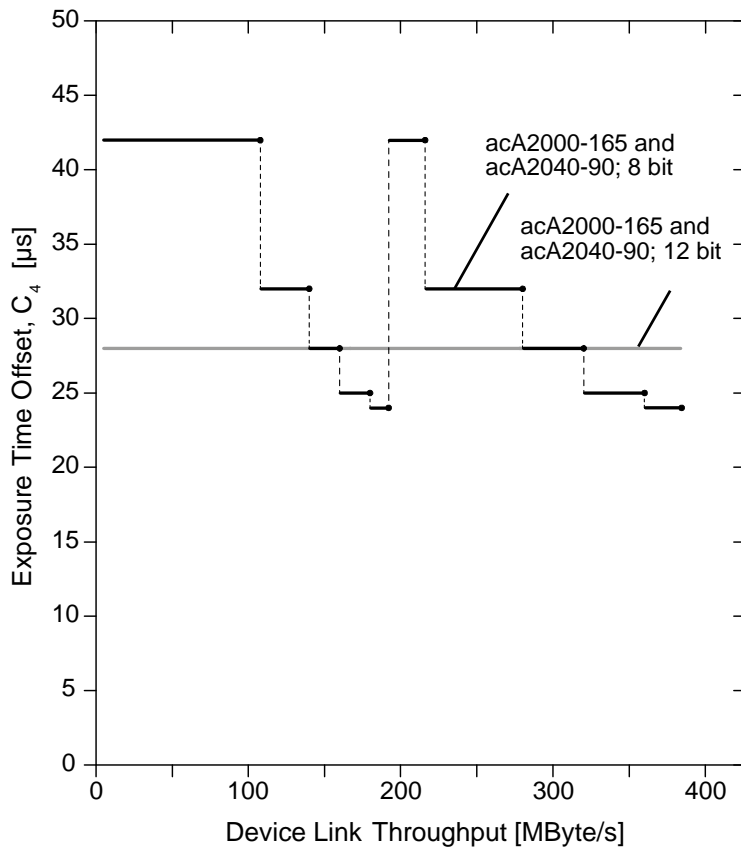

Fig. 58: Exposure Time Offsets Depending on Device Link Throughput (acA200-165u and acA2040-90u Cameras Only; All 8 bit- and 12 bit-Pixel Formats)

To obtain the wanted exposure time with trigger width exposure mode:

1. Subtract the value for  $C_4$  (see [Table 32](#) and [Figure 58](#)) that applies to your camera model, from the wanted exposure time.
2. Use the resulting time as the signal high time for the ExFSTrig signal if the signal is not inverted or as the low time if the signal is inverted.

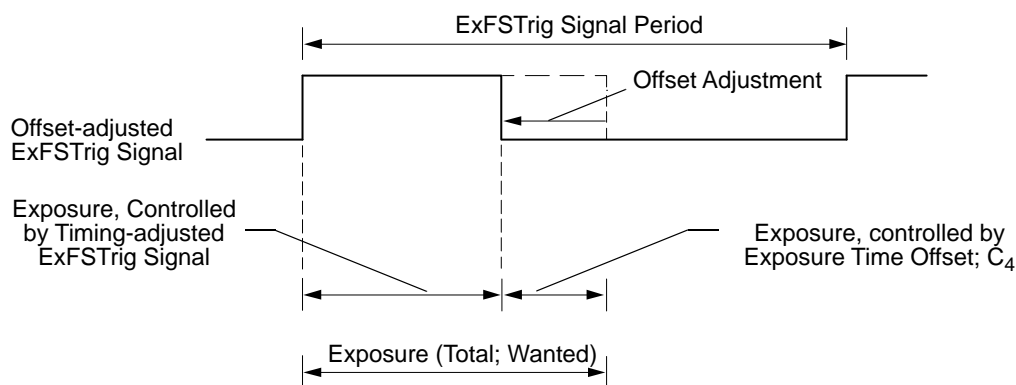

Fig. 59: Trigger Width Exposure with Adjusted Rising Edge Triggering; (Exposure Start Delay Is Omitted)

## Example

Let's assume you are operating an acA2000-165u camera at a device link throughput value of 250 MByte/s, the camera is set for rising edge triggering, and you want to use an exposure time of 100  $\mu$ s. Under these conditions 32  $\mu$ s of exposure time (see [Table 32](#)) will be added automatically to the exposure time that is controlled by the ExFSTrig signal.

To achieve the wanted exposure time of 100  $\mu$ s, you would therefore keep the ExFSTrig signal high for 68  $\mu$ s (= 100  $\mu$ s - 32  $\mu$ s). Subsequently, the camera would add automatically 32  $\mu$ s, giving a total of 100  $\mu$ s exposure time which is the wanted exposure time.



You will have to do offset adjustment of the ExFSTrig signal **only** if you use the trigger width exposure mode. In all other exposure modes (where the ExposureTime parameter controls exposure time), the camera automatically adjusts for the exposure time offset,  $C_4$ .

Note that the  $C_4$  exposure time offset does **not** affect the moment of exposure start.

## Parameters for Controlling Overlap

When you operate the camera in trigger width exposure mode, use of the Frame Trigger Wait signal is strongly recommended to avoid overtriggering. To use the Frame Trigger Wait signal, you must set the Exposure Overlap Time Max parameter. Its parameter setting is used to operate the Frame Trigger Wait signal.



For acA640-750, acA800-510, acA1300-200, acA1920-40, acA1920-150, acA1920-155, acA2040-55, acA2040-120, acA2440-35, acA2440-75, and acA2500-60 cameras, the Exposure Overlap Time Max parameter is used in the context of exposure overlap time modes. For more information, see the next section.

You can avoid overtriggering the camera by always doing the following:

- Setting the camera's Exposure Overlap Time Max parameter so that it represents the smallest exposure time you intend to use.
- Making sure that your exposure time is always equal to or greater than the setting for the Exposure Overlap Time Max parameter.
- Monitoring the camera's Frame Trigger Wait signal and only using the ExFSTrig signal to start exposure when the Frame Trigger Wait signal is high.

You should set the Exposure Overlap Time Max parameter value to represent the shortest exposure time you intend to use. For example, assume that you will be using trigger width exposure mode and that you intend to use the ExFSTrig signal to vary the exposure time in a range from 3000  $\mu$ s to 5500  $\mu$ s. In this case you would set the camera's Exposure Overlap Time Max parameter to 3000  $\mu$ s.

For more information about the Frame Trigger Wait signal, see Section 6.8.4.2 on [page 174](#).

You can use the Basler pylon API to set the Exposure Overlap Time Max parameter value from within your application software. The following code snippet illustrates using the API to set the parameter value:

```
camera.ExposureOverlapTimeMax.SetValue( 3000.0 );
```

You can also use the Basler pylon Viewer application to easily set the parameters.

For more information about the pylon API and the pylon Viewer, see Section 3.1 on [page 62](#).

## Particular Implementation for Cameras with Exposure Overlap Time Modes

For acA640-750, acA800-510, acA1300-200, acA1920-40, acA1920-150, acA1920-155, acA2040-55, acA2040-120, acA2440-35, acA2440-75, and acA2500-60 cameras, you can choose between Exposure Overlap Time Modes:

- If you set the Manual mode, use of the Frame Trigger Wait signal is strongly recommended to avoid overtriggering. To use the Frame Trigger Wait signal, you must set the Exposure Overlap Time Max parameter, described in the preceding section.
- If you set the Automatic mode, the camera will automatically use the maximum possible overlap time for each acquisition. The Automatic mode will be particularly useful with long exposure times. Note that the Frame Trigger Wait signal is not available when the Automatic mode is selected. The Automatic mode is the default mode.

You can use the Basler pylon API to set the Exposure Overlap Time Modes and the Exposure Overlap Time Max parameter value from within your application software. The following code snippet illustrates using the API to set the parameter values:

```
// Set (and read) the Manual mode for the ExposureOverlapTimeMode
// and set an ExposureOverlapTimeMax parameter value
camera.ExposureOverlapTimeMode.SetValue(ExposureOverlapTimeMode_Manual);
ExposureOverlapTimeModeEnums e = camera.ExposureOverlapTimeMode.GetValue();
// Set an ExposureOverlapTimeMax parameter value
camera.ExposureOverlapTimeMax.SetValue( 3000.0 );

// Set (and read) the Automatic mode for the ExposureOverlapTimeMode
camera.ExposureOverlapTimeMode.SetValue(ExposureOverlapTimeMode_Automatic);
ExposureOverlapTimeModeEnums e = camera.ExposureOverlapTimeMode.GetValue();
```

You can also use the Basler pylon Viewer application to easily set the parameters.

To avoid overtriggering, use of the Frame Trigger Wait signal is strongly recommended. To use the Frame Trigger Wait signal, you must set the camera's ExposureOverlapTimeMax parameter. This parameter setting is used to operate the Frame Trigger Wait signal.

For more information about the pylon API and the pylon Viewer, see Section 3.1 on [page 62](#).

### 6.4.3.3 Frame Start Trigger Delay

The frame start trigger delay feature lets you specify a delay (in microseconds) that is applied between the receipt of a hardware frame start trigger and when the trigger becomes effective.

The frame start trigger delay can be specified in the range from 0 to 1000000  $\mu$ s (equivalent to 1 s). When the delay is set to 0  $\mu$ s, no delay will be applied.

To set the frame start trigger delay:

- Set the camera's Trigger Selector parameter to frame start.
- Set the value of the Trigger Delay parameter.



The frame start trigger delay will not operate, if the Frame Start Trigger Mode parameter is set to off or if you are using a software frame start trigger.

### 6.4.3.4 Setting the Parameters Related to Hardware Frame Start Triggering and Applying a Hardware Trigger Signal

You can set all of the parameters needed to perform hardware frame start triggering from within your application by using the Basler pylon API. The following code snippet illustrates using the API to set the camera for single acquisition mode with the trigger mode for the frame burst start trigger set to off. We will use the timed exposure mode with input line Line 1 as the trigger source and with rising edge triggering. In this example, we will use a trigger delay:

```
// Set the acquisition mode to single frame
camera.AcquisitionMode.SetValue( AcquisitionMode_SingleFrame );
// Select the frame burst start trigger
camera.TriggerSelector.SetValue(TriggerSelector_FrameBurstStart);
// Set the mode for the selected trigger
camera.TriggerMode.SetValue( TriggerMode_Off );
// Select the frame start trigger
camera.TriggerSelector.SetValue( TriggerSelector_FrameStart );
// Set the mode for the selected trigger
camera.TriggerMode.SetValue( TriggerMode_On );
// Set the source for the selected trigger
camera.TriggerSource.SetValue ( TriggerSource_Line1 );
// Set the trigger activation mode to rising edge
camera.TriggerActivation.SetValue(TriggerActivation_RisingEdge);
// Set the trigger delay for one millisecond (1000us == 1ms == 0.001s)
camera.TriggerDelay.SetValue(1.78);
// Set for the timed exposure mode
camera.ExposureMode.SetValue(ExposureMode_Timed);
// Set the exposure time
camera.ExposureTime.SetValue(3000.0);
```



```

// Execute an acquisition start command to prepare for frame acquisition
camera.AcquisitionStart.Execute( );

// Frame acquisition will start when the externally generated
// frame start trigger signal (ExFSTrig signal) goes high

```

The following code snippet illustrates using the API to set the parameter values and execute the commands related to hardware frame start triggering with the camera set for continuous acquisition mode and the trigger mode for the frame burst start trigger set to off. We will use the trigger width exposure mode with input line Line 1 as the trigger source and with rising edge triggering:

```

// Set the acquisition mode to Continuous
camera.AcquisitionMode.SetValue(AcquisitionMode_Continuous);
// Select the frame burst start trigger
camera.TriggerSelector.SetValue(TriggerSelector_FrameBurstStart);
// Set the mode for the selected trigger
camera.TriggerMode.SetValue(TriggerMode_Off);
// Disable the acquisition frame rate parameter (this will disable the camera's
// internal frame rate control and allow you to control the frame rate with
// external frame start trigger signals)
camera.AcquisitionFrameRateEnable.SetValue(false);
// Select the frame start trigger
Camera.TriggerSelector.SetValue( TriggerSelector_FrameStart );
// Set the mode for the selected trigger
Camera.TriggerMode.SetValue( TriggerMode_On );
// Set the source for the selected trigger
camera.TriggerSource.SetValue ( TriggerSource_Line1 );
// Set the trigger activation mode to rising edge
camera.TriggerActivation.SetValue( TriggerActivation_RisingEdge );
// Set for the trigger width exposure mode
camera.ExposureMode.SetValue( ExposureMode_TriggerWidth );
// Set the exposure overlap time max- the shortest exposure time
// we plan to use is 1500 us
camera.ExposureOverlapTimeMax.SetValue( 1500 );
// Prepare for frame acquisition here
    camera.AcquisitionStart.Execute( );
    while ( ! finished )
    {
        // Frame acquisition will start each time the externally generated
        // frame start trigger signal (ExFSTrig signal) goes high

        // Retrieve the captured frames
    }
    camera.AcquisitionStop.Execute( );

```

You can also use the Basler pylon Viewer application to easily set the parameters.

For more information about the pylon API and pylon Viewer, see Section 3.1 on [page 62](#).

## 6.5 Setting the Exposure Time



This section describes how the exposure time can be adjusted "manually", i.e., by setting the value of the ExposureTime parameter.

The camera also has an Exposure Auto function that can automatically adjust the exposure time. **Manual adjustment of the ExposureTime parameter will only work correctly if the Exposure Auto function is disabled.**

For more information about auto functions in general, see Section 7.15 on [page 299](#).

For more information about the Exposure Auto function in particular, see Section 7.15.5 on [page 309](#).

## 6.5.1 Exposure Times for All Models Except the acA2000-165 and acA2040-90

The section presents the minimum and maximum parameter values for the ExposureTime parameter (Table 33). All camera models are included except the acA2000-165um/umNIR/uc and acA2040-90um/umNIR/uc cameras that are considered in Section 6.5.2.

| Camera Model     | Exposure Times [ $\mu$ s] |        |                  |           |
|------------------|---------------------------|--------|------------------|-----------|
|                  | Minimum Allowed           |        | Maximum Possible | Increment |
|                  | 8 bit                     | 12 bit |                  |           |
| acA640-90um/uc   | 17                        |        | 10000000         | 1         |
| acA640-120um/uc  | 4                         |        | 10000000         | 1         |
| acA640-750um/uc  | 59                        |        | 1000000          | 1         |
| acA800-510um/uc  | 59                        |        | 1000000          | 1         |
| acA1300-30um/uc  | 16                        |        | 10000000         | 1         |
| acA1300-200um/uc | 59                        |        | 1000000          | 1         |
| acA1600-20um/uc  | 25                        |        | 10000000         | 1         |
| acA1920-25um/uc  | 35                        |        | 9999990          | 35        |
| acA1920-40um/uc  | 34                        | 40     | 10000000         | 1         |
| acA1920-150um/uc | 105                       |        | 1000000          | 1         |
| acA1920-155um/uc | 20                        | 21     | 10000000         | 1         |
| acA2040-55um/uc  | 27                        |        | 10000000         | 1         |
| acA2040-120um/uc | 20                        | 21     | 10000000         | 1         |
| acA2440-35um/uc  | 29                        |        | 10000000         | 1         |
| acA2440-75um/uc  | 21                        | 22     | 10000000         | 1         |
| acA2500-14um/uc  | 35                        |        | 9999990          | 35        |
| acA2500-60um/uc  | 81                        |        | 100000           | 1         |
| acA3800-14um/uc  | 35                        |        | 1600000          | 1         |
| acA4600-10uc     | 35                        |        | 1460000          | 1         |

Table 33: Minimum Allowed Exposure Time Settings for All Pixel Format Bit Depths Unless Indicated Otherwise, Maximum Possible Exposure Time Settings and Increments.

## 6.5.2 Exposure Times for the acA2000-165 and acA2040-90

The section presents the minimum allowed and maximum possible parameter values for the ExposureTime parameter (Table 34) for acA2000-165um/umNIR/uc and acA2040-90um/umNIR/uc cameras. The other camera models are considered in Section 6.5.1.

The minimum allowed exposure times depend on the bit depth of the current pixel format and on the currently available USB 3.0 bandwidth (see Table 34 and Figure 58).

| Camera Model                                      | Pixel Format Bit Depth [bit] | Device Link Throughput [MByte/s] | Exposure Time [ $\mu$ s] |                  |           |
|---|------------------------------|----------------------------------|--------------------------|------------------|-----------|
|   |                              |                                  | Minimum Allowed          | Maximum Possible | Increment |
| acA2000-165um/umNIR/uc, and acA2040-90um/umNIR/uc | 8                            | $\leq 108.000$                   | 42                       | 10000000         | 1         |
|   |                              | $>108.000$ to $\leq 140.000$     | 32                       |                  |           |
|   |                              | $>140.000$ to $\leq 160.020$     | 28                       |                  |           |
|   |                              | $>160.020$ to $\leq 180.000$     | 25                       |                  |           |
|   |                              | $>180.000$ to $\leq 192.112$     | 24                       |                  |           |
|   |                              | $>192.112$ to $\leq 216.000$     | 42                       |                  |           |
|   |                              | $>216.000$ to $\leq 280.000$     | 32                       |                  |           |
|   |                              | $>280.000$ to $\leq 320.040$     | 28                       |                  |           |
|   |                              | $>320.040$ to $\leq 360.000$     | 25                       |                  |           |
|   |                              | $>360.000$ to $\leq 384.224$     | 24                       |                  |           |
|   | 12                           | All allowed values               | 28                       | 10000000         | 1         |

Table 34: Minimum Allowed and Maximum Possible Exposure Times With Dependencies

## 6.5.3 Setting the Parameter Value

You can use the Basler pylon API to set the ExposureTime parameter value from within your application software. The following code snippet illustrates using the API to set the parameter value:

```
// Set the exposure time to 3500  $\mu$ s
camera.ExposureTime.SetValue(3500.0);
```

You can also use the Basler pylon Viewer application to easily set the parameter.

For more information about the pylon API and pylon Viewer, see Section 3.1 on page 62.

## 6.6 Electronic Shutter Operation

All ace cameras are equipped with imaging sensors that have an electronic shutter. There are two types of sensors that differ by design and support either the global or the rolling shutter mode . Some of the sensors with a rolling shutter also support the global reset release shutter mode which is a variant of the rolling shutter mode.

All ace models except the acA1920-25um/uc, acA2500-14um/uc, acA3800-14um/uc, and acA4600-10uc use sensors with only global shutter modes. Some of the sensors with global shutter allow to choose between "normal" or "fast" sensor readout.

The sensors of the acA1920-25um/uc, acA2500-14um/uc, acA3800-14um/uc, and acA4600-10uc camera models support the rolling shutter mode and the global reset release shutter mode.

The following sections describe the differences between the shutter modes.

### 6.6.1 Global Shutter (All Cameras Except acA1920-25, acA2500-14, acA3800-14, acA4600-10)

All camera models other than the acA1920-25um/uc, acA2500-14um/uc, acA3800-14um/uc, and acA4600-10uc are equipped with an electronic global shutter. On cameras equipped with a global shutter, when frame acquisition is triggered, exposure begins for all lines in the sensor as shown in Figure 60. Exposure continues for all lines in the sensor until the programmed exposure time ends (or when the frame start trigger signal ends the exposure time, if the camera is using the trigger width exposure mode). At the end of the exposure time, exposure ends for all lines in the sensor. Immediately after the end of exposure, pixel data readout begins and proceeds in a linewise fashion until all pixel data is read out of the sensor.

A main characteristic of a global shutter is that for each frame acquisition, all of the pixels in the sensor start exposing at the same time and all stop exposing at the same time. This means that image brightness tends to be more uniform over the entire area of each acquired image, and it helps to minimize problems with acquiring images of objects in motion.

The cameras can provide an exposure active output signal that will go high when the exposure time for the first line begins and will go low when the exposure time for the last line ends.

The sensor readout time (see [Figure 60](#)) is the sum of the line readout times and therefore also depends on ROI height. You can determine the readout time for a frame by checking the value of the camera's SensorReadoutTime parameter.

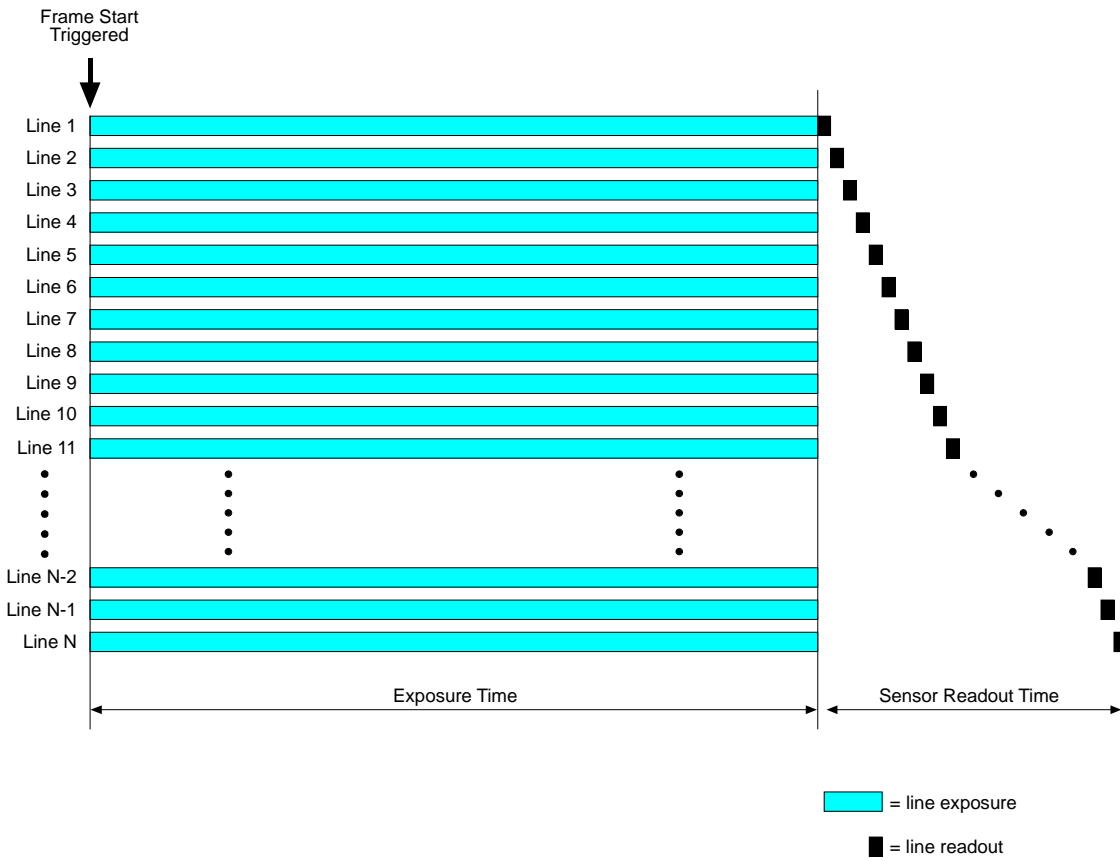

Fig. 60: Global Shutter

For more information about the exposure active output signal, see Section 6.8.1 on [page 167](#).

For more information about the SensorReadoutTime parameter, see Section 6.9 on [page 180](#).

### 6.6.1.1 Sensor Readout Mode

The acA640-750um/uc, acA800-510um/uc, acA1300-200um/uc, acA1920-150um/uc, and acA2500-60uc cameras are equipped with sensors that allow to set the sensor readout mode. Two modes are available, "normal" and "fast".

In fast sensor readout mode, the readout time for each line of pixels (the line readout time) is shortened compared to the normal readout mode. As a consequence, the overall sensor readout time is shortened. This allows you to increase the maximum frame rate compared to operation in normal sensor readout mode. Note, however, that the image quality can deteriorate when using fast sensor readout mode.

Remember that you can further decrease the readout time for the pixel data of a frame by decreasing the ROI height (see Section 6.6.1 on [page 148](#)).

You can determine the readout time for a frame by checking the value of the camera's SensorReadoutTime parameter (Section 6.9 on [page 180](#)).

#### Setting the Sensor Readout Mode

The following code snippet illustrates using the API to set and read the parameter values for the Sensor Readout Mode (values: Normal, Fast):

```
// Set and read the sensor readout mode parameter value
camera.SensorReadoutMode.SetValue(SensorReadoutMode_SensorReadoutMode_Normal);
camera.SensorReadoutMode.SetValue(SensorReadoutMode_SensorReadoutMode_Fast);
SensorReadoutModeEnums e = camera.SensorReadoutMode.GetValue();
```

You can also use the Basler pylon Viewer application to easily set the parameter.

For more information about the pylon API and pylon Viewer, see Section 3.1 on [page 62](#).

## 6.6.2 Rolling Shutter (acA1920-25, acA2500-14, acA3800-14, acA4600-10 Only)

The acA1920-25um/uc, acA2500-14um/uc, acA3800-14um/uc, and acA4600-10uc cameras are equipped with an electronic rolling shutter. The rolling shutter is used to control the start and stop of sensor exposure. The rolling shutter used in these cameras has two shutter modes: rolling and global reset release.

### 6.6.2.1 Rolling Mode

When the shutter is in the rolling mode, it exposes and reads out the pixel lines with a temporal offset (designated as  $t_{Row}$ ) from one line to the next (see [Figure 61](#)). When frame start is triggered, the camera resets the top line of pixels of the ROI (line one) and begins exposing that line. The camera resets line two  $t_{Row}$  later and begins exposing the line. The camera resets line three  $t_{Row}$  later and begins exposing the line. And so on until the bottom line of pixels is reached.

The exposure time is the same for all lines and is determined by the ExposureTime parameter setting.

The pixel values for each line are read out at the end of exposure for the line. Because the readout time for each line is also  $t_{Row}$ , the temporal shift for the end of readout is identical to the temporal shift for the start of exposure.

| Camera Model    | Temporal Shift $t_{Row}$ |                       |                     |
|-----------------|--------------------------|-----------------------|---------------------|
|                 | 8 bit Pixel Format       | 12 bit p Pixel Format | 12 bit Pixel Format |
| acA1920-25um/uc | 35.000 $\mu$ s           | 35.000 $\mu$ s        | 35.000 $\mu$ s      |
| acA2500-14um/uc | 35.000 $\mu$ s           | 35.000 $\mu$ s        | 35.000 $\mu$ s      |
| acA3800-14um/uc | 24.725 $\mu$ s           | 28.475 $\mu$ s        | 30.975 $\mu$ s      |
| acA4600-10uc    | 30.750 $\mu$ s           | 33.875 $\mu$ s        | 37.000 $\mu$ s      |

Table 35: Temporal Shift for Start of Exposure Between Two Consecutive Lines

The Sensor Readout Time is the sum of the readout times of all lines. The Total Readout Time equals the Sensor Readout Time plus the Exposure Overhead time  $C_1$ . The Exposure Overhead time is needed to prepare the sensor for the next acquisition.



| Camera Model | Exposure Overhead C <sub>1</sub> |                       |                     |
|--------------|----------------------------------|-----------------------|---------------------|
|              | 8 bit Pixel Format               | 12 bit p Pixel Format | 12 bit Pixel Format |
| acA1920-25um | 490 µs                           | 490 µs                | 490 µs              |
| acA2500-14um | 490 µs                           | 490 µs                | 490 µs              |
| acA3800-14um | 3536 µs                          | 4072 µs               | 4430 µs             |

Table 36: Exposure Overhead Time for Mono Cameras in Rolling Mode

| Camera Model | Exposure Overhead C <sub>1</sub> |                       |                     |
|--------------|----------------------------------|-----------------------|---------------------|
|              | 8 bit Pixel Format               | 12 bit p Pixel Format | 12 bit Pixel Format |
| acA1920-25uc | 525 µs                           | 525 µs                | 525 µs              |
| acA2500-14uc | 525 µs                           | 525 µs                | 525 µs              |
| acA3800-14uc | 3561 µs                          | 4101 µs               | 4461 µs             |
| acA4600-10uc | 4521 µs                          | 4980 µs               | 5439 µs             |

Table 37: Exposure Overhead Time for Color Cameras in Rolling Mode

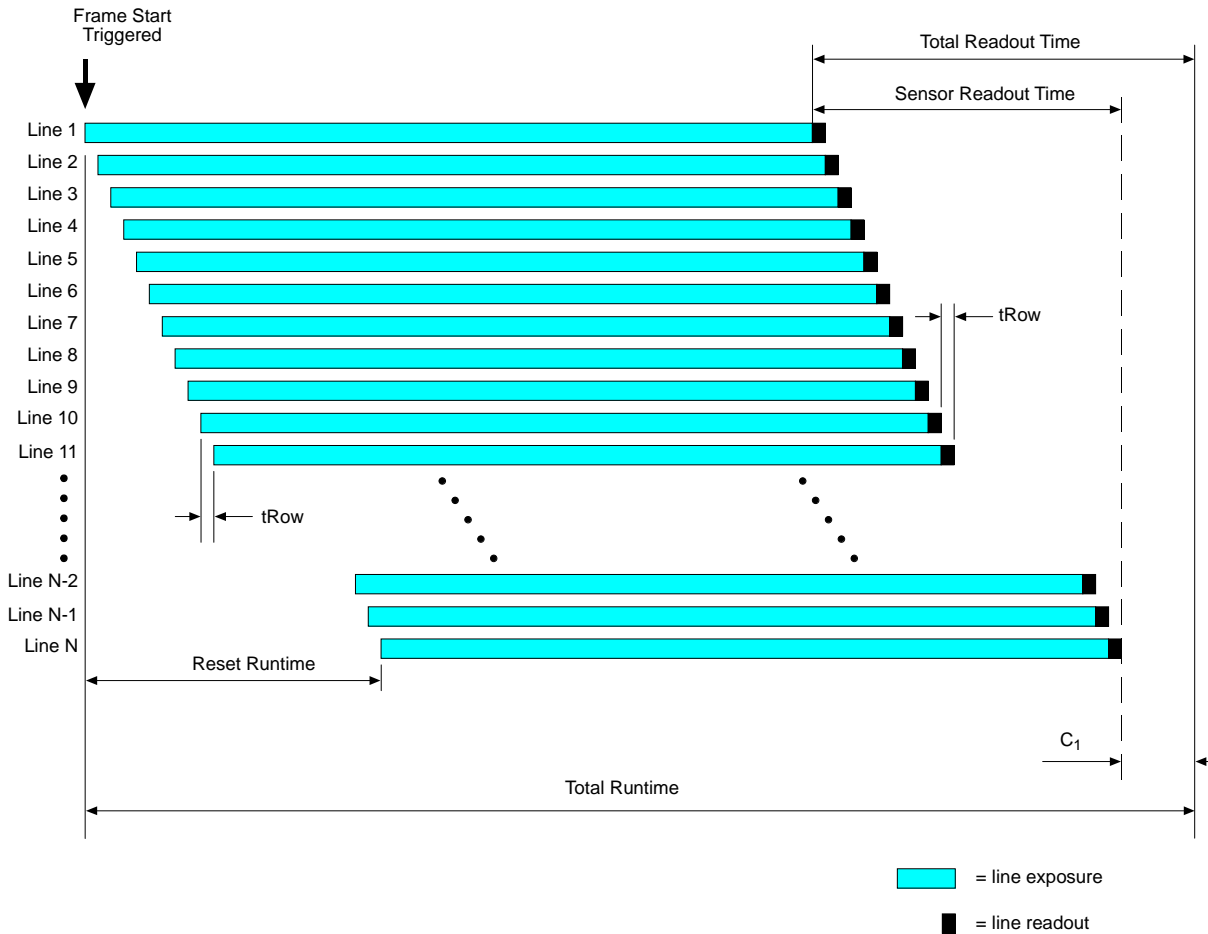

Fig. 61: Rolling Shutter in Rolling Mode

You can calculate the reset runtime using this formula:

$$\text{Reset Runtime} = t_{\text{Row}} \times (\text{ROI Height} - 1)$$

You can calculate the total readout time using this formula:

$$\text{Total Readout Time} = [ t_{\text{Row}} \times (\text{ROI Height}) ] + C_1 \mu\text{s}$$

You can calculate the total runtime using this formula:

$$\text{Total Runtime} = \text{ExposureTime Parameter Setting} + \text{Total Readout Time}$$

## Using the Exposure Active and Flash Window Output Signals

The acA1920-25 and acA2500-14 cameras can provide an exposure active output signal that goes high when the exposure time for line one begins and goes low when the exposure time for line one ends.

The exposure active signal is not available for acA3800-14 and acA4600-10 cameras. However, the flash window signal is available and may in some cases serve as an alternative (see Section 6.8.2 on [page 169](#))

If the camera is operating in rolling mode and you are using the camera to capture images of moving objects, the use of flash lighting is most strongly recommended. The camera supplies a flash window output signal to facilitate the use of flash lighting.



In rolling mode, the flash window signal is not available when the exposure time for the first row elapses before exposure for the last row of the current ROI has started, i.e., more specifically, when  $\text{Exposure Time} \leq \text{Reset Runtime}$ .

For more information about the exposure active output signal, see Section 6.8.1 on [page 167](#).

For more information about the ExposureTime parameter, see Section 6.5 on [page 145](#).

For more information about the flash window, see Section 6.6.2.3 on [page 157](#).

### 6.6.2.2 Global Reset Release Mode

The global reset release mode is a variant of the rolling mode.

When the shutter is operating in global reset release mode, all of the lines in the sensor reset and begin exposing when frame start is triggered (see [Figure 62](#)). However, in the end of exposure, there is a temporal offset (designated as tRow) from one line to the next. The tRow values are the same as for the rolling mode (see [Table 35](#) on [page 151](#)).

The pixel values for each line are read out at the end of exposure time for the line. The readout time for each line is also equal to tRow.

The exposure time for line one is determined by the ExposureTime parameter setting. The exposure for line two will end tRow after the exposure ends for line one. The exposure for line three will end tRow after the exposure ends for line two. And so on until the bottom line of pixels is reached.

The Sensor Readout Time is the sum of the readout times of all lines. The Total Readout Time equals the Sensor Readout Time plus the Exposure Overhead time  $C_1$ .

| Camera Model | Exposure Overhead C <sub>1</sub> |                       |                     |
|--------------|----------------------------------|-----------------------|---------------------|
|              | 8 bit Pixel Format               | 12 bit p Pixel Format | 12 bit Pixel Format |
| acA1920-25um | 810 µs                           | 810 µs                | 810 µs              |
| acA2500-14um | 810 µs                           | 810 µs                | 810 µs              |
| acA3800-14um | 22285 µs                         | 28516 µs              | 48371 µs            |

Table 38: Exposure Overhead Time for Mono Cameras in Global Reset Release Mode

| Camera Model | Exposure Overhead C <sub>1</sub> |                       |                     |
|--------------|----------------------------------|-----------------------|---------------------|
|              | 8 bit Pixel Format               | 12 bit p Pixel Format | 12 bit Pixel Format |
| acA1920-25uc | 810 µs                           | 810 µs                | 810 µs              |
| acA2500-14uc | 810 µs                           | 810 µs                | 810 µs              |
| acA3800-14uc | 22310 µs                         | 28545 µs              | 48402 µs            |
| acA4600-10uc | 23273 µs                         | 30513 µs              | 61217 µs            |

Table 39: Exposure Overhead Time for Color Cameras in Global Reset Release Mode



If you want to use a flash window the global reset release mode gives you advantages over using the rolling mode:

- In global reset release mode the flash window width extends over the entire exposure time of a line in a sensor. In rolling mode, however, the flash window width can only extend over part of the exposure time of a sensor line (compare [Figure 62](#) and [Figure 63](#)). Therefore, at a given frame rate, the global reset release mode allows for longer useful exposure times.
- In global reset release mode a flash window is always available, whereas in rolling mode it is not if  $\text{Exposure Time} \leq \text{Reset Runtime}$ .
- In global reset release mode the flash window opens immediately after the frame start trigger has occurred. For switching a flash on and off you therefore do not have to wait and do not depend on the flash window signal but can use the Exposure Active signal instead, if available. For more information about the Exposure Active signal, see Section 6.8.1 on [page 167](#).

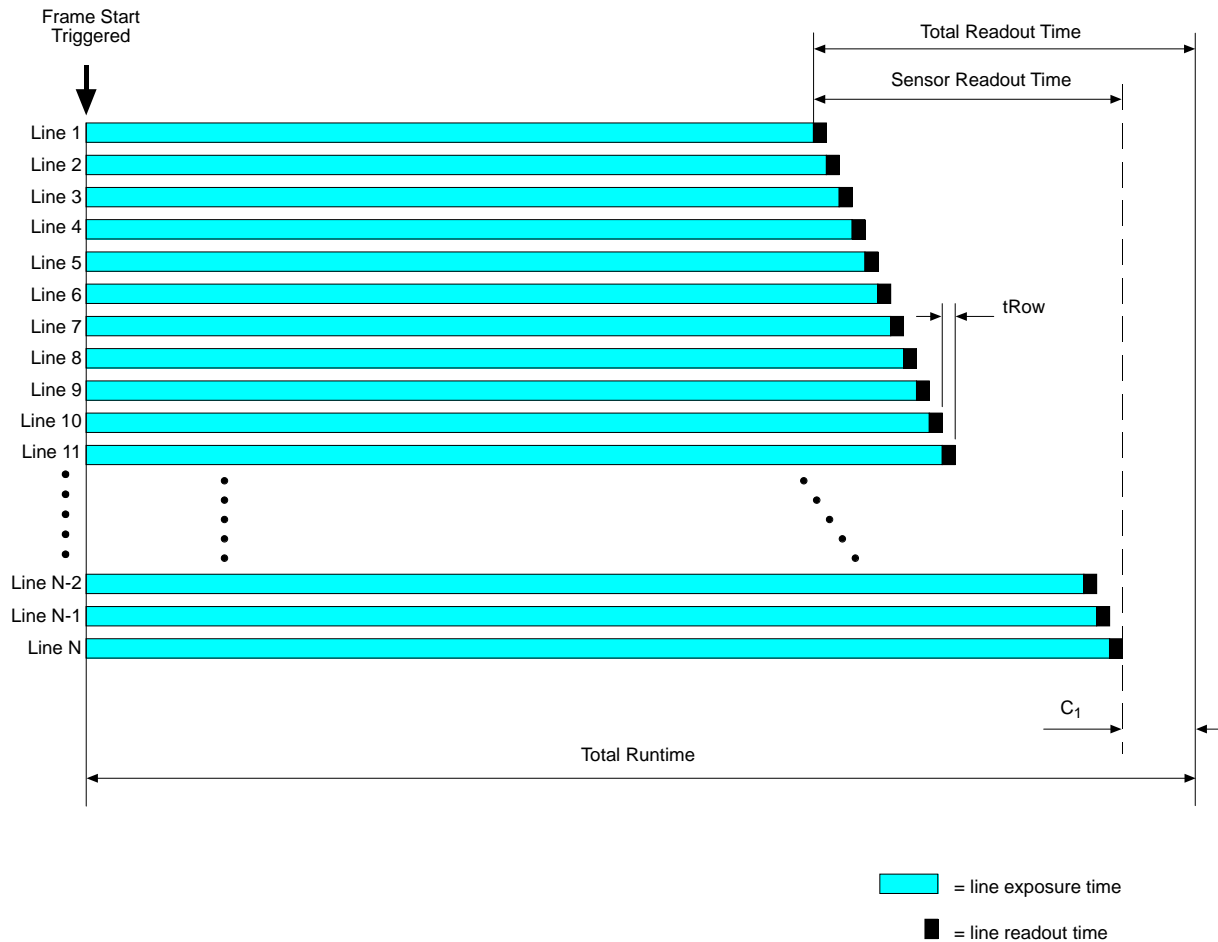

Fig. 62: Rolling Shutter in Global Reset Release Mode

You can calculate the total readout time using this formula:

$$\text{Total Readout Time} = [ t_{\text{Row}} \times (\text{ROI Height}) ] + C_1 \mu\text{s}$$

You can calculate the total runtime using the following formula:

$$\text{Total Runtime} = \text{ExposureTime Parameter Setting} + \text{Total Readout Time}$$

The cameras can provide an exposure active output signal that goes high when the exposure time for line one begins and goes low when the exposure time for line one ends.

When the camera is operating in global release mode, the use of flash lighting is most strongly recommended. The camera can supply a flash window output signal to facilitate the use of flash lighting.

For more information about the exposure active output signal, see Section 6.8.1 on [page 167](#).

For more information about the ExposureTime parameter, see Section 6.5 on [page 145](#).

For more information about the flash window, see Section 6.6.2.3 on [page 157](#).

For more information about the flash window output signal, see Section 6.8.2 on [page 169](#).

## Setting the Shutter Mode

The cameras have two shutter modes: rolling and global reset release.

You can set the shutter mode from within your application software by using the Basler pylon API. The following code snippets illustrate using the API to set the shutter modes:

```
// Set the shutter mode to rolling
camera.ShutterMode.SetValue(ShutterMode_Rolling);

// Set the shutter mode to global reset release
camera.ShutterMode.SetValue(ShutterMode_GlobalResetRelease);
```

You can also use the Basler pylon Viewer application to easily set the mode.

### 6.6.2.3 The Flash Window

#### Flash Window in Rolling Mode

If you are using the rolling mode, capturing images of moving objects requires the use of flash exposure. If you don't use flash exposure when capturing images of moving objects, the images will be distorted due to the temporal shift between the start of exposure for each line.

You can avoid distortion problems by using flash lighting and by applying the flash during the "flash window" for each frame. The flash window is the period of time during a frame acquisition when all of the lines in the sensor are open for exposure.

[Figure 63](#) illustrates the flash window for the rolling mode.

You can calculate when the flash window opens (i.e., the time from the point where the frame is triggered until the point where the window opens) using this formula:

$$\text{Time to Flash Window Open} = t_{\text{Row}} \times (\text{ROI Height} - 1)$$

You can calculate the flash window width (i.e., how long the flash window remains open) using this formula:

$$\text{Flash Window Width} = \text{ExposureTime Parameter Setting} - [ (t_{\text{Row}} \times (\text{ROI Height} - 1) ]$$

The  $t_{\text{Row}}$  values are the same as for both, rolling and global reset release mode and are given in [Table 35](#) on [page 151](#).

To facilitate the use of flash lighting, you can use the flash window output signal (see Section 6.8.2 on [page 169](#)). The flash window signal goes high when the flash window opens and goes low when the flash window closes.

 In rolling mode, the flash window signal is not available when the exposure time for the first row elapses before exposure for the last row of the current ROI has started, i.e., more specifically, when  $\text{Exposure Time} \leq \text{Reset Runtime}$ .

For more information about the ExposureTime parameter, see Section 6.5 on [page 145](#).

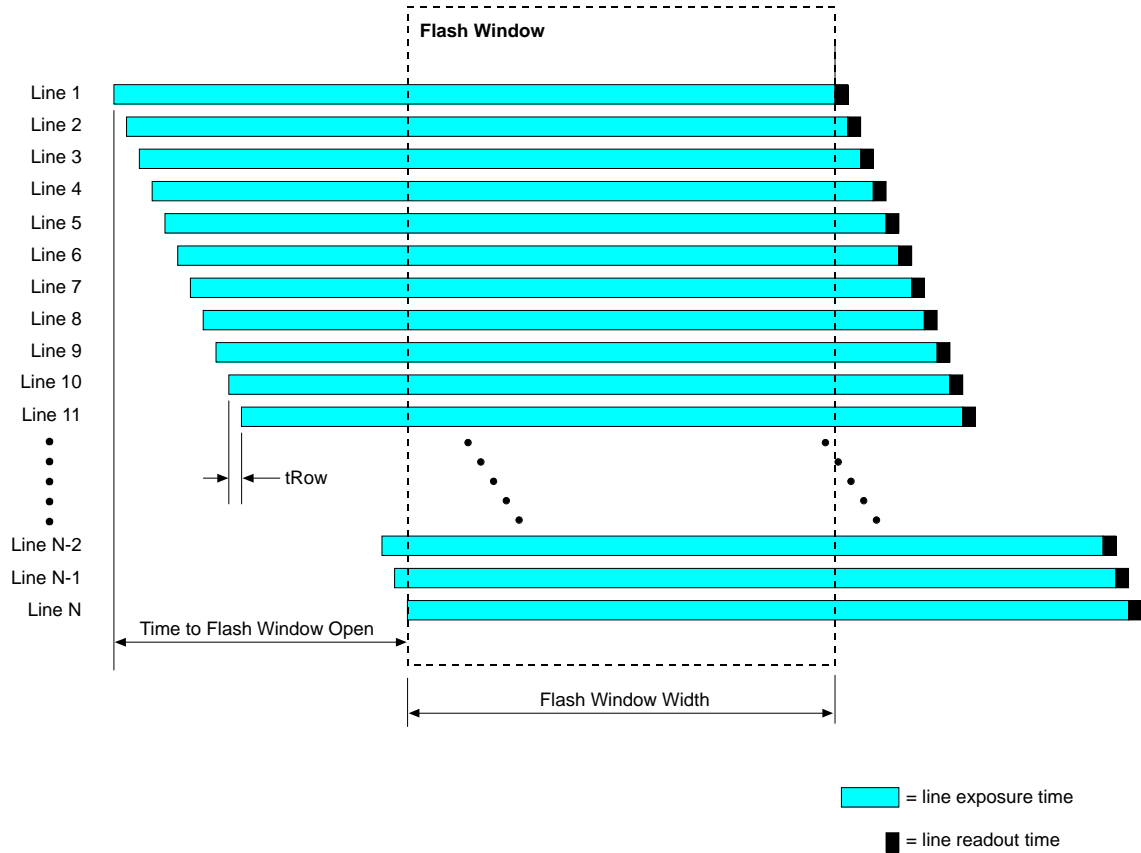

Fig. 63: Flash Window for Rolling Shutter in Rolling Mode

## Flash Window in Global Reset Release Mode

If you are using the global reset release mode, you should use flash exposure for capturing images of both stationary and moving objects. If you don't use flash exposure when capturing images of stationary objects, the brightness in each acquired image will vary significantly from top to bottom due to the differences in the exposure times of the lines. If you don't use flash exposure when capturing images of moving objects, the brightness in each acquired image will vary significantly from top to bottom due to the differences in the exposure times of the lines and the images will be distorted due to the temporal shift between the end of exposure for each line.

You can avoid these problems by using flash lighting and by applying the flash during the "flash window" for each frame. The flash window is the period of time during a frame acquisition when all of the lines in the sensor are open for exposure.

Figure 64 illustrates the flash window for the global reset release mode.

In global reset release mode, the flash window opens when the frame is triggered and closes after a time period equal to the ExposureTime parameter setting. Thus, the flash window width (i.e., how long the flash window will remain open) is equal to the ExposureTime parameter setting.

To facilitate the use of flash lighting, you can use the flash window output signal (see Section 6.8.2 on [page 169](#)). The flash window signal goes high when the flash window opens and goes low when the flash window closes.

For more information about the ExposureTime parameter, see Section 6.5 on [page 145](#).



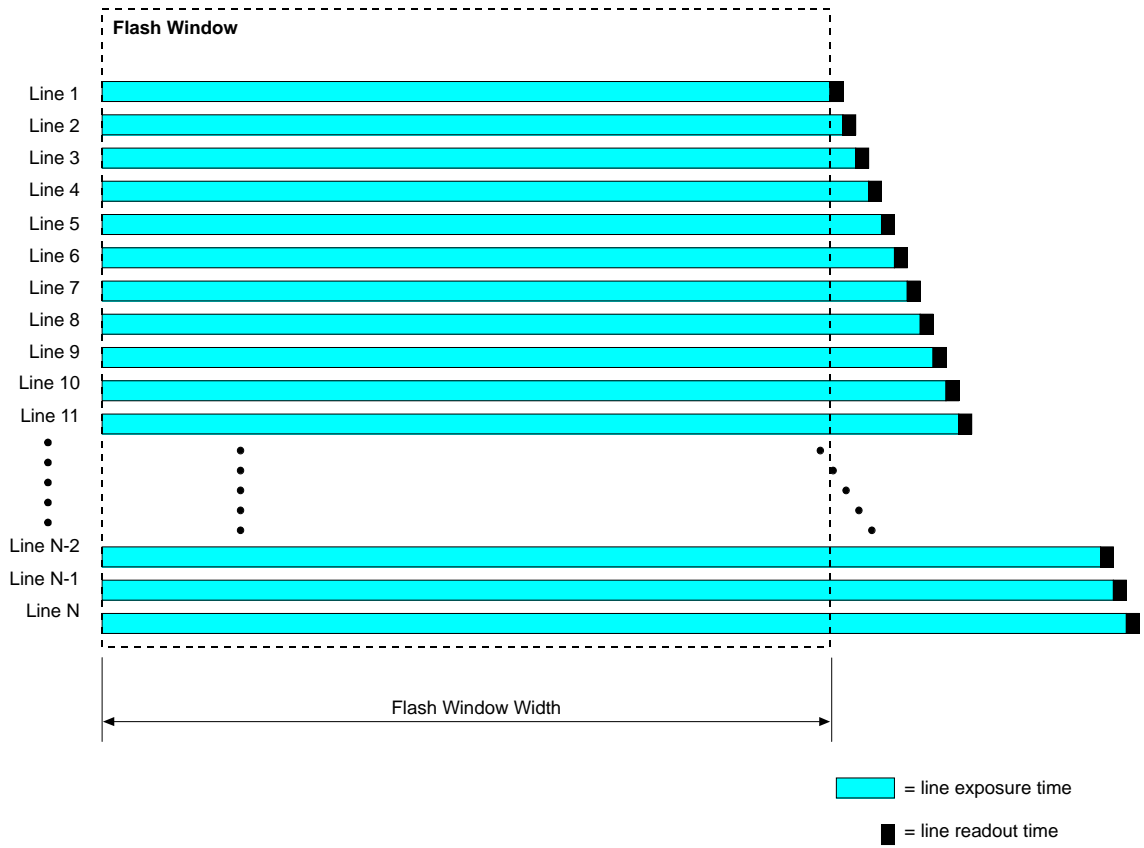

Fig. 64: Flash Window for Rolling Shutter in Global Reset Release Mode

## 6.7 Overlapping Image Acquisitions

### 6.7.1 Overlapping Image Acquisitions for All Models Except acA1920-25, acA2500-14, acA3800-14, acA4600-10

The frame acquisition process on the camera includes two distinct parts. The first part is the exposure of the pixels in the imaging sensor. Once exposure is complete, the second part of the process – readout of the pixel values from the sensor – takes place. In regard to this frame acquisition process, there are two common ways for the camera to operate: with “non-overlapped” exposure and with “overlapped” exposure.

In the non-overlapped mode of operation, each time a frame is acquired the camera completes the entire exposure/sensor readout process before acquisition of the next frame is started. The exposure for a new frame does not overlap the sensor readout for the previous frame. This situation is illustrated in Figure 65 with the camera set for the trigger width exposure mode.

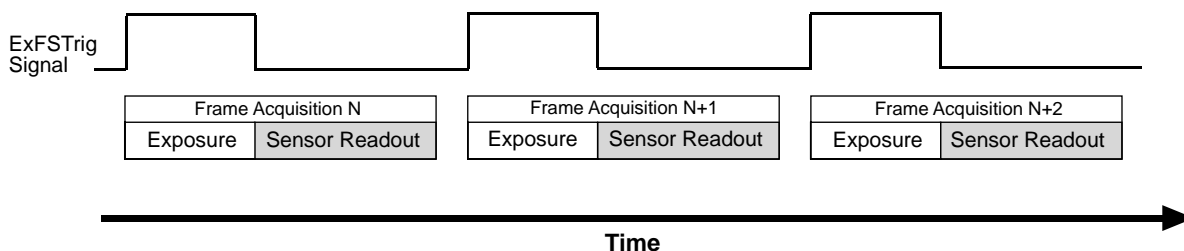

Fig. 65: Non-overlapped Exposure and Sensor Readout

In the overlapped mode of operation, the exposure of a new frame begins while the camera is still reading out the sensor data for the previously acquired frame. This situation is illustrated in Figure 66 with the camera set for the trigger width exposure mode.

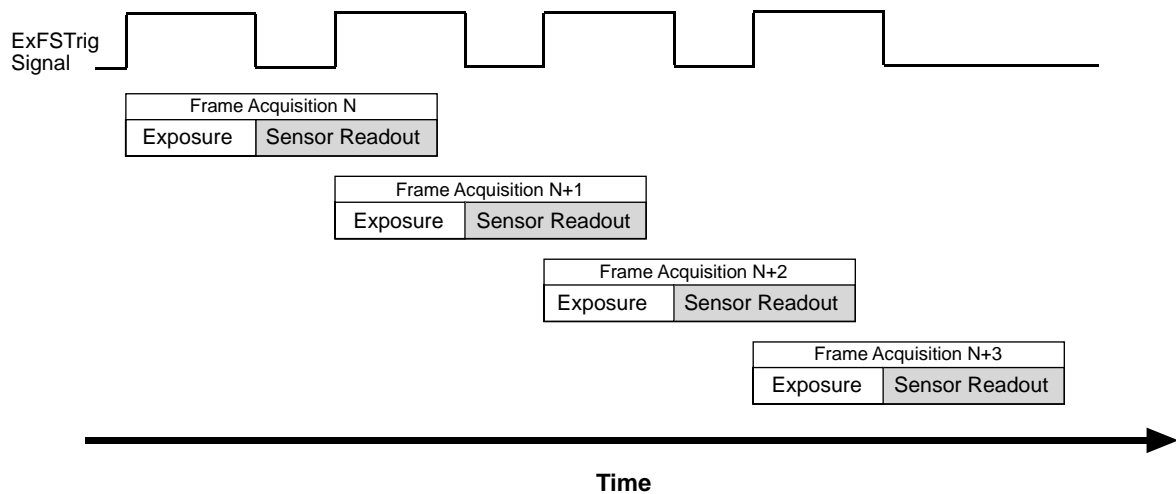

Fig. 66: Overlapped Exposure and Sensor Readout

Determining whether your camera is operating with overlapped or non-overlapped exposure and readout is not a matter of issuing a command or switching a setting on or off. Rather the way that you operate the camera will determine whether the exposures and readouts are overlapped or not. If we define the “frame period” as the time from the start of exposure for one frame acquisition to the start of exposure for the next frame acquisition, then:

- Exposure will not overlap when:  $\text{Frame Period} > \text{Exposure Time} + \text{Sensor Readout Time}$
- Exposure will overlap when:  $\text{Frame Period} \leq \text{Exposure Time} + \text{Sensor Readout Time}$

You can determine the sensor readout time by reading the value of the Sensor Readout Time parameter. The parameter indicates what the readout time will be in microseconds given the camera’s current settings. You can read the Readout Time parameter value from within your application software by using the Basler pylon API. The following code snippet illustrates using the API to get the parameter value:

```
double d = camera.SensorReadoutTime.GetValue();
```

You can also use the Basler pylon Viewer application to easily get the parameter value.

For more information about the pylon API and the pylon Viewer, see Section 3.1 on [page 62](#).

## Guideline for Overlapped Operation with Trigger Width Exposure

If the camera is set for the trigger width exposure mode and you are operating the camera in a way that readout and exposure will be overlapped, there is an important guideline you must keep in mind:

You must not end the exposure time of the current frame acquisition until readout of the previously acquired frame is complete.

If this guideline is violated, the camera will drop the frame for which the exposure was just ended and will declare a Frame Start Overtrigger event. This situation is illustrated in Figure 67 with the camera set for the trigger width exposure mode with rising edge triggering.

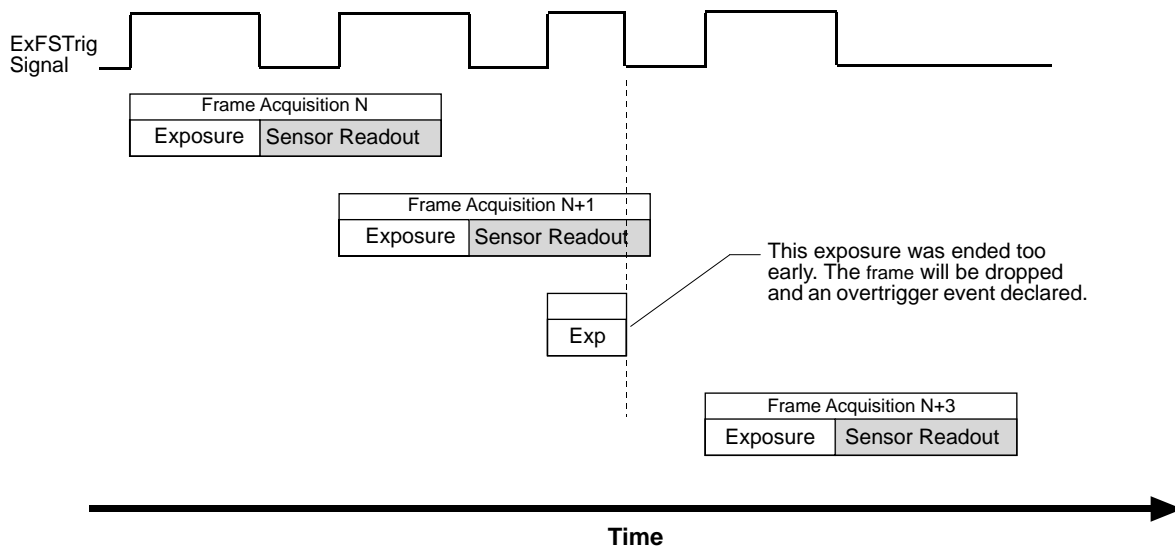

Fig. 67: Overtriggering Caused by an Early End of Exposure

You can avoid violating this guideline by using the camera's Frame Trigger Wait signal to determine when exposure can safely begin and by properly setting the camera's Exposure Overlap Time Max parameter.

For more information about the Frame Trigger Wait signal and the Exposure Overlap Time Max parameter, see Section 6.8.4.2 on [page 174](#).

For more information about trigger width exposure, see Section 6.4.3.2 on [page 136](#).

## 6.7.2 Overlapping Image Acquisitions for acA1920-25, acA2500-14, acA3800-14, acA4600-10



- Overlapped frame acquisition cannot be performed when the camera's shutter is set for global reset release mode. Overlapped frame acquisition can only be performed when the camera's shutter is in the rolling mode.
- acA3800-14 and acA4600-10 cameras allow overlapped frame acquisition only when they are triggered internally ("free run"), i.e. when Trigger Mode is set to Off for the Frame Burst Start trigger and for the Frame Start Trigger.

When using a camera with a rolling shutter, there are two common ways for the camera to operate: with "non-overlapped" acquisition and with "overlapped" acquisition.

In the non-overlapped mode of operation, each time a frame is acquired the camera completes the entire acquisition process for a frame, consisting of exposure plus sensor readout, before acquisition of the next frame is started. The acquisition of a new frame does not overlap any part of the acquisition process for the previous frame. This situation is illustrated in [Figure 68](#) with the camera using an external frame start trigger.

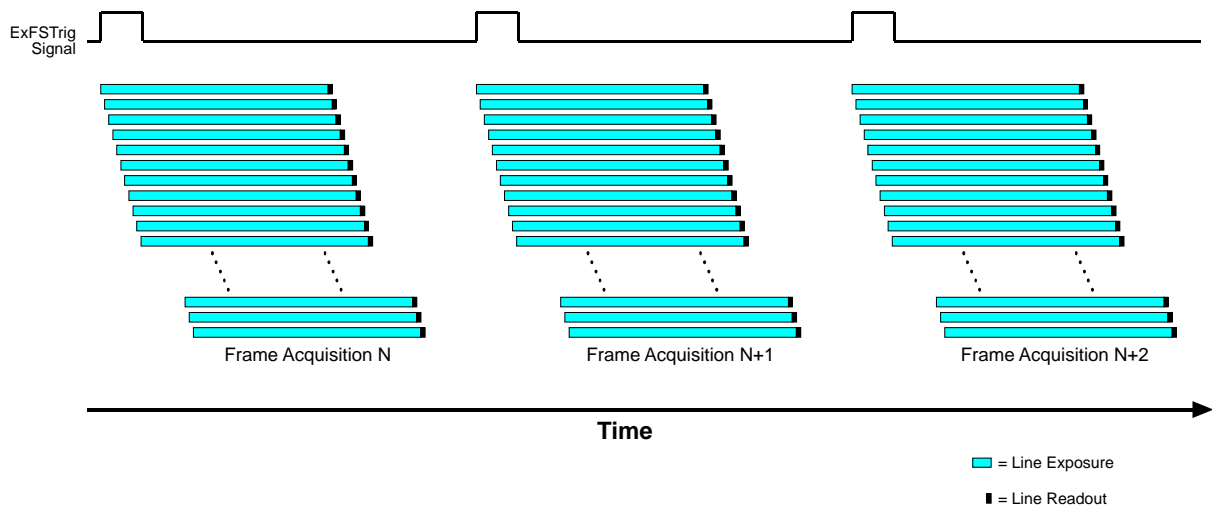

Fig. 68: Non-overlapped Acquisition

In the overlapped mode of operation, the acquisition for a new frame begins while the camera is still completing the acquisition process for the previous frame. This situation is illustrated in [Figure 69](#).

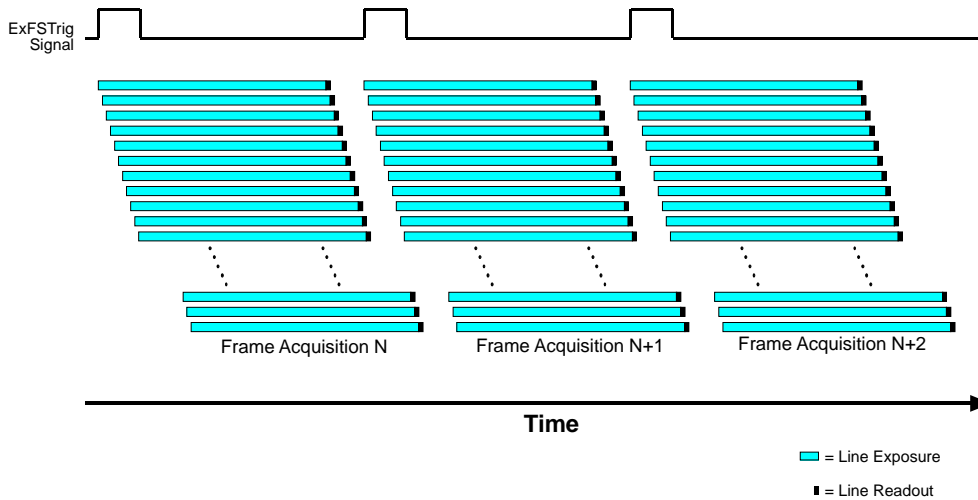

Fig. 69: Overlapped Exposure and Sensor Readout

Determining whether your camera is operating with overlapped or with non-overlapped acquisition is not a matter of issuing a command or switching a setting on or off. Rather the way that you operate the camera will determine whether the frame acquisitions are overlapped or not. If we define the “frame period” as the time from the start of exposure for line one in the frame N acquisition to the start of exposure for line one in frame N+1 acquisition, then:

- Exposure will not overlap when:
  - Frame Period > ExposureTime Parameter Setting + Total Sensor Readout Time
- Exposure will overlap when:
  - Frame Period ≤ ExposureTime Parameter Setting + Total Sensor Readout Time

You can determine the total sensor readout time for a frame by reading the value of the Sensor Readout Time parameter. This parameter indicates the time in microseconds from the beginning of readout for line one to the end of readout for line N (the last line). You can read the Readout Time parameter value from within your application software by using the Basler pylon API. The following code snippet illustrates using the API to get the parameter value:

```
double d = camera.SensorReadoutTime.GetValue();
```

You can also use the Basler pylon Viewer application to easily get the parameter value.

For more information about the pylon API and the pylon Viewer, see Section 3.1 on [page 62](#).

## Guideline for Overlapped Acquisition

If you are operating the camera in such a way that frame acquisitions will be overlapped, there is an important guideline you must keep in mind:

You must wait a minimum of  $400\ \mu\text{s}$  after the end of exposure for line one in frame N before you can trigger acquisition of frame N+1. This requirement is illustrated in Figure 70

If this guideline is violated, the camera will ignore the frame start trigger signal and will declare a Frame Start Overtrigger event.

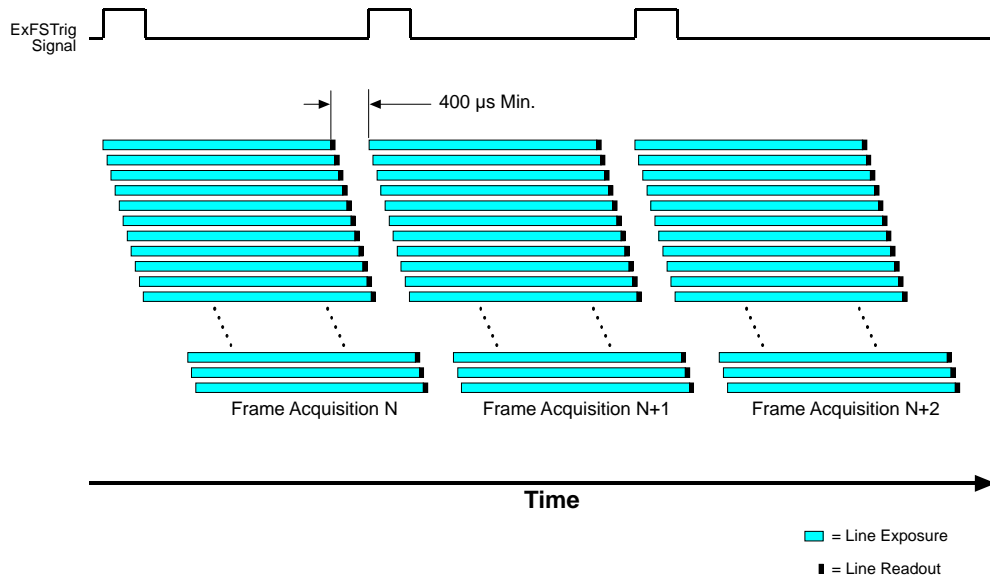

Fig. 70: Acquisition Overlap Guideline

You can avoid violating this guideline by using the camera's Frame Trigger Wait signal to determine when exposure can safely begin.

## 6.8 Acquisition Monitoring Tools

### 6.8.1 Exposure Active Signal

#### Exposure Active on Global Shutter Cameras (All Models Except the acA1920-25, acA2500-14, acA3800-14, acA4600-10)

Cameras with a global shutter imaging sensor can provide an "exposure active" (ExpAc) output signal. On these cameras, the high state of the signal indicates a logical one on the FPGA output side (Figure 71, see also Figure 40). This signal can be used as a flash trigger and is also useful when you are operating a system where either the camera or the object being imaged is movable. For example, assume that the camera is mounted on an arm mechanism and that the mechanism can move the camera to view different portions of a product assembly. Typically, you do not want the camera to move during exposure. In this case, you can monitor the ExpAc signal to know when exposure is taking place and thus know when to avoid moving the camera.



When you use the exposure active signal, be aware that there is a delay in the rise and the fall of the signal in relation to the start and the end of exposure (see Figure 71).

Using a GPIO line, set for output, will bring about shorter delays, compared to using the opto-isolated output line. The exact delays depend on several factors. See Section 5.10.2 on page 90 for details.

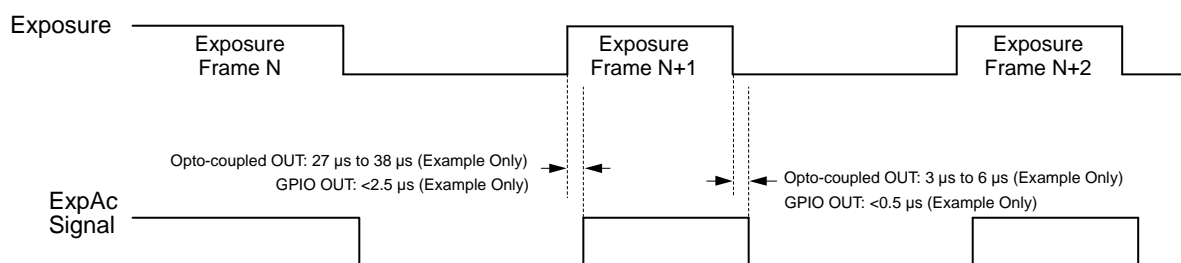

Timing charts are not drawn to scale.

The times stated are **only** given as examples. They are **only valid** for the operating conditions given in Section 5.10.3.

Fig. 71: Exposure Active Signal on Cameras with a Global Shutter



## Exposure Active on Rolling Shutter Cameras (acA1920-25, acA2500-14 Only)

Some cameras with a rolling shutter imaging sensor can provide an "exposure active" (ExpAc) output signal. On these cameras, the signal goes high when exposure for the first line in a frame begins and goes low when exposure for the last line ends as shown in [Figure 72](#). This behavior applies to both, the rolling mode and global reset release mode.

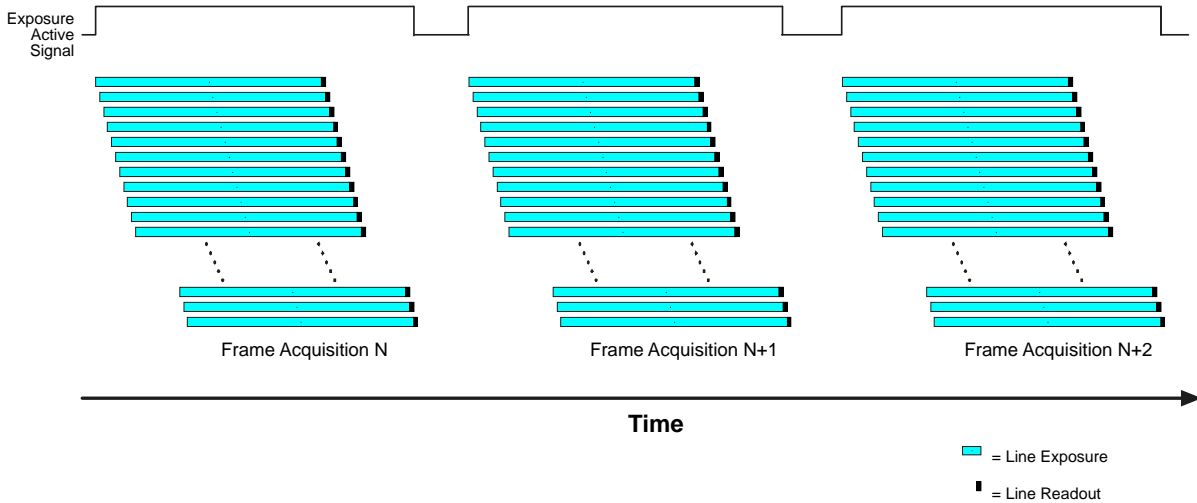

Fig. 72: Exposure Active Signal on Cameras Operating in Rolling Mode



The exposure active signal is not available for acA3800-14, and acA4600-10 cameras. However, the flash window signal is available and may in some cases serve as an alternative (see [Section 6.8.2](#) on [page 169](#)).

## Selecting the Exposure Active Signal as the Source Signal for an Output Line

The exposure active output signal can be selected to act as the source signal for an output line, e.g. Line 2. Selecting a source signal for the output line is a two step process:

- Use the Line Selector to select the output line, e.g. Line 2.
- Set the value of the Line Source Parameter to the exposure active output signal.

You can set the Line Selector and the Line Source parameter value from within your application software by using the Basler pylon API. The following code snippet illustrates using the API to set the selector and the parameter value:

```
camera.LineSelector.SetValue(LineSelector_Line2);
camera.LineSource.SetValue(LineSource_ExposureActive);
```

You can also use the Basler pylon Viewer application to easily set the parameters.

For more information about the pylon API and the pylon Viewer, see Section 3.1 on [page 62](#).

For more information about changing the selection of a camera output signal as the source signal for an output line, see Section 5.12.1 on [page 97](#).

For more information about the electrical characteristics of output line Line 2, see Section 5.8.1 on [page 77](#), and of GPIO Line 3 and Line 4, set for output, see Section 5.9.4.1 on [page 84](#).

## 6.8.2 Flash Window Signal

Cameras with a rolling shutter imaging sensor (acA1920-25, acA2500-14, acA3800-14, acA4600-10 models) can provide a flash window output signal to aid you in the use of flash lighting. The flash window signal will go high when the flash window for each image acquisition opens and will go low when the flash window closes. Figure 73 illustrates the flash window signal on a camera with the shutter operating in the rolling mode.

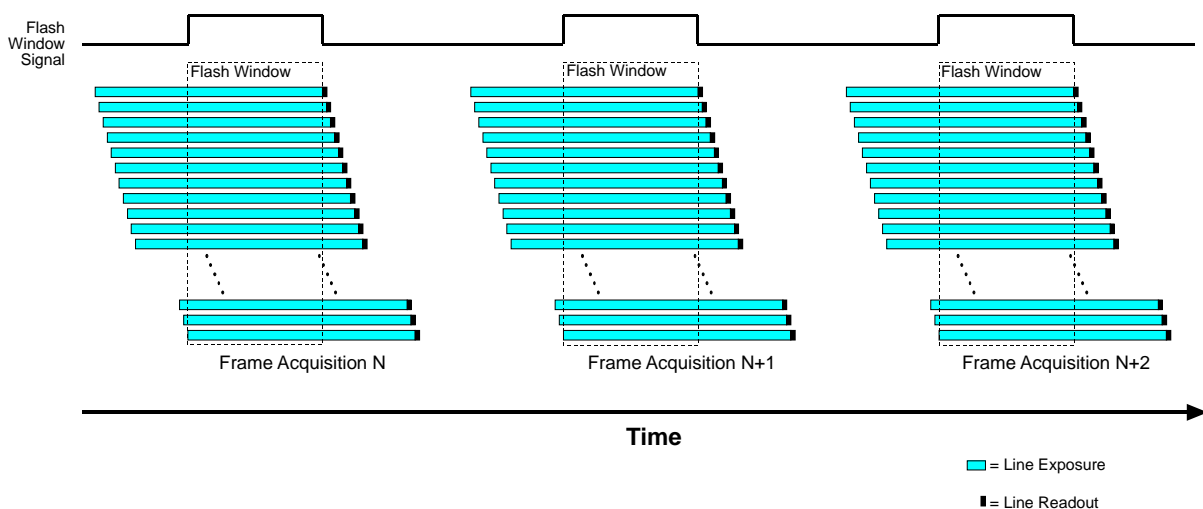

Fig. 73: Flash Window Signal on Cameras Operating in Rolling Mode



The flash window signal is also available on cameras with a global shutter imaging sensor. On global shutter cameras, the flash window signal is simply the equivalent of the exposure active signal.

For more information about the rolling shutter and the flash window, see Section 6.6.2 on [page 151](#).

## Selecting the Flash Window Signal as the Source Signal for an Output Line

The flash window output signal can be selected to act as the source signal for a camera output line, e.g. Line 2. Selecting a source signal for the output line is a two step process:

- Use the Line Selector to select the output line, e.g. Line 2.
- Set the value of the Line Source Parameter to the flash window signal.

You can set the Line Selector and the Line Source parameter value from within your application software by using the Basler pylon API. The following code snippet illustrates using the API to set the selector and the parameter value:

```
camera.LineSelector.SetValue(LineSelector_Line2);  
camera.LineSource.SetValue(LineSource_FlashWindow);
```

You can also use the Basler pylon Viewer application to easily set the parameters.

For more information about the pylon API and the pylon Viewer, see Section 3.1 on [page 62](#).

For more information about changing the selection of an output signal as the source signal for the output line, see Section 5.12.1 on [page 97](#).

For more information about the electrical characteristics of camera output lines, see Section 5.8.1 on [page 77](#) and Section 5.9.4.1 on [page 84](#).

## 6.8.3 Acquisition Status Indicator

If a camera receives a software frame burst start trigger signal when it is not in a "waiting for frame burst start trigger" acquisition status, it will simply ignore the trigger signal and will generate a frame burst start overtrigger event.

If a camera receives a software frame start trigger signal when it is not in a "waiting for frame start trigger" acquisition status, it will simply ignore the trigger signal and will generate a frame start overtrigger event.

The camera's acquisition status indicator gives you the ability to check whether the camera is in a "waiting for frame burst start trigger" acquisition status or in a "waiting for frame start trigger" acquisition status. If you check the acquisition status before you apply each software frame burst start trigger signal or each software frame start trigger signal, you can avoid applying trigger signals to the camera that will be ignored.

The acquisition status indicator is designed for use when you are using host control of image acquisition, i.e., when you are using software frame burst start trigger and frame start trigger signals.

To determine the acquisition status of the camera via the Basler pylon API:

- Use the Acquisition Status Selector to select the Frame Burst Trigger Wait status or the Frame Trigger Wait status.
- Read the value of the Acquisition Status parameter.
  - If the value is set to "false", the camera is not waiting for the trigger signal.
  - If the value is set to "true", the camera is waiting for the trigger signal.

You can check the acquisition status from within your application software by using the Basler pylon API. The following code snippet illustrates using the API to check the acquisition status:

```
// Check the frame burst start trigger acquisition status
// Set the acquisition status selector
camera.AcquisitionStatusSelector.SetValue(AcquisitionStatusSelector_FrameBurst-
TriggerWait);
// Read the acquisition status
bool a = camera.AcquisitionStatus.GetValue();

// Check the frame start trigger acquisition status
// Set the acquisition status selector
camera.AcquisitionStatusSelector.SetValue(AcquisitionStatusSelector_FrameTrig-
gerWait);
// Read the acquisition status
bool b = camera.AcquisitionStatus.GetValue();
```

You can also use the Basler pylon Viewer application to easily set the parameters.

For more information about the pylon API and pylon Viewer, see Section 3.1 on [page 62](#).

## 6.8.4 Trigger Wait Signals

If a camera receives a hardware frame burst start trigger signal when it is not in a "waiting for frame burst start trigger" acquisition status, it will simply ignore the trigger signal and will generate a frame burst start overtrigger event.

If a camera receives a hardware frame start trigger signal when it is not in a "waiting for frame start trigger" acquisition status, it will simply ignore the trigger signal and will generate a frame start overtrigger event.

The camera's frame burst trigger wait signal gives you the ability to check whether the camera is in a "waiting for frame burst start trigger" acquisition status. If you check the frame burst trigger wait signal before you apply each hardware frame burst start trigger signal, you can avoid applying frame burst start trigger signals to the camera that will be ignored.

The camera's frame trigger wait signal gives you the ability to check whether the camera is in a "waiting for frame start trigger" acquisition status. If you check the frame trigger wait signal before you apply each hardware frame start trigger signal, you can avoid applying frame start trigger signals to the camera that will be ignored.

These signals are designed to be used when you are triggering frame burst start or frame start via a hardware trigger signal.

### 6.8.4.1 Frame Burst Trigger Wait Signal

As you are acquiring frames, the camera automatically monitors the frame burst start trigger status and supplies a signal that indicates the current status. The Frame Burst Trigger Wait signal will go high whenever the camera enters a "waiting for frame burst start trigger" status. The signal will go low when an external frame burst start trigger (ExFBSTrig) signal is applied to the camera and the camera exits the "waiting for frame burst start trigger status". The signal will go high again when the camera again enters a "waiting for frame burst trigger" status and it is safe to apply the next frame burst start trigger signal.

If you base your use of the ExFBSTrig signal on the state of the frame burst trigger wait signal, you can avoid "frame burst start overtriggering", i.e., applying a frame burst start trigger signal to the camera when it is not in a "waiting for frame burst start trigger" acquisition status. If you do apply a frame burst start trigger signal to the camera when it is not ready to receive the signal, it will be ignored and a frame burst start overtrigger event will be reported.

Figure 74 illustrates the Frame Burst Trigger Wait signal with the Acquisition Burst Frame Count parameter set to 3 and with exposure and readout overlapped on a camera with a global shutter. The figure assumes that the trigger mode for the frame start trigger is set to off, so the camera is internally generating frame start trigger signals.

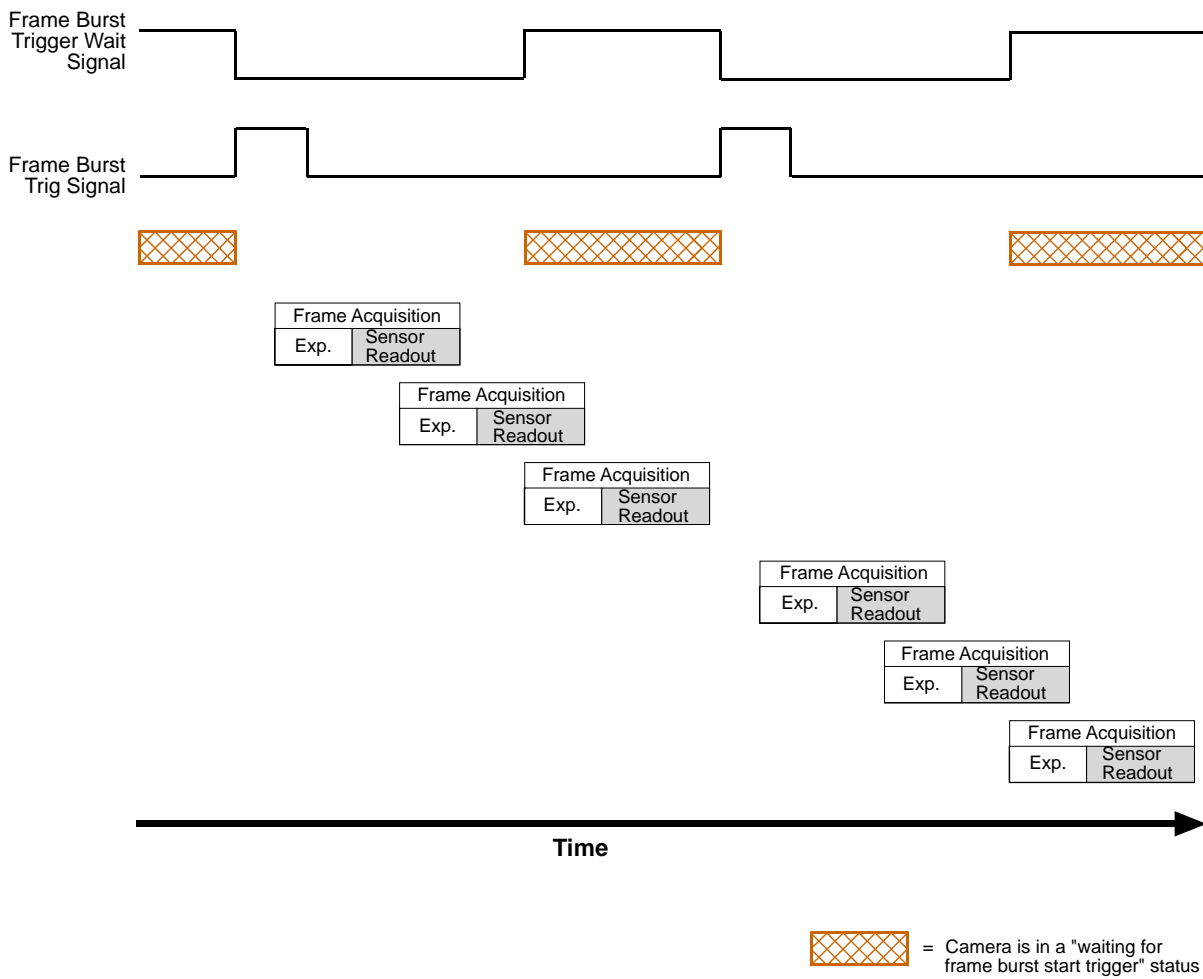

Fig. 74: Frame Burst Trigger Wait Signal



The frame burst trigger wait signal will only be available when hardware frame burst start triggering is enabled.

For more information about event notification, see Section 7.17 on [page 319](#).

## Selecting the Frame Burst Trigger Wait Signal as the Source Signal for an Output Line

The frame burst trigger wait signal can be selected to act as the source signal for a camera output line, e.g. line Line 2. Selecting a source signal for an output line is a two step process:

- Use the Line Selector to select the output line, e.g. Line 2.
- Set the value of the Line Source Parameter to the frame burst trigger wait signal.

You can set the Line Selector and the Line Source parameter value from within your application software by using the Basler pylon API. The following code snippet illustrates using the API to set the selector and the parameter value:

```
camera.LineSelector.SetValue(LineSelector_Line2);  
camera.LineSource.SetValue(LineSource_FrameBurstTriggerWait);
```

You can also use the Basler pylon Viewer application to easily set the parameters.

For more information about the pylon API and the pylon Viewer, see Section 3.1 on [page 62](#).

For more information about changing the selection of an output signal as the source signal for an output line, see Section 5.12.1 on [page 97](#).

For more information about the electrical characteristics of camera output lines, see Section 5.8.1 on [page 77](#) and Section 5.9.4.1 on [page 84](#).

### 6.8.4.2 The Frame Trigger Wait Signal

#### Overview

As you are acquiring frames, the camera automatically monitors the frame start trigger status and supplies a signal that indicates the current status. The Frame Trigger Wait signal will go high whenever the camera enters a "waiting for frame start trigger" status. The signal will go low when an external frame start trigger (ExFSTrig) signal is applied to the camera and the camera exits the "waiting for frame start trigger status". The signal will go high again when the camera again enters a "waiting for frame trigger" status and it is safe to apply the next frame start trigger signal.

If you base your use of the ExFSTrig signal on the state of the frame trigger wait signal, you can avoid "frame start overtriggering", i.e., applying a frame start trigger signal to the camera when it is not in a "waiting for frame start trigger" acquisition status. If you do apply a frame start trigger signal to the camera when it is not ready to receive the signal, it will be ignored and a frame start overtrigger event will be reported.

Figure 75 illustrates the Frame Trigger Wait signal on a camera with a global shutter. The camera is set for the trigger width exposure mode with rising edge triggering and with exposure and readout overlapped.

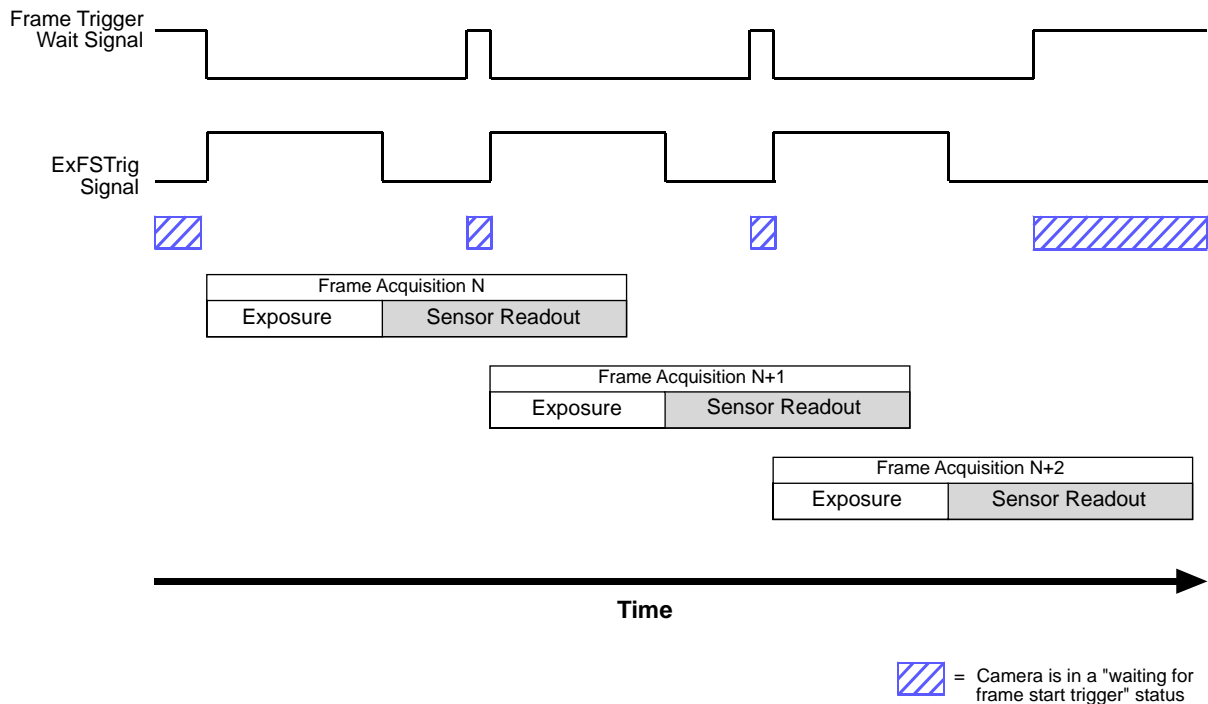

Fig. 75: Frame Trigger Wait Signal



The frame trigger wait signal will only be available when hardware frame start triggering is enabled.

For more information about event notification, see Section 7.17 on [page 319](#).

For more information about hardware triggering, see Section 6.3.5 on [page 126](#) and Section 6.4.3 on [page 135](#).



**Frame Trigger Wait Signal Details (All Models Except acA1920-25um/uc, acA2500-14um/uc, acA3800-14um/uc, acA4600-10uc)**

When the camera is set for the timed exposure mode, the rise of the Frame Trigger Wait signal is based on the current ExposureTime parameter setting and on when readout of the current frame will end. This functionality is illustrated in Figure 76.

If you are operating the camera in the timed exposure mode, you can avoid overtriggering by always making sure that the Frame Trigger Wait signal is high before you trigger the start of frame capture.

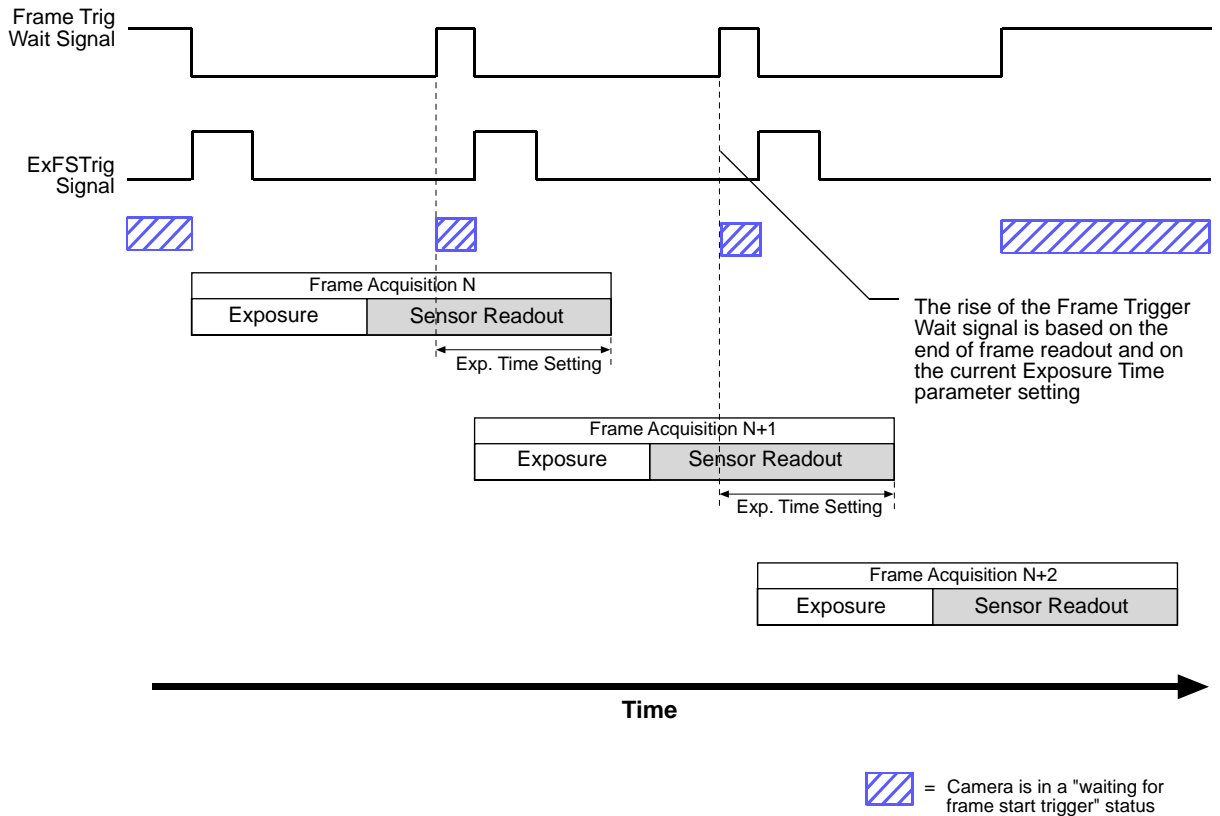

Fig. 76: Frame Trigger Wait Signal with the Timed Exposure Mode

When the camera is set for the trigger width exposure mode, you can avoid overtriggering by monitoring the rise of the Frame Trigger Wait signal. It is based on the Exposure Overlap Time Max parameter setting and on when readout of the current frame will end. This functionality is illustrated in Figure 77.

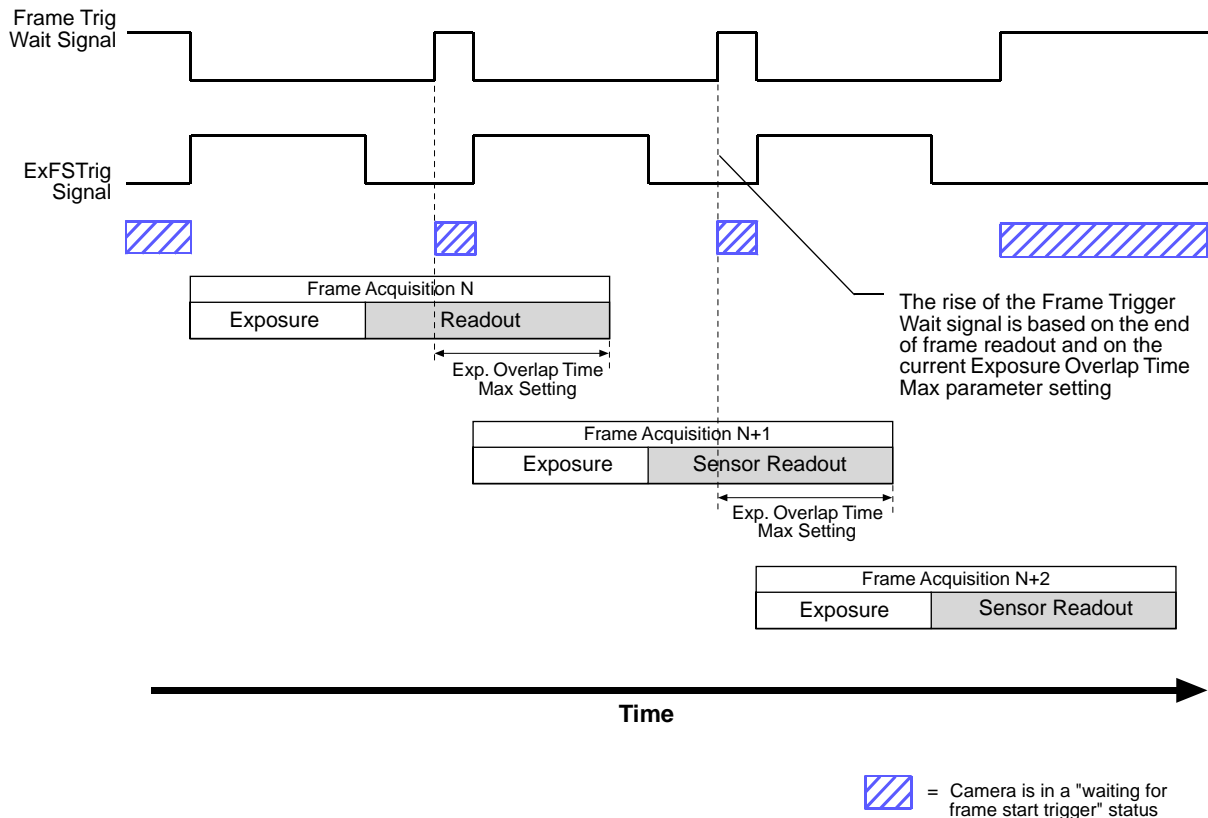

Fig. 77: Frame Trigger Wait Signal with the Trigger Width Exposure Mode

For information about the Exposure Overlap Time Max parameter and its use in the context of exposure overlap time modes, see Section 6.4.3.2 on [page 136](#).

For more information about the electrical characteristics of camera output lines, see Section 5.8.1 on [page 77](#) and Section 5.9.4.1 on [page 84](#).

### Frame Trigger Wait Signal Details (acA1920-25um/uc, acA2500-14um/uc, acA3800-14um/uc, acA4600-10uc Only)

For cameras with a rolling shutter, the rise of the Frame Trigger Wait signal is based on the minimum time required between the end of exposure of the first line in a frame and the start of exposure for the first line in the following frame. This functionality is illustrated in Figure 78.

If you are operating a camera with a rolling shutter, you can avoid overtriggering by always making sure that the Frame Trigger Wait signal is high before you trigger the start of frame capture.

 acA3800-14 and acA4600-10 cameras allow overlapped frame acquisition only when they are triggered internally ("free run"), i.e. when Trigger Mode is set to Off for the Frame Burst Start trigger and for the Frame Start Trigger.

The rise of the Frame Trigger Wait signal is based on the minimum time (400 μs) required between the end of exposure for the first line in frame N and the start of exposure for the first line in Frame N+1

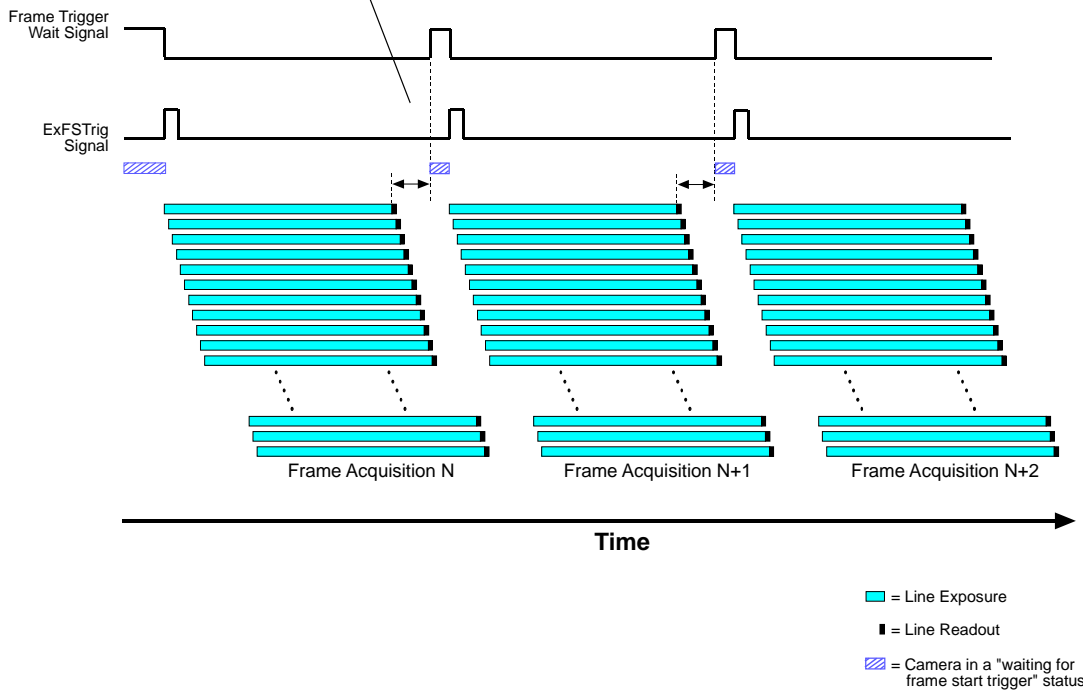

Fig. 78: Frame Trigger Wait Signal on a Rolling Shutter Camera

## Selecting the Frame Trigger Wait Signal as the Source Signal for an Output Line

The frame trigger wait signal can be selected to act as the source signal for a camera output line, e.g. Line 2. Selecting a source signal for an output line is a two step process:

- Use the Line Selector to select the output line, e.g. Line 2.
- Set the value of the Line Source Parameter to the frame trigger wait signal.

You can set the Line Selector and the Line Source parameter value from within your application software by using the Basler pylon API. The following code snippet illustrates using the API to set the selector and the parameter value:

```
camera.LineSelector.SetValue(LineSelector_Line2);  
camera.LineSource.SetValue(LineSource_FrameTriggerWait);
```

You can also use the Basler pylon Viewer application to easily set the parameters.

For more information about the pylon API and the pylon Viewer, see Section 3.1 on [page 62](#).

For more information about changing the selection of an output signal as the source signal for the output line, see Section 5.12.1 on [page 97](#).

For more information about the electrical characteristics of camera output lines, see Section 5.8.1 on [page 77](#) and Section 5.9.4.1 on [page 84](#).

## 6.8.5 Camera Events and Acquisition Status

Certain camera events allow you to get informed about the current camera acquisition status:

- EventFrameBurstStartWait event: The camera is waiting for a frame burst start trigger.
- EventFrameBurstStart event: A frame burst start trigger has occurred.
- EventFrameStartWait event: The camera is waiting for a frame start trigger.
- EventFrameStart event: A frame start trigger has occurred.
- EventExposureEnd event: The end of an exposure has occurred.

For more information about the camera events and event notification, see Section 7.17 on [page 319](#).

## 6.9 Acquisition Timing Chart

A timing chart for frame acquisition and transmission is given in [Figure 79](#). The chart assumes that exposure is triggered by an externally generated frame start trigger (ExFSTrig) signal with rising edge activation and that the camera is set for the timed exposure mode.

As can be seen from the timing chart, there is a slight delay between the rise of the ExFSTrig signal and the start of exposure. After the exposure time for a frame acquisition is complete, the camera begins reading out the acquired frame data from the imaging sensor and makes them available for transmission as called by the host computer.

The **exposure start delay** is the amount of time between the point where the trigger signal transitions and the point where exposure actually begins.

The exposure start delay varies from camera model to camera model. The table below shows the exposure start delay for each camera model (see [Table 40](#) on [page 181](#)).

The **sensor readout time** is the amount of time it takes to read out the data for an acquired frame from the imaging sensor.

The **frame transmission time** is the amount of time it takes to transmit an acquired frame from the camera to the host computer via the bus.

The frame transmission time can vary between frames and partly depends on when the host computer calls for data transmission.

The **transmission start delay** is the amount of time between the point where the camera begins reading out the acquired frame data from the sensor to the point where it begins transmitting the data for the acquired frame from the buffer to the host computer.

The transmission start delay can vary between frames and largely depends on when the host computer starts calling for data transmission.

Note that a **propagation delay** of unspecified duration precedes the exposure start delay when applying an ExFSTrig signal. For more information about propagation delays, see [Section 5.10](#) on [page 86](#).

| Camera Model     | Frame Acquisitions Not Overlapped   |        | Frame Acquisitions Overlapped                                |
|------------------|---|--------|--|
|                  | Exposure Start Delay [ $\mu$ s]   |        | Exposure Start Delay With Maximum Jitter Included [ $\mu$ s] |
|                  | 8 bit   | 12 bit |  |
| acA640-90um/uc   | 22  |        |  |
| acA640-120um/uc  | 18  |        |  |
| acA640-750um/uc  | 3.6   |        | 8.4  |
| acA800-510um/uc  | 3.6   |        | 8.4  |
| acA1300-30um/uc  | 35  |        |  |
| acA1300-200um/uc | 3.6   |        | 8.4  |
| acA1600-20um/uc  | 46  |        |  |
| acA1920-25um/uc  | 35  |        |  |
| acA1920-40um/uc  | 58  | 75     | N/A  |
| acA1920-150um/uc | 3.4   |        | 13.5   |
| acA1920-155um/uc | 17  | 21     | N/A  |
| acA2000-165um/uc | 0.9 to 1.3*   |        | 0.9 to 20.3*   |
| acA2000-165umNIR | 0.9 to 1.3*   |        | 0.9 to 20.3*   |
| acA2040-55um/uc  | 36  |        | N/A  |
| acA2040-90um/uc  | 0.9 to 1.3*   |        | 0.9 to 20.3*   |
| acA2040-90umNIR  | 0.9 to 1.3*   |        | 0.9 to 20.3*   |
| acA2040-120um/uc | 15  | 18     | N/A  |
| acA2440-35um/uc  | 42  |        | N/A  |
| acA2440-75um/uc  | 18  | 21     | N/A  |
| acA2500-14um/uc  | 848 (also for global reset release mode)  |        | 848 to 883   |
| acA2500-60u      | 3.4   |        | 13.5   |
| acA3800-14um/uc  | 2970 for mono cameras, 2620 for color cameras; (also for global reset release mode) |        |  |
| acA4600-10uc     | 7855 (also for global reset release mode)   |        |  |

Table 40: Exposure Start Delays for all Pixel Format Bit Depths Unless Indicated Otherwise

\* The shortest delays apply when maximum bandwidth is available. The delays increase as available bandwidth decreases.

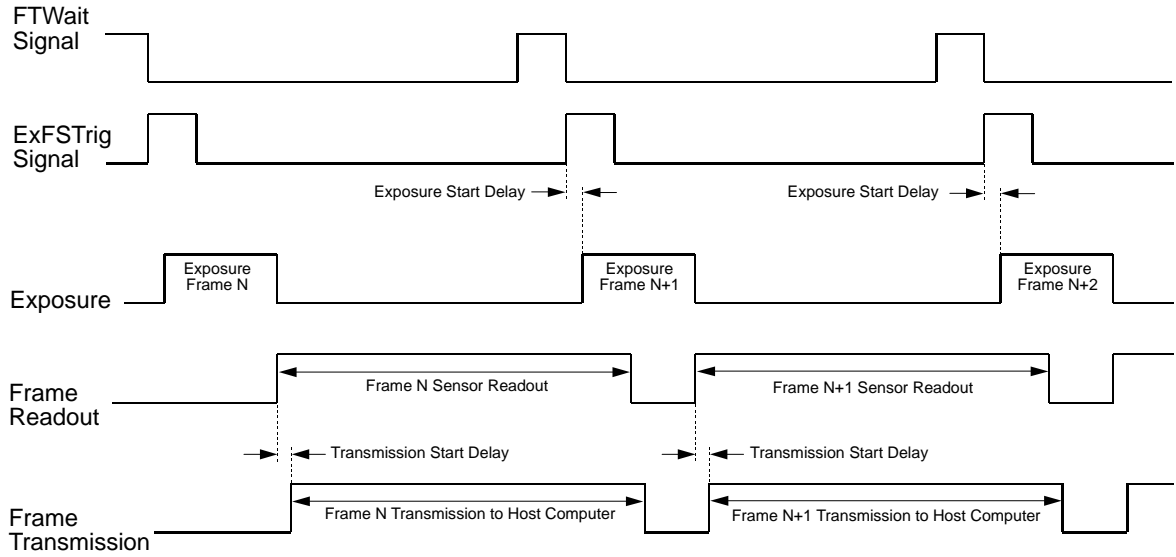

Timing charts are not drawn to scale

Fig. 79: Exposure Start Controlled with an ExFSTrig Signal

Note that you may have to add additional delays to the exposure start delay:

- If you use a hardware signal to trigger image acquisition, you must add a delay due to the input line response time (for input line Line 1 or the GPIO lines Line 3, Line 4, if configured for input). Note that such delays are associated with the frame burst start trigger signal and the frame start trigger signal.
- If you use the debouncer feature, you must add the delay due to the debouncer setting. For more information about the debouncer feature, see Section 5.11.2 on [page 94](#).
- If you have set a frame start trigger delay, you must add the set delay. For more information about the frame start trigger delay, see Section 6.4.3.3 on [page 143](#).

For example, assume that you are using an acA640-120 camera and that you have set the camera for hardware triggering. Also assume that you have selected input line Line 1 to accept the hardware trigger signal, that the input line response time is 1.5  $\mu\text{s}$ , that the delay due to the debouncer setting for input line Line 1 is 5  $\mu\text{s}$ , and that you set the frame start trigger delay to 200  $\mu\text{s}$ .

In this case:

Total Start Delay =

= Exposure Start Delay (Table 40) + Input Line Response time + Debouncer Setting + Frame Start Trigger Delay

Total Start Delay = 18  $\mu\text{s}$  + 1.5  $\mu\text{s}$  + 5  $\mu\text{s}$  + 200  $\mu\text{s}$  = 224.5  $\mu\text{s}$

You can determine the sensor readout time by reading the value of the Sensor Readout Time parameter. The parameter indicates what the readout time will be in microseconds given the camera's current settings. You can read the Sensor Readout Time parameter value from within your application software by using the Basler pylon API. The following code snippet illustrates using the API to get the parameter value:

```
double d = camera.SensorReadoutTime.GetValue();
```

You can also use the Basler pylon Viewer application to easily get the parameter value.

For more information about the pylon API and the pylon Viewer, see Section 3.1 on [page 62](#).



## 6.10 Maximum Allowed Frame Rate

In general, the maximum allowed acquisition frame rate on any ace USB 3.0 camera can be limited by these factors:

- The exposure time for the acquisition of frames. If you use very long exposure times, you can acquire fewer frames per second.
- The amount of time it takes to read an acquired frame out of the imaging sensor and to prepare it for transmission out of the camera. The amount of time varies with the height of the frame. Frames with a smaller height take less time. The frame height is determined by the camera's ROI Height setting.
- The amount of time it takes to transmit an acquired frame from the camera to your host computer. The amount of time depends on the bandwidth assigned to the camera.
- If the global reset release shutter mode on acA1920-25um/uc, acA2500-14um/uc, acA3800-14um/uc, and acA4600-10uc cameras is selected, overlapped image acquisition is not possible. This decreases the camera's maximum allowed frame rate. For more information about the global reset release shutter mode, see the "Global Reset Release Mode" Section 6.6.2.2 on [page 154](#).

There are two ways for determining the maximum allowed acquisition frame rate with your current camera settings:

- You can use the online frame rate calculator found in the Support section of the Basler website (Support > Tools > Frame Rate Calculator): [www.baslerweb.com](http://www.baslerweb.com)
- You can use the Basler pylon API to read the value of the camera's Resulting Frame Rate parameter (see the next page).

For more information about Image ROI Height settings, see Section 7.6 on [page 213](#).



When the camera's acquisition mode is set to Single Frame, the maximum possible acquisition frame rate for a given ROI cannot be achieved. This results because the camera performs a complete internal setup cycle for each single frame and

because it cannot be operated with overlapping sensor readout and exposure ("overlapped acquisition").

To achieve the maximum possible acquisition frame rate, set the camera for the continuous acquisition mode and use overlapped acquisition.

For more information about overlapped acquisition, see Section 6.7 on [page 161](#).



Factory parameter settings for acA2000-165u and acA2040-90u cameras will initially cause them to operate at less than their maximum specified frame rates:

- acA2000-165u: approximately 90 fps
- acA2040-90u: approximately 50 fps.

The factory parameter settings were chosen to avoid problems that might result from insufficient USB 3.0 bandwidth available in your application.

You can easily change the parameter settings to operate the cameras at the maximum specified frame rates when sufficient USB 3.0 bandwidth is available.

## 6.10.1 Using Basler pylon to Check the Maximum Allowed Frame Rate

You can use the Basler pylon API to read the current value of the Resulting Frame Rate parameter from within your application software using the Basler pylon API. The following code snippet illustrates using the API to get the parameter value:

```
// Get the resulting frame rate
double d = camera.ResultingFrameRate.GetValue();
```

The Resulting Frame Rate parameter takes all camera settings that can influence the frame rate into account and indicates the maximum allowed frame rate given the current settings.

You can also use the Basler pylon Viewer application to easily read the parameter.

For more information about the pylon API and pylon Viewer, see Section 3.1 on [page 62](#).

## 6.10.2 Increasing the Maximum Allowed Frame Rate

You may find that you would like to acquire frames at a rate higher than the maximum allowed with the camera's current settings. In this case, you must adjust one or more of the factors that can influence the maximum allowed rate and then check to see if the maximum allowed rate has increased:

- Decreasing the height of the Image ROI can have a significant impact on the maximum allowed frame rate. If possible in your application, decrease the height of the Image ROI.
- If you are using normal exposure times and you are using the camera at its maximum resolution, your exposure time will not normally restrict the frame rate. However, if you are using long exposure times or small regions of interest, it is possible that your exposure time is limiting the maximum allowed frame rate. If you are using a long exposure time or a small ROI, try using a shorter exposure time and see if the maximum allowed frame rate increases. (You may need to compensate for a lower exposure time by using a brighter light source or increasing the opening of your lens aperture.)
- The frame transmission time will not normally restrict the frame rate. But if you are using multiple cameras connected to one hub, you may find that the transmission time is restricting the maximum allowed rate. In this case, you could use a multiport host adapter in the computer instead of a hub.

If you are working with an **acA1920-25**, **acA2500-14**, **acA3800-14** or **acA4600-10** camera:

Use the rolling mode rather than the global reset release mode. The rolling mode allows overlapping frame acquisition while the global reset release mode does not. Overlapping frame acquisitions is, however, necessary for achieving the highest frame rates.

If you are working with an **acA640-750**, **acA800-510**, **acA1300-200**, **acA1920-150** or **acA2500-60** camera:

- Using the fast sensor readout mode instead of the normal sensor readout mode can increase the maximum allowed frame rate. For more information about sensor readout modes, see Section 6.6.1.1 on [page 150](#).
- You can increase the maximum allowed frame rate by decreasing the ROI width, provided the ROI width is above 256 pixels. For small ROIs less than 256 pixels wide, maximum allowed frame rate can not be decreased by decreasing the ROI width.



An important thing to keep in mind is a common mistake new camera users frequently make when they are working with exposure time. They will often use a very long exposure time without realizing that this can severely limit the camera's maximum allowed frame rate. As an example, assume that your camera is set to use a 1/2 second exposure time. In this case, because each frame acquisition will take at least 1/2 second to be completed, the camera will only be able to acquire a maximum of two frames per second. Even if the camera's nominal maximum frame rate is, for example, 100 frames per second, it will only be able to acquire two frames per second because the exposure time is set much higher than normal.

For more information about Image ROI settings, see Section 7.6 on [page 213](#).

For more information about the rolling mode, see Section 6.6.2 on [page 151](#).

## 6.11 Use Case Descriptions and Diagrams

The following pages contain a series of use case descriptions and diagrams. The descriptions and diagrams are designed to illustrate how frame burst start triggering and frame start triggering work in some common situations and with some common combinations of parameter settings.

These use cases do not represent every possible combination of the parameters associated with frame burst start and frame start triggering. They are simply intended to aid you in developing an initial understanding of how these two triggers interact.

In each use case diagram, the black box in the upper left corner indicates how the parameters are set.



The use case diagrams are representational. They are not drawn to scale and are not designed to accurately describe precise camera timings.

### Use Case 1 - Frame Burst Start and Frame Start Triggers Both Off (Free Run)

Use case one is illustrated on [page 188](#).

In this use case, the Acquisition Mode parameter is set to Continuous. The Trigger Mode parameter for the frame burst start trigger and the Trigger Mode parameter for the frame start trigger are both set to off. The camera will generate all required frame burst start and frame start trigger signals internally. When the camera is set this way, it will constantly acquire images without any need for triggering by the user. This use case is commonly referred to as "free run".





The rate at which the camera will acquire images will be determined by the camera's Acquisition Frame Rate parameter unless the current camera settings result in a lower frame rate. If the Acquisition Frame Rate parameter is disabled, the camera will acquire frames at the maximum allowed frame rate.

Cameras are used in free run for many applications. One example is for aerial photography. A camera set for free run is used to capture a continuous series of images as an aircraft overflies an area. The images can then be used for a variety of purposes including vegetation coverage estimates, archaeological site identification, etc.

For more information about the Acquisition Frame Rate parameter, see Section 6.4.1.1 on [page 129](#).

**Use Case:** "Free Run" (Frame Burst Start Trigger Off and Frame Start Trigger Off)  
 The frame burst start trigger is off. The camera will generate frame burst start trigger signals internally with no action by the user.  
 The frame start trigger is off. The camera will generate frame start trigger signals internally with no action by the user.

**Settings:** Acquisition Mode = Continuous  
 Trigger Mode for the frame burst start trigger = Off  
 Trigger Mode for the frame start trigger = Off

- - - - = a trigger signal generated by the camera internally
-  = camera is waiting for a frame burst start trigger
-  = camera is waiting for a frame start trigger
-  = frame exposure and readout
-  = frame transmission

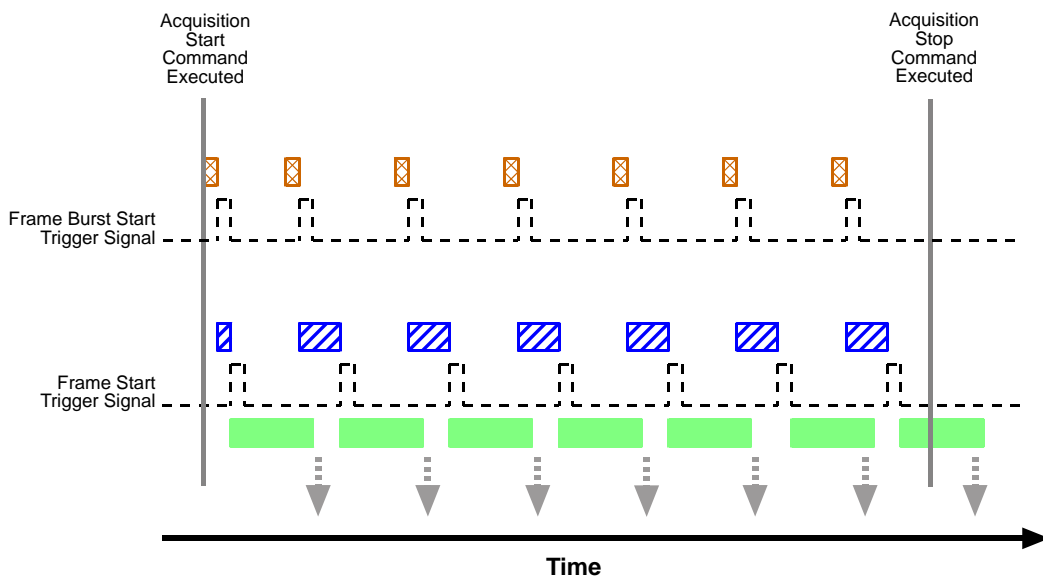

Fig. 80: Use Case 1 - Frame Burst Start Trigger Off and Frame Start Trigger Off

## Use Case 2 - Frame Burst Start Trigger Off - Frame Start Trigger On

Use case two is illustrated on [page 190](#).

In this use case, the Acquisition Mode parameter is set to Continuous. The Trigger Mode parameter for the frame burst start trigger is set to off and the Trigger Mode parameter for the frame start trigger is set to on.





Because the frame burst start trigger is set to off, the user does not need to apply frame burst start trigger signals to the camera. The camera generates all required frame burst start trigger signals internally.

Because the frame start trigger is set to on, the user must apply a frame start trigger signal to the camera in order to begin each frame exposure. In this case, we have set the frame start trigger signal source to input line Line 1 and the activation to rising edge, so the rising edge of an externally generated electrical signal applied to Line 1 will serve as the frame start trigger signal.

This type of camera setup is used frequently in industrial applications. One example might be a wood products inspection system used to inspect the surface of pieces of plywood on a conveyor belt as they pass by a camera. In this situation, a sensing device is usually used to determine when a piece of plywood on the conveyor is properly positioned in front of the camera. When the plywood is in the correct position, the sensing device transmits an electrical signal to input line 1 on the camera. When the electrical signal is received on line 1, it serves as a frame start trigger signal and initiates a frame acquisition. The frame acquired by the camera is forwarded to an image processing system, which will inspect the image and determine, if there are any defects in the plywood's surface.

**Use Case:** Frame Burst Start Trigger Off and Frame Start Trigger On  
 The frame burst start trigger is off. The camera will generate frame burst start trigger signals internally with no action by the user.  
 The frame start trigger is on, and the frame start trigger source is set to input line Line 1. The user must apply a frame start trigger signal to Line 1 to start each frame exposure.

**Settings:** Acquisition Mode = Continuous  
 Trigger Mode for the frame burst start trigger = Off  
 Trigger Mode for the frame start trigger = On  
 Trigger Source for the frame start trigger = Line 1  
 Trigger Activation for the frame start trigger = Rising Edge

- - - - = a trigger signal generated by the camera internally
- = a trigger signal applied by the user
-  = camera is waiting for a frame burst start trigger signal
-  = camera is waiting for a frame start trigger signal
-  = frame exposure and readout
-  = frame transmission

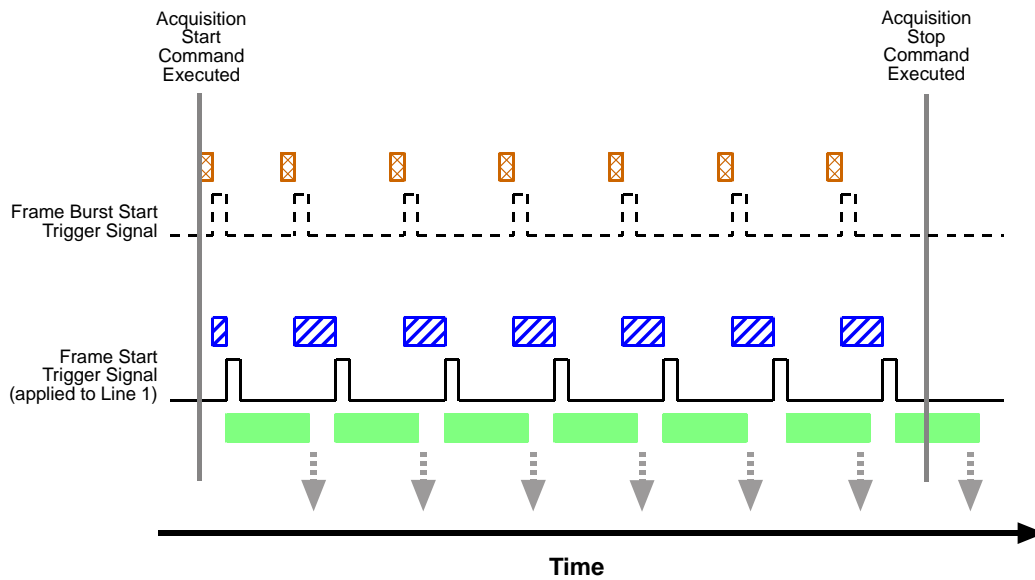

Fig. 81: Use Case 2 - Frame Burst Start Trigger Off and Frame Start Trigger On

### Use Case 3 - Frame Burst Start Trigger On - Frame Start Trigger Off

Use case three is illustrated on [page 192](#).

In this use case, the Acquisition Mode parameter is set to Continuous. The Trigger Mode parameter for the frame burst start trigger is set to on and the Trigger Mode parameter for the frame start trigger is set to off.

Because the frame burst start trigger mode is set to on, the user must apply a frame burst start trigger signal to the camera. In this case, we have set the frame burst start trigger signal source to input line Line 1 and the activation to rising edge, so an externally generated electrical signal applied to Line 1 will serve as the frame burst start trigger signal. The Acquisition Burst Frame Count parameter has been set to 3.

When a rising edge of the electrical signal is applied to Line 1, the camera will exit the "waiting for frame burst start trigger" acquisition status and enter a "waiting for frame start trigger" acquisition status. Once the camera has acquired 3 frames, it will re-enter the "waiting for frame burst start trigger" acquisition status. Before any more frames can be acquired, a new rising edge must be applied to input line 1 to make the camera exit the "waiting for frame burst start trigger" acquisition status.

Because the frame start trigger is set to off, the user does not need to apply frame start trigger signals to the camera. The camera will generate all required frame start trigger signals internally. The rate at which the frame start trigger signals will be generated is normally determined by the camera's Acquisition Frame Rate parameter. If the Acquisition Frame Rate parameter is disabled, the camera will acquire frames at the maximum allowed frame rate.

This type of camera setup is used frequently in intelligent traffic systems. With these systems, a typical goal is to acquire several images of a car as it passes through a toll booth. A sensing device is usually placed at the start of the toll booth area. When a car enters the area, the sensing device applies an electrical signal to input line 1 on the camera. When the electrical signal is received on input line 1, it serves as a frame burst start trigger signal and the camera exits from the "waiting for frame burst start trigger" acquisition status and enters a "waiting for frame trigger" acquisition status. In our example, the next 3 frame start trigger signals internally generated by the camera would result in frame acquisitions. At that point, the number of frames acquired would be equal to the setting for the Acquisition Burst Frame Count parameter. The camera would return to the "waiting for frame burst start trigger" acquisition status and would no longer react to frame start trigger signals. It would remain in this condition until the next car enters the booth area and activates the sensing device.

This sort of setup is very useful for traffic system applications because multiple frames can be acquired with only a single frame burst start trigger signal and because frames will not be acquired when there are no cars passing through the booth (this avoids the need to store images of an empty toll booth area.)

For more information about the Acquisition Frame Rate parameter, see Section 6.3.1.1 on [page 120](#).



**Use Case:** Frame Burst Start Trigger On and Frame Start Trigger Off

The frame burst start trigger is on, and the frame burst start trigger source is set to input line Line 1. The user must apply a frame burst start trigger signal to Line 1 to make the camera exit the "waiting for frame burst start trigger" acquisition status. Because the acquisition burst frame count is set to 3, the camera will re-enter the "waiting for frame burst start trigger" acquisition status after 3 frames have been acquired.

The frame start trigger is off. The camera will generate frame start trigger signals internally with no action by the user.

**Settings:** Acquisition Mode = Continuous  
 Trigger Mode for the frame burst start trigger = On  
 Trigger Source for the frame burst start trigger = Line 1  
 Trigger Activation for the frame burst start trigger = Rising Edge  
 Acquisition Burst Frame Count = 3  
 Trigger Mode for the frame start trigger = Off

- - - - = a trigger signal generated by the camera internally
- = a trigger signal applied by the user
- ▨ = camera is waiting for a frame burst start trigger signal
- ▩ = camera is waiting for a frame start trigger signal
- = frame exposure and readout
- ⋮ = frame transmission

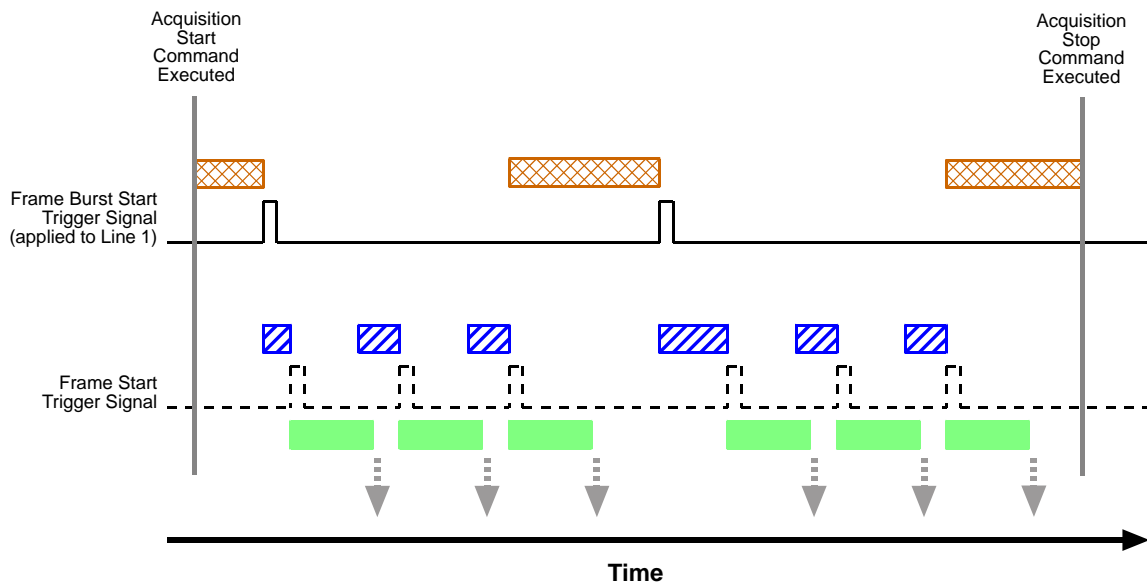

Fig. 82: Use Case 3 - Frame Burst Start Trigger On and Frame Start Trigger Off

## Use Case 4 - Frame Burst Start and Frame Start Triggers Both On

Use case four is illustrated on [page 194](#).

In this use case, the Acquisition Mode parameter is set to Continuous. The Trigger Mode parameter for the frame burst start trigger is set to on and the Trigger Mode parameter for the frame start trigger is set to on.

Because the frame burst start trigger mode is set to on, the user must apply a frame burst start trigger signal to the camera. In this case, we have set the frame burst start trigger signal source to software, so the execution of a frame burst trigger software command will serve as the frame burst start trigger signal. The Acquisition Burst Frame Count parameter is set to 3.

When a frame burst trigger software command is executed, the camera will exit the "waiting for frame burst start trigger" acquisition status and enter a "waiting for frame start trigger" acquisition status. Once the camera has acquired 3 frames, it will re-enter the "waiting for frame burst start trigger" acquisition status. Before any more frames can be acquired, a new frame burst trigger software command must be executed to make the camera exit the "waiting for frame burst start trigger" acquisition status.

Because the frame start trigger is set to on, the user must apply a frame start trigger signal to the camera in order to begin each frame acquisition. In this case, we have set the frame start trigger signal source to input line Line 1 and the activation to rising edge, so the rising edge of an externally generated electrical signal applied to input line Line 1 will serve as the frame start trigger signal. Keep in mind that the camera will only react to a frame start trigger signal when it is in a "waiting for frame start trigger" acquisition status.

A possible use for this type of setup is a conveyor system that moves objects past an inspection camera. Assume that the system operators want to acquire images of 3 specific areas on each object, that the conveyor speed varies, and that they do not want to acquire images when there is no object in front of the camera. A sensing device on the conveyor could be used in conjunction with a computer to determine when an object is starting to pass the camera. When an object is starting to pass, the computer will execute a frame burst start trigger software command, causing the camera to exit the "waiting for frame burst start trigger" acquisition status and enter a "waiting for frame start trigger" acquisition status.

An electrical device attached to the conveyor could be used to generate frame start trigger signals and to apply them to input line Line 1 on the camera. Assuming that this electrical device was based on a position encoder, it could account for the speed changes in the conveyor and ensure that frame trigger signals are generated and applied when specific areas of the object are in front of the camera. Once 3 frame start trigger signals have been received by the camera, the number of frames acquired would be equal to the setting for the Acquisition Burst Frame Count parameter, and the camera would return to the "waiting for frame burst start trigger" acquisition status. Any frame start trigger signals generated at that point would be ignored.

This sort of setup is useful because it will only acquire frames when there is an object in front of the camera and it will ensure that the desired areas on the object are imaged. (Transmitting images of the "space" between the objects would be a waste of bandwidth and processing them would be a waste of processor resources.)

**Use Case:** Frame Burst Start Trigger On and Frame Start Trigger On

The frame burst start trigger is on, and the frame burst start trigger source is set to software. The user must execute a frame burst start trigger software command to make the camera exit the "waiting for frame burst start trigger" acquisition status. Because the acquisition burst frame count is set to 3, the camera will re-enter the "waiting for frame burst start trigger" acquisition status after 3 frame start trigger signals have been applied.

The frame start trigger is on, and the frame start trigger source is set to input line Line 1. The user must apply a frame start trigger signal to input line Line 1 to start each frame exposure.

**Settings:** Acquisition Mode = Continuous  
 Trigger Mode for the frame burst start trigger = On  
 Trigger Source for the frame burst start trigger = Software  
 Acquisition Burst Frame Count = 3  
 Trigger Mode for the frame start trigger = On  
 Trigger Source for the frame start trigger = Line 1  
 Trigger Activation for the frame start trigger = Rising Edge

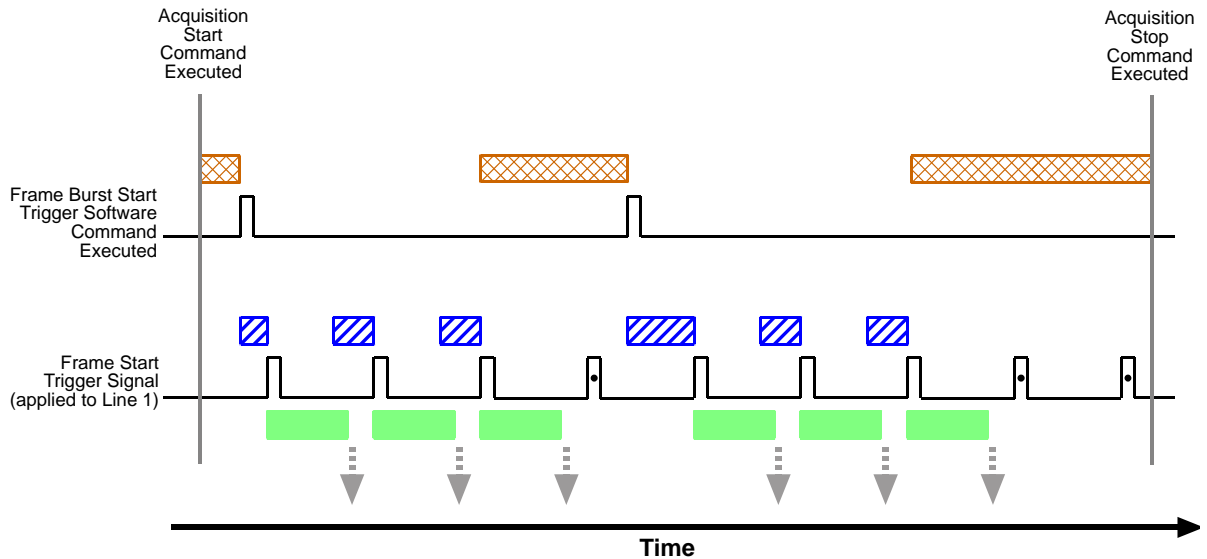
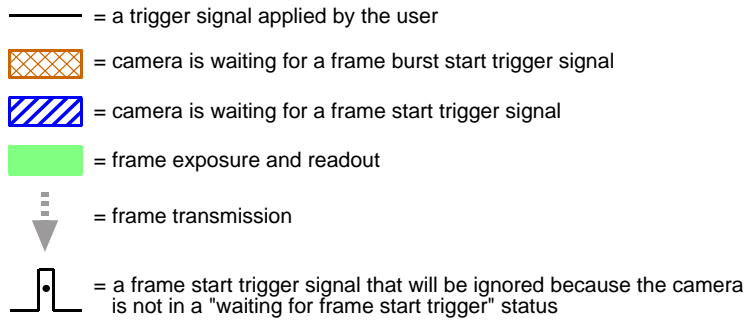

Fig. 83: Use Case 4 - Frame Burst Start Trigger On and Frame Start Trigger On

# 7 Features

This chapter provides detailed information about the features available on each camera. This chapter also includes explanations and how to operate the features and gives the associated parameters.

## 7.1 Feature Availability Charts

The feature availability charts below allow you to see at a glance which features are implemented on which camera model.

A solid bullet ( • ) indicates that a feature is implemented. A void space indicates that the pertinent feature is not implemented.

### Monochrome Cameras

| Camera Model | Feature |             |                         |               |                                |          |          |           |                    |                  |                       |                     |         |           |           |     |       |           |               |                    |                      |                    |            |                               |                     |           |                |            |
|--------------|---------|-------------|-------------------------|---------------|--------------------------------|----------|----------|-----------|--------------------|------------------|-----------------------|---------------------|---------|-----------|-----------|-----|-------|-----------|---------------|--------------------|----------------------|--------------------|------------|-------------------------------|---------------------|-----------|----------------|------------|
|              | Gain    | Black Level | Remove Parameter Limits | Digital Shift | Image Region of Interest (ROI) | Center X | Center Y | Sequencer | Binning Horizontal | Binning Vertical | Decimation Horizontal | Decimation Vertical | Scaling | Reverse X | Reverse Y | LUT | Gamma | Gain Auto | Exposure Auto | Balance White Auto | Pattern Removal Auto | Event Notification | Test Image | Device Information Parameters | User Defined Values | User Sets | Chunk Features | Line Pitch |

|                         |   |   |   |   |   |   |   |   |   |   |   |   |   |   |   |   |   |   |   |   |   |   |   |   |   |   |   |   |   |   |
|-------------------------|---|---|---|---|---|---|---|---|---|---|---|---|---|---|---|---|---|---|---|---|---|---|---|---|---|---|---|---|---|---|
| acA640-90um             | • | • | • | • | • | • | • | • | • | • |   |   |   | • |   | • | • | • | • |   |   | • | • | • | • | • | • |   |   |   |
| acA640-120um            | • | • | • | • | • | • | • | • | • | • |   |   |   | • |   | • | • | • | • | • |   |   | • | • | • | • | • | • |   |   |
| acA640-750um            | • | • | • |   | • | • | • | • | • | • |   |   |   | • | • | • | • | • | • | • |   |   | • | • | • | • | • | • |   |   |
| acA800-510um            | • | • | • |   | • | • | • | • | • | • |   |   |   | • | • | • | • | • | • | • |   |   | • | • | • | • | • | • |   |   |
| acA1300-30um            | • | • | • | • | • | • | • | • | • | • |   |   |   | • |   | • | • | • | • | • |   |   | • | • | • | • | • | • |   |   |
| acA1300-200um           | • | • | • |   | • | • | • | • | • | • |   |   |   | • | • | • | • | • | • | • |   |   | • | • | • | • | • | • |   |   |
| acA1600-20um            | • | • | • | • | • | • | • | • | • | • |   |   |   | • |   | • | • | • | • | • |   |   | • | • | • | • | • | • |   |   |
| acA1920-25um            | • | • | • | • | • | • | • | • | • | • |   |   |   | • |   | • | • | • | • | • |   |   | • | • | • | • | • | • |   |   |
| acA1920-40um            | • | • | • | • | • | • | • | • | • | • |   |   |   | • | • | • | • | • | • | • |   |   | • | • | • | • | • | • |   |   |
| acA1920-150um           | • | • | • |   | • | • | • | • | • | • |   |   |   | • | • | • | • | • | • | • |   |   | • | • | • | • | • | • |   |   |
| acA1920-155um           | • | • | • | • | • | • | • | • | • | • |   |   |   | • | • | • | • | • | • | • |   |   | • | • | • | • | • | • |   |   |
| acA2000-165um/<br>umNIR | • | • | • | • | • | • | • | • | • | • |   | • |   | • | • | • | • | • | • | • |   |   | • | • | • | • | • | • |   |   |
| acA2040-55um            | • | • | • | • | • | • | • | • | • | • |   |   |   | • | • | • | • | • | • | • |   |   | • | • | • | • | • | • |   |   |
| acA2040-90um/<br>umNIR  | • | • | • | • | • | • | • | • | • | • |   | • |   | • | • | • | • | • | • | • |   |   | • | • | • | • | • | • |   |   |
| acA2040-120um           | • | • | • | • | • | • | • | • | • | • |   |   |   | • | • | • | • | • | • | • |   |   | • | • | • | • | • | • |   |   |
| acA2440-35um            | • | • | • | • | • | • | • | • | • | • |   |   |   | • | • | • | • | • | • | • |   |   | • | • | • | • | • | • |   |   |
| acA2440-75um            | • | • | • | • | • | • | • | • | • | • |   |   |   | • | • | • | • | • | • | • |   |   | • | • | • | • | • | • |   |   |
| acA2500-14um            | • | • | • | • | • | • | • | • | • | • |   |   |   | • |   | • | • | • | • | • |   |   | • | • | • | • | • | • |   |   |
| acA2500-60um            | • | • | • |   | • | • | • | • | • | • |   |   |   | • | • | • | • | • | • | • |   |   | • | • | • | • | • | • |   |   |
| acA3800-14um            | • | • | • | • | • | • | • | • | • | • | • | • | • | • | • | • | • | • | • | • | • | • | • | • | • | • | • | • | • | • |

Table 41: Availability of Features in Monochrome Cameras

### Color Cameras

| Camera Model  | Feature |             |                         |               |                                |          |          |           |                    |                  |                       |                     |         |           |           |     |       |           |               |                    |                      |                    |            |                               |                     |           |                |            |                 |
|---------------|---------|-------------|-------------------------|---------------|--------------------------------|----------|----------|-----------|--------------------|------------------|-----------------------|---------------------|---------|-----------|-----------|-----|-------|-----------|---------------|--------------------|----------------------|--------------------|------------|-------------------------------|---------------------|-----------|----------------|------------|-----------------|
|               | Gain    | Black Level | Remove Parameter Limits | Digital Shift | Image Region of Interest (ROI) | Center X | Center Y | Sequencer | Binning Horizontal | Binning Vertical | Decimation Horizontal | Decimation Vertical | Scaling | Reverse X | Reverse Y | LUT | Gamma | Gain Auto | Exposure Auto | Balance White Auto | Pattern Removal Auto | Event Notification | Test Image | Device Information Parameters | User Defined Values | User Sets | Chunk Features | Line Pitch | PGI Feature Set |
| acA640-90uc   | •       | •           | •                       | •             | •                              | •        | •        | •         |                    |                  |                       |                     |         | •         |           | •   | •     | •         | •             | •                  |                      | •                  | •          | •                             | •                   | •         | •              | •          |                 |
| acA640-120uc  | •       | •           | •                       | •             | •                              | •        | •        | •         |                    |                  |                       |                     |         | •         |           | •   | •     | •         | •             | •                  | •                    |                    | •          | •                             | •                   | •         | •              | •          |                 |
| acA640-750uc  | •       | •           | •                       |               | •                              | •        | •        | •         |                    |                  |                       |                     |         | •         | •         | •   | •     | •         | •             | •                  | •                    |                    | •          | •                             | •                   | •         | •              | •          | •               |
| acA800-510uc  | •       | •           | •                       |               | •                              | •        | •        | •         |                    |                  |                       |                     |         | •         | •         | •   | •     | •         | •             | •                  | •                    |                    | •          | •                             | •                   | •         | •              | •          | •               |
| acA1300-30uc  | •       | •           | •                       | •             | •                              | •        | •        | •         |                    |                  |                       |                     |         | •         |           | •   | •     | •         | •             | •                  | •                    |                    | •          | •                             | •                   | •         | •              | •          |                 |
| acA1300-200uc | •       | •           | •                       |               | •                              | •        | •        | •         |                    |                  |                       |                     |         | •         | •         | •   | •     | •         | •             | •                  | •                    |                    | •          | •                             | •                   | •         | •              | •          | •               |
| acA1600-20uc  | •       | •           | •                       | •             | •                              | •        | •        | •         |                    |                  |                       |                     |         | •         |           | •   | •     | •         | •             | •                  | •                    |                    | •          | •                             | •                   | •         | •              | •          |                 |
| acA1920-25uc  | •       | •           | •                       | •             | •                              | •        | •        | •         | •                  | •                |                       |                     |         | •         |           | •   | •     | •         | •             | •                  | •                    |                    | •          | •                             | •                   | •         | •              | •          |                 |
| acA1920-40uc  | •       | •           | •                       | •             | •                              | •        | •        | •         |                    |                  |                       |                     |         | •         | •         | •   | •     | •         | •             | •                  | •                    |                    | •          | •                             | •                   | •         | •              | •          | •               |
| acA1920-150uc | •       | •           | •                       | •             | •                              | •        | •        | •         |                    |                  |                       |                     |         | •         | •         | •   | •     | •         | •             | •                  | •                    |                    | •          | •                             | •                   | •         | •              | •          | •               |
| acA1920-155uc | •       | •           | •                       | •             | •                              | •        | •        | •         |                    |                  |                       |                     |         | •         | •         | •   | •     | •         | •             | •                  | •                    |                    | •          | •                             | •                   | •         | •              | •          | •               |
| acA2000-165uc | •       | •           | •                       | •             | •                              | •        | •        | •         |                    |                  |                       | •                   |         | •         | •         | •   | •     | •         | •             | •                  | •                    |                    | •          | •                             | •                   | •         | •              | •          |                 |
| acA2040-55uc  | •       | •           | •                       | •             | •                              | •        | •        | •         |                    |                  |                       |                     |         | •         | •         | •   | •     | •         | •             | •                  | •                    |                    | •          | •                             | •                   | •         | •              | •          | •               |
| acA2040-90uc  | •       | •           | •                       | •             | •                              | •        | •        | •         |                    |                  |                       | •                   |         | •         | •         | •   | •     | •         | •             | •                  | •                    |                    | •          | •                             | •                   | •         | •              | •          |                 |
| acA2040-120uc | •       | •           | •                       | •             | •                              | •        | •        | •         |                    |                  |                       |                     |         | •         | •         | •   | •     | •         | •             | •                  | •                    |                    | •          | •                             | •                   | •         | •              | •          | •               |
| acA2440-35uc  | •       | •           | •                       | •             | •                              | •        | •        | •         |                    |                  |                       |                     |         | •         | •         | •   | •     | •         | •             | •                  | •                    |                    | •          | •                             | •                   | •         | •              | •          | •               |
| acA2440-75uc  | •       | •           | •                       | •             | •                              | •        | •        | •         |                    |                  |                       |                     |         | •         | •         | •   | •     | •         | •             | •                  | •                    |                    | •          | •                             | •                   | •         | •              | •          | •               |
| acA2500-14uc  | •       | •           | •                       | •             | •                              | •        | •        | •         | •                  | •                |                       |                     |         | •         |           | •   | •     | •         | •             | •                  | •                    |                    | •          | •                             | •                   | •         | •              | •          |                 |
| acA2500-60uc  | •       | •           | •                       |               | •                              | •        | •        | •         |                    |                  |                       |                     |         | •         | •         | •   | •     | •         | •             | •                  | •                    |                    | •          | •                             | •                   | •         | •              | •          | •               |
| acA3800-14uc  | •       | •           | •                       | •             | •                              | •        | •        | •         |                    |                  | •                     | •                   | •       | •         |           | •   | •     | •         | •             | •                  | •                    |                    | •          | •                             | •                   | •         | •              | •          |                 |
| acA4600-10uc  | •       | •           | •                       | •             | •                              | •        | •        | •         |                    |                  | •                     | •                   | •       | •         |           | •   | •     | •         | •             | •                  | •                    |                    | •          | •                             | •                   | •         | •              | •          |                 |

Table 42: Availability of Features in Color Cameras

## 7.2 Gain

For information about the availability of the gain feature on a specific camera model, see Table 41 on [page 196](#) and Table 42 on [page 197](#). If your camera model is without gain, use the digital shift feature to obtain a similar effect.

For more information about the digital shift feature, see Section 7.5 on [page 207](#).

The camera's gain feature allows to adjust the camera's gain. As shown in Figure 84, increasing the gain increases the slope of the response curve for the camera. This results in a higher gray value output from the camera for a given amount of output from the imaging sensor. Decreasing the gain decreases the slope of the response curve and results in a lower gray value for a given amount of sensor output.

Increasing the gain is useful when at your brightest exposure, a gray value lower than 255 (in modes that output 8 bits per pixel) or 4095 (in modes that output 12 bits per pixels) is reached. For example, if you found that at your brightest exposure the gray values output by the camera were no higher than 127 (in an 8 bit mode), you could increase the gain to 6 dB (an amplification factor of 2) and thus reach gray values of 254.

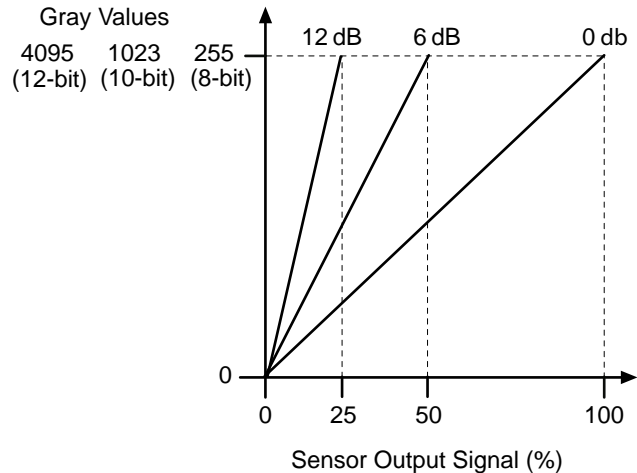

Fig. 84: Gain in dB, Shown for 8 bit, 10 bit, and 12 bit Output

### 7.2.1 Analog and Digital Control

Depending on the sensor and pixel format used, the mechanisms for GainAll control can vary: For some cameras, control is analog up to and including a certain boundary GainAll parameter value [dB] (see [Table 43](#)), above which GainAll control is digital. For some cameras, Gain All control is entirely digital, for others entirely analog.

The boundary GainAll parameter value is constant and independent of the chosen pixel format, of whether the parameter limits for Gain All are disabled, and of whether binning vertical is enabled.

For some camera models, the maximum allowed GainAll parameter value decreases when a pixel format with a higher bit depth is selected (see [Table 44](#)). Gain All control is entirely analog if the maximum allowed GainAll parameter value falls below the boundary GainAll parameter value.

| Camera Model           | Mechanism of GainAll Control | Boundary Gain All Parameter Value [dB]; GainAll Control Is Digital Above the Value |
|------------------------|------------------------------|--|
| acA640-90um/uc         | analog/digital               | 11.524   |
| acA640-120um/uc        | analog/digital               | 14.755   |
| acA640-750um/uc        | digital only                 | N/A  |
| acA800-510um/uc        | digital only                 | N/A  |
| acA1300-30um/uc        | analog/digital               | 7.575  |
| acA1300-200um/uc       | digital only                 | N/A  |
| acA1600-20um/uc        | analog/digital               | 10.1   |
| acA1920-25um/uc        | digital only                 | N/A  |
| acA1920-40um/uc        | analog/digital               | 24   |
| acA1920-150um/uc       | digital only                 | N/A  |
| acA1920-155um/uc       | analog/digital               | 24   |
| acA2000-165um/umNIR/uc | digital only                 | N/A  |
| acA2040-55um/uc        | analog/digital               | 24   |
| acA2040-90um/umNIR/uc  | digital only                 | N/A  |
| acA2040-120um/uc       | analog/digital               | 24   |
| acA2440-35um/uc        | analog/digital               | 24   |
| acA2440-75um/uc        | analog/digital               | 24   |
| acA2500-14um/uc        | digital only                 | N/A  |
| acA2500-60um/uc        | digital only                 | N/A  |
| acA3800-14um/uc        | digital only                 | N/A  |
| acA4600-10uc           | digital only                 | N/A  |

Table 43: Mechanisms of GainAll Control and Boundary Values (If Applicable)

For information about the digital shift feature, see Section 7.5 on [page 207](#).



## 7.2.2 Setting the Gain



This section (Section 7.2) describes how gain can be adjusted "manually", i.e., by setting the value of the gain All parameter.

The camera also has a Gain Auto function that can automatically adjust the gain. **"Manual" adjustment of the GainAll parameter will only work, if the Gain Auto function is disabled.** If the Gain Auto function is enabled the GainAll parameter will merely be in a "read only" state.

For more information about auto functions in general, see Section 7.15 on [page 299](#). For more information about the Gain Auto function, see Section 7.15.4 on [page 307](#).

The camera's gain is determined by the value of the GainAll parameter. The regular parameter value is adjusted on a scale ranging from zero to a maximum value. The minimum regular value depends on whether vertical binning is enabled (see [Table 44](#)). The maximum allowed parameter value can depend on whether the camera is set for a pixel format that yields an effective pixel bit depth of 8 bit per pixel (e.g. Mono 8, RGB 8, Bayer BG 8, YCbCr422\_8), of 10 bit (e.g. Mono 10, Mono 10 p, Bayer BG 10, Bayer BG 10 p) or of 12 bit (e.g. Mono 12, Mono 12 p, Bayer BG 12, Bayer BG 12 p).

Table 44 shows the minimum and maximum settable gain for each camera model. The values indicate regular settings, i.e. the parameter limits are not removed.

| Camera Model           | GainAll Parameter Values [dB] |  |                           |                            |                            |
|------------------------|-------------------------------|--|---------------------------|----------------------------|----------------------------|
|                        | Min Regular                   | Min Regular with Vertical Binning (Mono Cameras) | Max Allowed (8 bit depth) | Max Allowed (10 bit depth) | Max Allowed (12 bit depth) |
| acA640-90um/uc         | 0.0                           | -3.231   | 29.9047                   | N/A                        | 7.539                      |
| acA640-120um/uc        | 0.0                           | 0.0  | 33.1357                   | N/A                        | 17.95                      |
| acA640-750um/uc        | 0.0                           | 0.0  | 12.0                      | 12.0                       | N/A                        |
| acA800-510um/uc        | 0.0                           | 0.0  | 12.0                      | 12.0                       | N/A                        |
| acA1300-30um/uc        | 0.0                           | -3.59  | 19.745                    | N/A                        | 3.59                       |
| acA1300-200um/uc       | 0.0                           | 0.0  | 12.0                      | 12.0                       | N/A                        |
| acA1600-20um/uc        | 0.0                           | -3.59  | 22.258                    | N/A                        | 6.103                      |
| acA1920-25um/uc        | 0.0                           | 0.0  | 23.79814                  | N/A                        | 23.79814                   |
| acA1920-40um/uc        | 0.0                           | 0.0  | 36.0                      | N/A                        | 24.0                       |
| acA1920-150um/uc       | 0.0                           | 0.0  | 12.0                      | 12.0                       | N/A                        |
| acA1920-155um/uc       | 0.0                           | 0.0  | 36.0                      | N/A                        | 24.0                       |
| acA2000-165um/umNIR/uc | 0.0                           | 0.0  | 23.5935                   | N/A                        | 23.5935                    |
| acA2040-55um/uc        | 0.0                           | 0.0  | 36                        | N/A                        | 24                         |
| acA2040-90um/umNIR/uc  | 0.0                           | 0.0  | 23.5935                   | N/A                        | 23.5935                    |
| acA2040-120um/uc       | 0.0                           | 0.0  | 36                        | N/A                        | 24                         |
| acA2440-35um/uc        | 0.0                           | 0.0  | 36                        | N/A                        | 24                         |
| acA2440-75um/uc        | 0.0                           | 0.0  | 36                        | N/A                        | 24                         |
| acA2500-14um/uc        | 0.0                           | 0.0  | 23.79814                  | N/A                        | 23.79814                   |
| acA2500-60um/uc        | 0.0                           | 0.0  | 12.0                      | 12.0                       | N/A                        |
| acA3800-14um/uc        | 0.0                           | 0.0  | 16.67569                  | N/A                        | 16.67569                   |
| acA4600-10uc           | 0.0                           | N/A  | 17.76052                  | N/A                        | 17.76052                   |

Table 44: Minimum and Maximum Gain All Parameter Values (Parameter Limits Not Removed)

**To set the Gain parameter value using Basler pylon:**

1. Set the Gain Selector to All.
2. Set the Gain parameter to your desired value.

You can set the Gain Selector and the GainAll parameter value from within your application software by using the Basler pylon API. The following code snippet illustrates using the API to set the selector and the parameter value:

```
camera.GainSelector.SetValue(GainSelector_All);  
camera.Gain.SetValue(0.0359);
```

You can also use the Basler pylon Viewer application to easily set the parameters. For more information about the pylon API and the pylon Viewer, see Section 3.1 on [page 62](#).



The minimum **regular** setting for the GainAll parameter is the minimum setting that applies when the remove parameter limits feature is not used.

The minimum setting for the GainAll parameter can be decreased from the regular setting to negative values by using the remove parameter limits feature.

For more information about the remove parameter limits feature, see Section 7.4 on [page 206](#).

## 7.3 Black Level

For information about the availability of the black level feature on a specific camera model, see Table 41 on [page 196](#) and Table 42 on [page 197](#).

Adjusting the camera's black level will result in an offset to the pixel values output by the camera. Increasing the black level setting will result in a positive offset in the pixel values output for the pixels. Decreasing the black level setting will result in a negative offset in the pixel values output for the pixels.

For example, if the black level parameter value is increased by 1 the pixel value for each pixel is increased by 1. If the black level parameter value is decreased by 1 the pixel value for each pixel is decreased by 1.

## 7.3.1 Setting the Black Level

The black level can be adjusted by changing the value of the Black Level parameter.

The range of the allowed settings for the Black Level parameter value in DN varies by camera model as shown in [Table 45](#).

| Camera Model           | Black Level Setting |                              |   |
|------------------------|---------------------|------------------------------|---|
|                        | Min Allowed         | Max Allowed<br>(8 bit depth) | Max Allowed<br>(10 bit or 12 bit depth) |
| acA640-90um/uc         | 0.0                 | 15.98438                     | 255.75                                  |
| acA640-120um/uc        | 0.0                 | 15.98438                     | 255.75                                  |
| acA640-750um/uc        | 0.0                 | 63.75                        | 255.0                                   |
| acA800-510um/uc        | 0.0                 | 63.75                        | 255.0                                   |
| acA1300-30um/uc        | 0.0                 | 15.98438                     | 255.75                                  |
| acA1300-200um/uc       | 0.0                 | 63.75                        | 255.0                                   |
| acA1600-20um/uc        | 0.0                 | 15.98438                     | 255.75                                  |
| acA1920-25um/uc        | 0.0                 | 15.9375                      | 255.0                                   |
| acA1920-40um/uc        | 0.0                 | 31.9375                      | 511.0                                   |
| acA1920-150um/uc       | 0.0                 | 63.75                        | 255.0                                   |
| acA1920-155um/uc       | 0.0                 | 31.9375                      | 511.0                                   |
| acA2000-165um/umNIR/uc | 0.0                 | 15.9375                      | 255.0                                   |
| acA2040-55um/uc        | 0.0                 | 31.9375                      | 511.0                                   |
| acA2040-90um/umNIR/uc  | 0.0                 | 15.9375                      | 255.0                                   |
| acA2040-120um/uc       | 0.0                 | 31.9375                      | 511.0                                   |
| acA2440-35um/uc        | 0.0                 | 31.9375                      | 511.0                                   |
| acA2440-75um/uc        | 0.0                 | 31.9375                      | 511.0                                   |
| acA2500-14um/uc        | 0.0                 | 15.9375                      | 255.0                                   |
| acA2500-60um/uc        | 0.0                 | 63.75                        | 255.0                                   |
| acA3800-14um/uc        | 0.0                 | 63.9375                      | 1023                                    |
| acA4600-10uc           | 0.0                 | 63.9375                      | 1023                                    |

Table 45: Minimum and Maximum Black Level Settings ([DN])

**To set the Black Level parameter value using Basler pylon:**

1. Set the Black Level Selector to All.
2. Set the Black Level parameter to your desired value.

You can set the Black Level Selector and the Black Level parameter value from within your application software by using the Basler pylon API. The following code snippet illustrates using the API to set the selector and the parameter value:

```
camera.BlackLevelSelector.SetValue(BlackLevelSelector_All);  
camera.BlackLevel.SetValue(1.0);
```

You can also use the Basler pylon Viewer application to easily set the parameters.

For more information about the pylon API and the pylon Viewer, see Section 3.1 on [page 62](#).

## 7.4 Remove Parameter Limits

For each camera feature, the allowed range of any associated parameter values is normally limited. The factory limits are designed to ensure optimum camera operation and, in particular, good image quality. For special camera uses, however, it may be helpful to set parameter values outside of the factory limits.

The remove parameter limits feature lets you remove the factory limits for parameters associated with certain camera features. When the factory limits are removed, the parameter values can be set within extended limits. Typically, the range of the extended limits is dictated by the physical restrictions of the camera's electronic devices, such as the absolute limits of the camera's variable gain control.

The values for any extended limits can be determined by using the Basler pylon Viewer or from within your application via the pylon API.

Parameter limits can be removed for the following parameters:

- All parameter for setting gain (remove parameter limits generally available)
- ExposureTime (remove parameter limits available for some camera models)

Removing the parameter limits on the gain feature will only remove the lower regular limit. When the lower regular limit is removed the gain All parameter value can be decreased to a negative value.

For more information about the gain feature, see Section 7.2 on [page 198](#).

### Removing Parameter Limits

#### To remove the limits for a parameter value:

1. Use the Parameter Limits Selector to select the parameter whose limits you want to remove.
2. Set the value of the Remove Parameter Limits parameter.

You can set the Parameter Limits Selector and the value of the Remove Parameter Limits parameter from within your application software by using the Basler pylon API. The following code snippet illustrates using the API to set the selector and the parameter value:

```
// Select the feature whose factory limits will be removed.
camera.RemoveParameterLimitSelector.SetValue(RemoveParameterLimitSelector_Gain);
// Remove the limits for the selected feature.
camera.RemoveParameterLimit.SetValue(true);
```

You can also use the Basler pylon Viewer application to easily set the parameters. Note that the remove parameter limits feature will only be available at the "guru" viewing level.

For more information about the pylon API and the pylon Viewer, see Section 3.1 on [page 62](#).

## 7.5 Digital Shift

For information about the availability of digital shift on a specific camera model, see Table 41 on [page 196](#) and Table 42 on [page 197](#).

The digital shift feature lets you change the groups of bits that are output from the ADCs in the camera. Using the digital shift feature will effectively multiply the output of the camera by 2 times, 4 times, 8 times, or 16 times. The next two sections describe how the digital shift feature works when the camera is set for a 12 bit pixel format and when it is set for a 8 bit pixel format. There is also a section describing precautions that you must observe when using the digital shift feature and a section that describes enabling and setting the digital shift feature.



If the digital shift feature is not available for your camera you can use the gain feature to obtain an effect similar to adjusting digital shift.

For more information about the gain feature, see Section 7.2 on [page 198](#).

### 7.5.1 Digital Shift with 12 Bit Pixel Formats

#### No Shift

As mentioned in the Functional Description section of this manual, the camera uses 12 bit ADCs to digitize the output from the imaging sensor. When the camera is set for a pixel format that outputs pixel data at 12 bit effective depth, by default, the camera transmits the 12 bits that are output from the ADC.

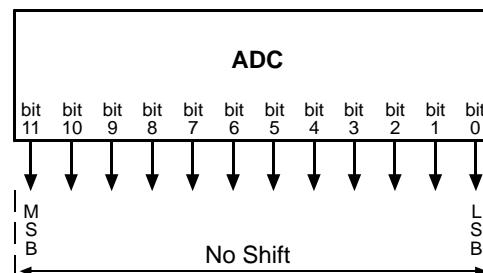

#### Shift by 1

When the camera is set to shift by 1, the output from the camera will include bit 10 through bit 0 from the ADC along with a zero as an LSB.

The result of shifting once is that the output of the camera is effectively multiplied by 2. For example, assume that the camera is set for no shift, that it is viewing a uniform white target, and that under these conditions the reading for the brightest pixel is 100. If you changed the digital shift setting to shift by 1, the reading would increase to 200.

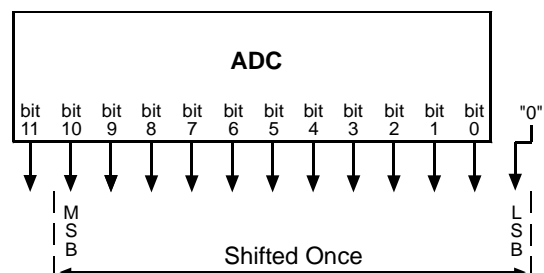



When the camera is set to shift by 1, the least significant bit output from the camera for each pixel value will be 0. This means that no odd gray values can be output and that the gray value scale will only include values of 2, 4, 6, 8, 10, and so on. This absence of some gray values is commonly referred to as "missing codes".

If the pixel values being output by the camera's sensor are high enough to set bit 11 to 1, we recommend not using shift by 1. If you do nonetheless, all bits output from the camera will automatically be set to 1. Therefore, you should only use the shift by 1 setting when your pixel readings with a 12 bit pixel format selected and with digital shift disabled are all less than 2048.

### Shift by 2

When the camera is set to shift by 2, the output from the camera will include bit 9 through bit 0 from the ADC along with 2 zeros as LSBs.

The result of shifting twice is that the output of the camera is effectively multiplied by 4.

When the camera is set to shift by 2, the 2 least significant bits output from the camera for each pixel value will be 0. This means that the gray value scale will only include every 4th value, for example, 4, 8, 16, 20, and so on.

If the pixel values being output by the camera's sensor are high enough to set bit 10 or bit 11 to 1, we recommend not using shift by 2. If you do nonetheless, all bits output from the camera will automatically be set to 1. Therefore, you should only use the shift by 2 setting when your pixel readings with a 12 bit pixel format selected and with digital shift disabled are all less than 1024.

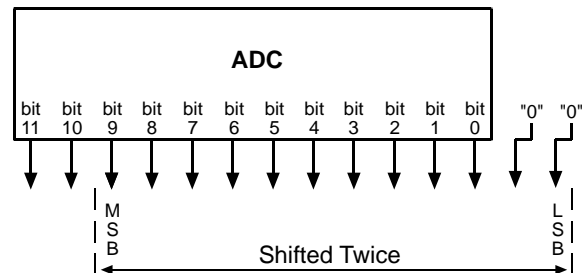

### Shift by 3

When the camera is set to shift by 3, the output from the camera will include bit 8 through bit 0 from the ADC along with 3 zeros as LSBs.

The result of shifting 3 times is that the output of the camera is effectively multiplied by 8.

When the camera is set to shift by 3, the 3 least significant bits output from the camera for each pixel value will be 0. This means that the gray value scale will only include every 8th gray value, for example, 8, 16, 24, 32, and so on.

If the pixel values being output by the camera's sensor are high enough to set bit 9, bit 10, or bit 11 to 1, we recommend not using shift by 3. If you do nonetheless, all bits output from the camera will automatically be set to 1. Therefore, you should only use the shift by 3 setting when your pixel readings with a 12 bit pixel format selected and with digital shift disabled are all less than 512.

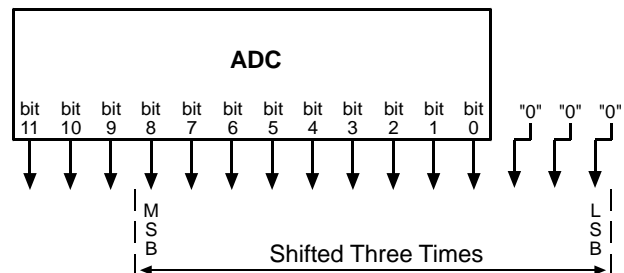

### Shift by 4

When the camera is set to shift by 4, the output from the camera will include bit 7 through bit 0 from the ADC along with 4 zeros as LSBs.

The result of shifting 4 times is that the output of the camera is effectively multiplied by 16.

When the camera is set to shift by 4, the 4 least significant bits output from the camera for each pixel value will be 0. This means that the gray value scale will only include every 16th gray value, for example, 16, 32, 48, 64, and so on.

If the pixel values being output by the camera's sensor are high enough to set bit 8, bit 9, bit 10, or bit 11 to 1, we recommend not using shift by 4. If you do nonetheless, all bits output from the camera will automatically be set to 1. Therefore, you should only use the shift by 4 setting when your pixel readings with a 12 bit pixel format selected and with digital shift disabled are all less than 256.

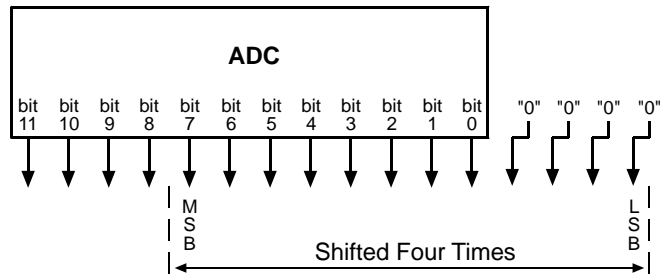

## 7.5.2 Digital Shift with 8 Bit Pixel Formats

### No Shift

As mentioned in the Functional Description section of this manual, the camera uses a 12 bit ADC to digitize the output from the imaging sensor. When the camera is set for a pixel format that outputs pixel data at 8 bit effective depth, by default, the camera drops the 4 least significant bits from the ADC and transmits the 8 most significant bits (bit 11 through 4).

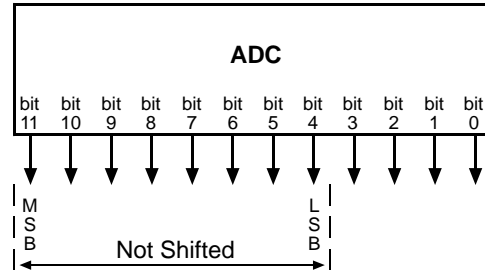

### Shift by 1

When the camera is set to shift by 1, the output from the camera will include bit 10 through bit 3 from the ADC.

The result of shifting once is that the output of the camera is effectively multiplied by 2. For example, assume that the camera is set for no shift, that it is viewing a uniform white target, and that under these conditions the reading for the brightest pixel is 10. If you changed the digital shift setting to shift by 1, the reading would increase to 20.

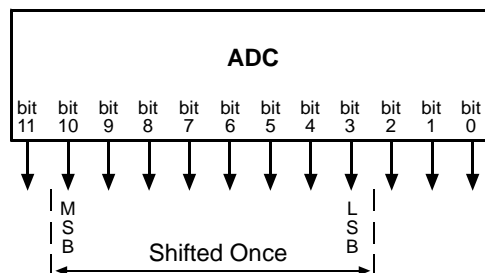

If the pixel values being output by the camera's sensor are high enough to set bit 11 to 1, we recommend not using shift by 1. If you do nonetheless, all bits output from the camera will

automatically be set to 1. Therefore, you should only use the shift by 1 setting when your pixel readings with an 8 bit pixel format selected and with digital shift disabled are all less than 128.

### Shift by 2

When the camera is set to shift by 2, the output from the camera will include bit 9 through bit 2 from the ADC.

The result of shifting twice is that the output of the camera is effectively multiplied by 4.

If the pixel values being output by the camera's sensor are high enough to set bit 10 or bit 11 to 1, we recommend not using shift by 2. If you do nonetheless, all bits output from the camera will automatically be set to 1. Therefore, you should only use the shift by 2 setting when your pixel readings with an 8 bit pixel format selected and with digital shift disabled are all less than 64.

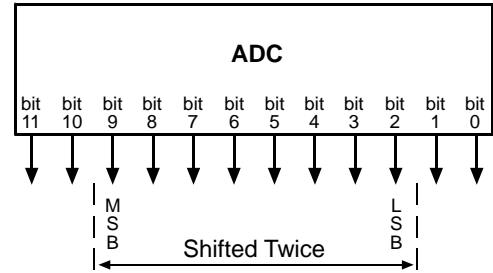

### Shift by 3

When the camera is set to shift by 3, the output from the camera will include bit 8 through bit 1 from the ADC.

The result of shifting three times is that the output of the camera is effectively multiplied by 8.

If the pixel values being output by the camera's sensor are high enough to set bit 9, bit 10, or bit 11 to 1, we recommend not using shift by 3. If you do nonetheless, all bits output from the camera will automatically be set to 1. Therefore, that you should only use the shift by 3 setting when your pixel readings with an 8 bit pixel format selected and with digital shift disabled are all less than 32.

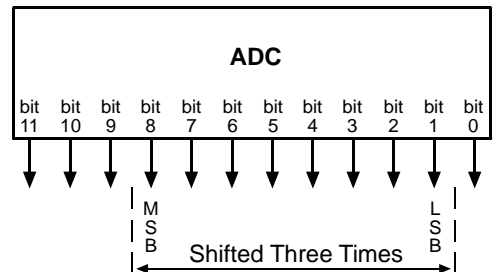

### Shift by 4

When the camera is set to shift by 4, the output from the camera will include bit 7 through bit 0 from the ADC.

The result of shifting four times is that the output of the camera is effectively multiplied by 16.

If the pixel values being output by the camera's sensor are high enough to set bit 8, bit 9, bit 10, or bit 11 to 1, we recommend not using shift by 4. If you do nonetheless, all bits output from the camera will automatically be set to 1. Therefore, you should only use the multiply by 4 setting when your pixel readings with an 8 bit pixel format selected and with digital shift disabled are all less than 16.

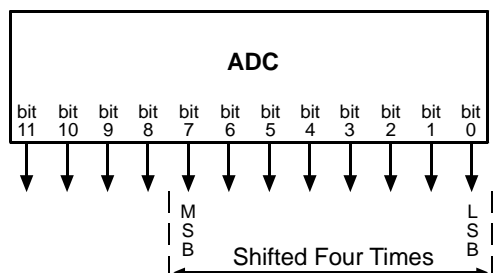

## 7.5.3 Precautions When Using Digital Shift

There are several checks and precautions that you must follow before using the digital shift feature. The checks and precautions differ depending on whether the camera will be set for a 12 bit pixel format or for an 8 bit pixel format in your application.

If you will be using a 12 bit pixel format, make this check:

Use the pylon Viewer or the pylon API to set the camera for a 12 bit pixel format and **no digital shift**.

Check the output of the camera under your normal lighting conditions and note the readings for the brightest pixels.

- If any of the readings are above 2048, do not use digital shift.
- If all of the readings are below 2048, you can safely use the shift by 1 setting.
- If all of the readings are below 1024, you can safely use the shift by 1 or 2 settings.
- If all of the readings are below 512, you can safely use the shift by 1, 2, or 3 settings.
- If all of the readings are below 256, you can safely use the shift by 1, 2, 3, or 4 settings.

If you will be using an 8 bit format, make this check:

Use the pylon Viewer or the pylon API to set the camera for a 8 bit pixel format and **no digital shift**.

Check the output of the camera under your normal lighting conditions and note the readings for the brightest pixels.

- If any of the readings are above 128, do not use digital shift.
- If all of the readings are below 128, you can safely use the shift by 1 setting.
- If all of the readings are below 64, you can safely use the shift by 1 or 2 settings.
- If all of the readings are below 32, you can safely use the shift by 1, 2, or 3 settings.
- If all of the readings are below 16, you can safely use the shift by 1, 2, 3, or 4 settings.

## 7.5.4 Enabling and Setting Digital Shift

You can enable or disable the digital shift feature by setting the value of the Digital Shift parameter. When the parameter is set to zero, digital shift will be disabled. When the parameter is set to 1, 2, 3, or 4, digital shift will be set to shift by 1, shift by 2, shift by 3, or shift by 4 respectively.

You can set the Digital Shift parameter values from within your application software by using the Basler pylon API. The following code snippet illustrates using the API to set the parameter values:

```
// Disable digital shift
camera.DigitalShift.SetValue( 0 );

// Enable digital shift by 2
camera.DigitalShift.SetValue( 2 );
```

You can also use the Basler pylon Viewer application to easily set the parameters.

For more information about the pylon API and the pylon Viewer, see Section 3.1 on [page 62](#).

# 7.6 Image Region of Interest (ROI)

The image region of interest (ROI) feature lets you specify a portion of the sensor array and after each image is acquired, only the pixel information from the specified portion of the array is transmitted out of the camera.

The region of interest is referenced to the top left corner of the sensor array. The top left corner is designated as column 0 and row 0 as shown in Figure 85.

The location and size of the region of interest is defined by declaring an offset X (coordinate), a width, an offset Y (coordinate), and a height. For example, suppose that you specify the offset X as 10, the width as 16, the offset Y as 6, and the height as 10. The region of the array that is bounded by these settings is shown in Figure 85.

The camera will only transmit pixel data from within the region defined by your settings. Information from the pixels outside of the region of interest is discarded.

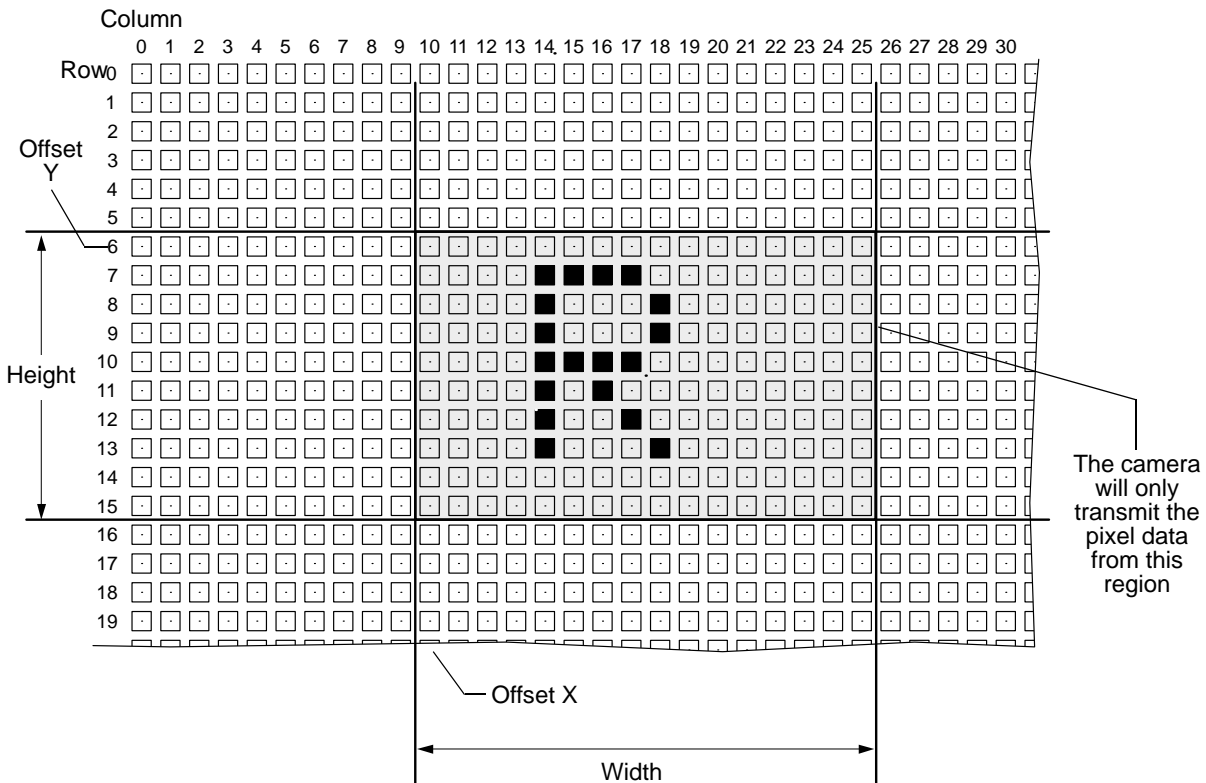

Fig. 85: Region of Interest

One of the main advantages of the image ROI feature is that decreasing the height of the ROI can increase the camera’s maximum allowed acquisition frame rate.

For more information about how changing the ROI height affects the maximum allowed frame rate, see Section 6.10 on [page 184](#).



If you want to set Offset X, make sure the Center X feature for automatic ROI centering is disabled.

If you want to set Offset Y, make sure the Center Y feature for automatic ROI centering is disabled.

For more information about automatic ROI centering and the effects on CenterX and CenterY settings, see Section 7.6.1 on [page 219](#).

## Guidelines for Setting the Image ROI

By default, the image ROI is set to use the full resolution of the camera's sensor. You can change the size and the position of the image ROI by changing the value of the camera's OffsetX, OffsetY, Width, and Height parameters.

- The value of the OffsetX parameter determines the starting column for the region of interest.
- The value of the OffsetY parameter determines the starting row for the region of interest.
- The value of the Width parameter determines the width of the region of interest.
- The value of the Height parameter determines the height of the region of interest.
- The value of the WidthMax parameter determines the maximum allowed width of the region of interest for the current OffsetX setting.
- The value of the HeightMax parameter determines maximum allowed height of the region of interest for the current OffsetY setting.

When you are setting the camera's region of interest, you must follow these guidelines:

On all camera models:

- The sum of the OffsetX setting plus the Width setting must not exceed the width of the camera's sensor. For example, on the acA1920-25um, the sum of the OffsetX setting plus the Width setting must not exceed 1920.
- The sum of the OffsetY setting plus the Height setting must not exceed the height of the camera's sensor. For example, on the acA1920-25um, the sum of the OffsetY setting plus the Height setting must not exceed 1080.

## Settings with Binning Disabled

The minimum settings and minimum increments for OffsetX, OffsetY, Width, and Height are given below, where a distinction is made between mono and color cameras. It is assumed that binning is disabled.

| Camera Model     | ROI Position and Size (Mono Cameras) |                   |          |                   |         |                   |         |                   |
|------------------|--------------------------------------|-------------------|----------|-------------------|---------|-------------------|---------|-------------------|
|                  | Offset X                             |                   | Offset Y |                   | Width   |                   | Height  |                   |
|                  | Minimum                              | Minimum Increment | Minimum  | Minimum Increment | Minimum | Minimum Increment | Minimum | Minimum Increment |
| acA640-90um      | 0                                    | 1                 | 0        | 1                 | 1       | 1                 | 1       | 1                 |
| acA640-120um     | 0                                    | 1                 | 0        | 1                 | 1       | 1                 | 1       | 1                 |
| acA640-750um     | 0                                    | 16                | 0        | 1                 | 16      | 16                | 1       | 1                 |
| acA800-510um     | 0                                    | 16                | 0        | 1                 | 16      | 16                | 1       | 1                 |
| acA1300-30um     | 0                                    | 1                 | 0        | 1                 | 1       | 1                 | 1       | 1                 |
| acA1300-200um    | 0                                    | 16                | 0        | 1                 | 16      | 16                | 1       | 1                 |
| acA1600-20um     | 0                                    | 1                 | 0        | 1                 | 1       | 1                 | 1       | 1                 |
| acA1920-25um     | 0                                    | 1                 | 0        | 1                 | 64      | 1                 | 64      | 1                 |
| acA1920-40um     | 0                                    | 4                 | 0        | 2                 | 4       | 4                 | 1       | 1                 |
| acA1920-150um    | 0                                    | 32                | 0        | 1                 | 32      | 32                | 1       | 1                 |
| acA1920-155um    | 0                                    | 4                 | 0        | 2                 | 4       | 4                 | 1       | 1                 |
| acA2000-165um    | 0                                    | 1                 | 0        | 1                 | 8       | 8                 | 1       | 1                 |
| acA2000-165umNIR | 0                                    | 1                 | 0        | 1                 | 8       | 8                 | 1       | 1                 |
| acA2040-55um     | 0                                    | 4                 | 0        | 2                 | 4       | 4                 | 1       | 1                 |
| acA2040-90um     | 0                                    | 1                 | 0        | 1                 | 8       | 8                 | 1       | 1                 |
| acA2040-90umNIR  | 0                                    | 1                 | 0        | 1                 | 8       | 8                 | 1       | 1                 |
| acA2040-120um    | 0                                    | 4                 | 0        | 2                 | 4       | 4                 | 1       | 1                 |
| acA2440-35um     | 0                                    | 4                 | 0        | 2                 | 4       | 4                 | 1       | 1                 |
| acA2440-75um     | 0                                    | 4                 | 0        | 2                 | 4       | 4                 | 1       | 1                 |
| acA2500-14um     | 0                                    | 1                 | 0        | 1                 | 64      | 1                 | 64      | 1                 |
| acA2500-60um     | 0                                    | 32                | 0        | 1                 | 32      | 32                | 1       | 1                 |
| acA3800-14um     | 0                                    | 1                 | 0        | 1                 | 64      | 1                 | 64      | 1                 |

Minimum Settings and Increments for Image ROI Position and Size in Mono Cameras (without Binning)



| Camera Model  | ROI Position and Size (Color Cameras) |                   |          |                   |         |                   |         |                   |
|---------------|---------------------------------------|-------------------|----------|-------------------|---------|-------------------|---------|-------------------|
|               | Offset X                              |                   | Offset Y |                   | Width   |                   | Height  |                   |
|               | Minimum                               | Minimum Increment | Minimum  | Minimum Increment | Minimum | Minimum Increment | Minimum | Minimum Increment |
| acA640-90uc   | 0                                     | 2                 | 0        | 2                 | 2       | 2                 | 2       | 2                 |
| acA640-120uc  | 0                                     | 2                 | 0        | 2                 | 2       | 2                 | 2       | 2                 |
| acA640-750uc  | 0                                     | 16                | 0        | 2                 | 16      | 16                | 2       | 2                 |
| acA800-510uc  | 0                                     | 16                | 0        | 2                 | 16      | 16                | 2       | 2                 |
| acA1300-30uc  | 0                                     | 2                 | 0        | 2                 | 2       | 2                 | 2       | 2                 |
| acA1300-200uc | 0                                     | 16                | 0        | 2                 | 16      | 16                | 2       | 2                 |
| acA1600-20uc  | 0                                     | 2                 | 0        | 2                 | 2       | 2                 | 2       | 2                 |
| acA1920-25uc  | 0                                     | 2                 | 0        | 2                 | 64      | 2                 | 64      | 2                 |
| acA1920-40uc  | 0                                     | 4                 | 0        | 2                 | 4       | 4                 | 2       | 2                 |
| acA1920-150uc | 0                                     | 32                | 0        | 2                 | 32      | 32                | 2       | 2                 |
| acA1920-155uc | 0                                     | 4                 | 0        | 2                 | 4       | 4                 | 2       | 2                 |
| acA2000-165uc | 0                                     | 2                 | 0        | 2                 | 8       | 8                 | 2       | 2                 |
| acA2040-55uc  | 0                                     | 4                 | 0        | 2                 | 4       | 4                 | 2       | 2                 |
| acA2040-90uc  | 0                                     | 2                 | 0        | 2                 | 8       | 8                 | 2       | 2                 |
| acA2040-120uc | 0                                     | 4                 | 0        | 2                 | 4       | 4                 | 2       | 2                 |
| acA2440-35uc  | 0                                     | 4                 | 0        | 2                 | 4       | 4                 | 2       | 2                 |
| acA2440-75uc  | 0                                     | 4                 | 0        | 2                 | 4       | 4                 | 2       | 2                 |
| acA2500-14uc  | 0                                     | 2                 | 0        | 2                 | 64      | 2                 | 64      | 2                 |
| acA2500-60uc  | 0                                     | 32                | 0        | 2                 | 32      | 32                | 2       | 2                 |
| acA3800-14uc  | 0                                     | 2                 | 0        | 2                 | 64      | 2                 | 64      | 2                 |
| acA4600-10uc  | 0                                     | 2                 | 0        | 2                 | 64      | 2                 | 64      | 2                 |

Table 46: Minimum Settings and Increments for Image ROI Position and Size in Color Cameras (without Binning)

## Settings With Binning Enabled



Normally, the OffsetX, OffsetY, Width, and Height parameter settings refer to the physical columns and rows of pixels in the sensor. But if binning is enabled, these parameters are set in terms of "virtual" columns and rows. For more information, see Section 7.8.1 on [page 250](#).

| Camera Model     | Minimum Physical ROI Height | Minimum Virtual ROI Height    |                               |                               |
|------------------|-----------------------------|-------------------------------|-------------------------------|-------------------------------|
|                  | No Vertical Binning         | Vertical Binning by 2 Enabled | Vertical Binning by 3 Enabled | Vertical Binning by 4 Enabled |
| acA640-90um      | 1                           | 1                             | 1                             | 1                             |
| acA640-120um     | 1                           | 1                             | 1                             | 1                             |
| acA640-750um     | 1                           | N/A                           | N/A                           | N/A                           |
| acA800-510um     | 1                           | N/A                           | N/A                           | N/A                           |
| acA1300-30um     | 1                           | 1                             | 1                             | 1                             |
| acA1300-200um    | 1                           | N/A                           | N/A                           | N/A                           |
| acA1600-20um     | 1                           | 1                             | 1                             | 1                             |
| acA1920-25um     | 64                          | 32                            | 22                            | 16                            |
| acA1920-25uc     | 64                          | 32                            | 22                            | 16                            |
| acA1920-40um     | 1                           | 1                             | 1                             | 1                             |
| acA1920-150um    | 1                           | N/A                           | N/A                           | N/A                           |
| acA1920-155um    | 1                           | 1                             | 1                             | 1                             |
| acA2000-165um    | 1                           | 1                             | 1                             | 1                             |
| acA2000-165umNIR | 1                           | 1                             | 1                             | 1                             |
| acA2040-55um     | 1                           | 1                             | 1                             | 1                             |
| acA2040-90um     | 1                           | 1                             | 1                             | 1                             |
| acA2040-90umNIR  | 1                           | 1                             | 1                             | 1                             |
| acA2040-120um    | 1                           | 1                             | 1                             | 1                             |
| acA2440-35um     | 1                           | 1                             | 1                             | 1                             |
| acA2440-75um     | 1                           | 1                             | 1                             | 1                             |
| acA2500-14um     | 64                          | 32                            | 22                            | 16                            |
| acA2500-14uc     | 64                          | 32                            | 22                            | 16                            |
| acA2500-60um     | 1                           | N/A                           | N/A                           | N/A                           |
| acA3800-14um     | 64                          | 32                            | N/A                           | 16                            |

Table 47: Minimum ROI Height Settings when Vertical Binning is Disabled and Enabled (Mono Cameras, acA1920-25uc, and acA2500-14uc)

| Camera Model     | Minimum Physical ROI Width | Minimum Virtual ROI Width       |                                 |                                 |
|------------------|----------------------------|---------------------------------|---------------------------------|---------------------------------|
|                  | No Horizontal Binning      | Horizontal Binning by 2 Enabled | Horizontal Binning by 3 Enabled | Horizontal Binning by 4 Enabled |
| acA640-90um      | 1                          | 1                               | 1                               | 1                               |
| acA640-120um     | 1                          | 1                               | 1                               | 1                               |
| acA640-750um     | 256                        | N/A                             | N/A                             | N/A                             |
| acA800-510um     | 256                        | N/A                             | N/A                             | N/A                             |
| acA1300-30um     | 1                          | 1                               | 1                               | 1                               |
| acA1300-200um    | 256                        | N/A                             | N/A                             | N/A                             |
| acA1600-20um     | 1                          | 1                               | 1                               | 1                               |
| acA1920-25um     | 64                         | 32                              | 22                              | 16                              |
| acA1920-25uc     | 64                         | 32                              | 22                              | 16                              |
| acA1920-40um     | 4                          | 4                               | 4                               | 4                               |
| acA1920-150um    | 256                        | N/A                             | N/A                             | N/A                             |
| acA1920-155um    | 4                          | 4                               | 4                               | 4                               |
| acA2000-165um    | 8                          | 8                               | 8                               | 8                               |
| acA2000-165umNIR | 8                          | 8                               | 8                               | 8                               |
| acA2040-55um     | 4                          | 4                               | 4                               | 4                               |
| acA2040-90um     | 8                          | 8                               | 8                               | 8                               |
| acA2040-90umNIR  | 8                          | 8                               | 8                               | 8                               |
| acA2040-120um    | 4                          | 4                               | 4                               | 4                               |
| acA2440-35um     | 4                          | 4                               | 4                               | 4                               |
| acA2440-75um     | 4                          | 4                               | 4                               | 4                               |
| acA2500-14um     | 64                         | 32                              | 22                              | 16                              |
| acA2500-14uc     | 64                         | 32                              | 22                              | 16                              |
| acA2500-60um     | 256                        | N/A                             | N/A                             | N/A                             |
| acA3800-14um     | 64                         | 32                              | N/A                             | 16                              |

Table 48: Minimum ROI Width Settings when Horizontal Binning is Disabled and Enabled (Monochrome Cameras, acA1920-25uc, and acA2500-14uc)

You can set the OffsetX, OffsetY, Width, and Height parameter values from within your application software by using the Basler pylon API. The following code snippets illustrate using the API to get the maximum allowed settings for the Width and Height parameters. They also illustrate setting the Offset X, OffsetY, Width, and Height parameter values:

```
int64_t i = camera.WidthMax.GetValue();

camera.Width.SetValue(1294);
camera.OffsetX.SetValue(0);

int64_t i = camera.HeightMax.GetValue();

camera.Height.SetValue(964);
camera.OffsetY.SetValue(0);
```

You can also use the Basler pylon Viewer application to easily set the parameters.

For more information about the pylon API and the pylon Viewer, see Section 3.1 on [page 62](#).

## 7.6.1 Center X and Center Y

The ROI feature also includes Center X and Center Y capabilities for horizontal and vertical centering. When CenterX is enabled, the camera will automatically center the ROI along the sensor's X axis. When CenterY is enabled, the camera automatically centers the ROI along the sensor's Y axis.



When CenterX is enabled, the OffsetX setting is adjusted accordingly and becomes read only.

**Note:** When CenterX is disabled, the original OffsetX setting that applied when CenterX was enabled, is not automatically restored. If you want to return to the original OffsetX setting, you have to do so "manually".

The enabling of CenterY has an analogous effect on OffsetY settings.

### Enabling ROI Centering

You can enable ROI centering from within your application software by using the Basler pylon API. The following code snippet illustrates using the API to enable automatic ROI centering:

```
camera.CenterX.SetValue(true);
camera.CenterY.SetValue(true);
```

## 7.6.2 Changing ROI Parameters "On-the-Fly"

Making ROI parameter changes "on-the-fly" means making the parameter changes while the camera is capturing images continuously. On-the-fly changes are only allowed for the parameters that determine the position of the ROI, i.e., the OffsetX and OffsetY parameters. Changes to the ROI size are not allowed on-the-fly.

## 7.7 Sequencer



When the auto functions feature is enabled, the sequencer feature will not be available. For more information about the auto functions feature, see Section 7.15 on [page 299](#).

### 7.7.1 Introduction

The sequencer feature allows you to apply different sets of configuration parameter settings, called sequencer sets, to a sequence of image acquisitions. As the images are acquired, one sequencer set after the other is applied. This makes it possible to quickly respond to changing imaging requirements while acquiring images. For example, imaging requirements will change when the illumination changes.

After camera startup or reset, the sequencer sets will be available with default parameter values according to the settings of the default user set. Each sequencer set is identified by an index number that can range from zero through 31. Accordingly, up to 32 different sequencer sets are available.

To have sequencer sets available for your specific requirements, you will, however, usually want to configure the sequencer sets. This will include changing parameter values to make them appropriate for your requirements (see Section 7.7.3 on [page 229](#)). To change the parameter values of a sequencer set, you must first load the sequencer set into the active set. For more information about sequencer configuration, see Section 7.7.3 on [page 229](#). For more information about the active set, see Section 7.21 on [page 331](#).

### Sequencer Modes

The sequencer feature is enabled when you set it to either of two different modes:

- In the **sequencer configuration mode**, the sequencer sets can be configured but not be used for image acquisition.  
The sequencer configuration mode must be set to On and the sequencer mode must be set to Off.
- In the **sequencer mode** (also called "sequencer mechanism"), the sequencer sets can be used for image acquisition but not be configured.  
The sequencer mode must be set to On.

The sequencer feature is disabled when the sequencer configuration mode and the sequencer mode are both set to Off.



When the sequencer feature is in sequencer mode, the parameter values of the current sequencer set cannot be changed using the pylon API or the pylon Viewer. Only those sequencer set parameter values are displayed that were active before the sequencer was enabled. You can not "see" the parameter values delivered by the current set.

We recommend that you do not attempt to read or change any of the sequence parameters when the sequencer feature is enabled.



Because your parameter values for the sequencer sets only reside in volatile memory, the parameter values will be lost and reset to the default values if the camera is reset or switched off. You will then have to populate the sequencer sets with your parameter values again.

Note also that sequencer sets can not be saved in user sets.



When the camera enters the over temperature mode. while the sequencer is in sequencer mode, the sequencer stops operating. When the camera exits the over temperature mode the sequencer does **not** resume operation. However, the parameter values for the sequencer sets are preserved in volatile memory.

## 7.7.2 The Sequencer and the Active Set

During operation, the camera is controlled by a set of configuration parameters settings that reside in the camera's volatile memory. This set of parameter settings is known as the "active set" .

When you use the pylon API or the pylon Viewer to make a change to a camera parameter such as the Gain, you are making a change to the active set. And because the active set controls camera operation, you will see a change in camera operation when you change a parameter value in the active set. For more information about the active set, see Section 7.21 on [page 331](#).

The parameters in the active set can be divided into two types:

- **Non-sequencer** parameters: The parameter values in the active set cannot be changed using the sequencer feature. This also means that the non-sequencer parameter values cannot be configured for user sets.
- **Sequencer** parameters: The parameter values in the active set can be changed almost instantaneously by loading a sequencer set.

The "current set" is the sequencer set whose parameter values were loaded into the active set with the latest sequencer set advance. The parameter values remain in the active set until they are replaced by the parameter values of the next sequencer set.

The sequencer parameters can be divided into two types (see [Figure 86](#)):

- **Camera** parameters for camera control (e.g. exposure time, gain, ROI position and size, see also [Section 7.7.2.1](#)).
- **Sequencer set related** parameters for sequencer control. The parameters define the details of advancing from one sequencer set to the next. This includes the possibility of choosing between different "paths" for advance, thus allowing to choose between different sequencer sets (see [Figure 86](#) and [Section 7.7.2.2](#)).

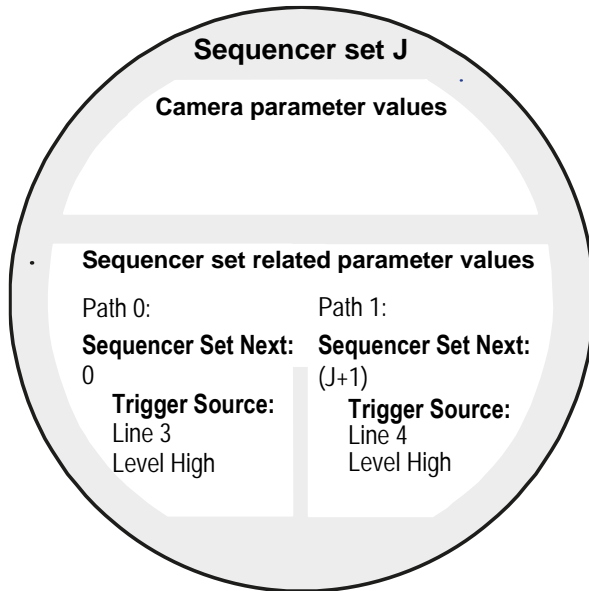

Fig. 86: Sequencer Parameters of Sequencer Set with Index Number J (Most Parameter Values as Examples)

### 7.7.2.1 Camera Parameters

Each sequencer set controls the parameter values for the following camera parameters.

|                                 |  |
|---------------------------------|--|
| PixelFormat <sup>1)</sup>       | CenterX                                    |
| ExposureTime                    | CenterY                                    |
| AcquisitionFrameRate            | ReverseX                                   |
| AcquisitionFrameRateEnable      | ReverseY <sup>2)</sup>                     |
| TimerDelay (for Timer 1)        | ScalingHorizontal                          |
| TimerDuration (for Timer 1)     | BinningHorizontal                          |
| CounterEventSource              | BinningVertical                            |
| CounterResetSource              | LUTEnable <sup>3)</sup>                    |
| CounterDuration (for Counter 2) | BalanceRatio                               |
| Gain                            | ColorAdjustmentHue <sup>4) 5)</sup>        |
| BlackLevel                      | ColorAdjustmentSaturation <sup>4) 5)</sup> |
| DigitalShift                    | ColorTransformationValue <sup>4)</sup>     |
| OffsetX                         | ChunkModeActive                            |
| OffsetY                         | ChunkEnable                                |



Width  
Height

TestImageSelector

1) Parameter is not available for use with the sequencer for the following cameras: acA1920-40, acA1920-155, acA2000-165, acA2040-55, acA2040-90, acA2040-120, acA2440-35, and acA2440-75.

2) Parameter is only available for the following cameras: acA640-750, acA800-510, acA1300-200, acA1920-40, acA1920-150, acA1920-155, acA2000-165, acA2040-55, acA2040-90, acA2040-120, acA2440-35, and acA2440-75.

3) Parameter is only available for use with the sequencer if the Gamma parameter is set to 1 and if no light source preset is selected.

4) Parameter is only available for color cameras.

5) Parameter is not available for acA2000-165uc and acA2040-90uc cameras.

## 7.7.2.2 Sequencer Set Related Parameters and Sequencer Set Advance

### Sequencer Set Related Parameters

To each sequencer set the parameter values for the following sequencer set related parameters apply.

|                            |                                 |
|----------------------------|---------------------------------|
| SequencerSetStart          | CounterEventSource              |
| SequencerSetSelector       | CounterResetSource              |
| SequencerSetPath           | CounterDuration (for Counter 2) |
| SequencerSetNext           |                                 |
| SequencerTriggerSource     |                                 |
| SequencerTriggerActivation |                                 |

- The Sequencer Set Start parameter defines the first sequencer set that will be loaded into the active set after the following two actions have occurred:
  - the sequencer mode was set to On and
  - the first frame start trigger was issued.

For all Basler USB 3.0 ace cameras, the Sequencer Set Start parameter value must always be set to 0. This selects sequencer set 0 as the first sequencer set to be loaded and used for an image acquisition.

- The Sequencer Set Selector parameter selects a sequencer set by its index number. Selecting a sequencer set is necessary when configuring a sequencer set (see Section 7.7.3 on

[page 229](#)) or when loading a sequencer set into the active set (see Section 7.7.3.3 on [page 232](#)).

- The Sequencer Set Path parameter selects a path by its index number. Two different paths are available, path 0 and path 1. Each path allows to configure a distinct scheme for advancing from one sequencer set to the next.

|   |   |
|---|---|
|  | <p>We strongly encourage setting different sequencer trigger sources for path 0 and path 1.</p> |
|---|---|

Path 0 and path 1 serve different purposes and should be configured accordingly:

- Path 1 provides the scheme that allows to cycle through the available sequencer sets. This is the mechanism for the standard use of the sequencer feature,
- Path 0 allows to return to sequencer set 0 at any time and therefore provides a way for resetting the cycling through the sequencer sets that is carried out according to path 1.

For each path, the following parameters must be set (see also [Figure 86](#)):

- SequencerSetNext: Selects the sequencer set to be loaded next into the active set after the present one when a trigger occurs for the related trigger source (see next entry). The next sequencer set will replace the present one in the active set.
- SequencerTriggerSource: Selects the trigger source for the trigger that will load the next sequencer set into the active set. The following sequencer trigger sources are available (for more information, see the section below). Note however, that different sets of trigger sources are available for path 0 and path1 (for the differences, see Table 49 on [page 226](#)):
  - Line 1: Line IN
  - Line 3: GPIO
  - Line 4: GPIO
  - Software Signal 1: Software command
  - Software Signal 2: Software command
  - Software Signal 3: Software command (not available on acA1920-155 cameras).
  - Counter 2 End
  - Frame Start

Note that Line 3 and Line 4 can be selected regardless of whether they are configured for input or output.

- For each selected sequencer trigger source, the following parameter must be set (see also [Figure 86](#)):
  - SequencerTriggerActivation: Selects the line status required to trigger loading of the next sequencer set into the active set. The only available parameter value is Level High.

## Synchronous and Asynchronous Sequencer Set Advance

The mechanisms for sequencer set advance vary between sequencer trigger sources:

- The triggers from some sequencer trigger sources only select the next sequencer set and the loading into the active set occurs with the subsequent frame start trigger.
- The triggers from the other sequencer trigger sources select **and** load the next sequencer set.

The mechanisms are presented in greater detail in the following table and sections:

| Sequencer Trigger Source | Selects Next Sequencer Set |            | Loads Next Sequencer Set Into the Active Set | Frame Start Trigger Loads Next Sequencer Set Into the Active Set | Type of Sequencer Trigger Source |        |
|--------------------------|----------------------------|------------|--|--|----------------------------------|--------|
|                          | for Path 0                 | for Path 1 |  |  | Sync.                            | Async. |
| Line 1                   | •                          | •          |  | •  | •                                |        |
| Line 2                   | •                          | •          |  | •  | •                                |        |
| Line 3                   | •                          | •          |  | •  | •                                |        |
| Software Signal 1        | •                          | •          | •  |  |                                  | •      |
| Software Signal 2        | •                          | •          | •  |  |                                  | •      |
| Software Signal 3*       | •                          | •          | •  |  |                                  | •      |
| Counter 2 End            |                            | •          |  | •  | •                                |        |
| Frame Start              |                            | •          |  | •  | •                                |        |

Table 49: Sequencer Trigger Sources by Path and Related Mechanism for Sequencer Set Advance.

\* Not available on acA1920-155, acA2040-55, acA2040-120, acA2440-35, and acA2440-75 cameras.

## Sequencer Trigger Sources and Sequencer Set Advance

Two different types of trigger sources are available for advancing from one sequencer set to the next:

- When a trigger source for a so-called **synchronous** trigger is selected the trigger will select the next sequencer set but the actual advance to the next sequencer set will happen with the next frame start trigger. Each sequencer set advance is therefore closely tied to a frame start trigger and will accordingly be synchronous to the frame start trigger.

The sequencer trigger sources for synchronous triggers are Line 1, Line 3, Line 4, frame start, and Counter 2 End (see also Section 7.7.2.2 on [page 224](#)).

- When a trigger source for a so-called **asynchronous** trigger is selected the advance to the next sequencer set will immediately be initialized by the trigger, but will happen with some unspecified delay. The sequencer set advance is therefore not tied to frame start triggers and, accordingly, will be asynchronous to the frame start trigger.

The sequencer trigger sources for asynchronous triggers are Software Signal 1, Software Signal 2, Software Signal 3 (see also Section 7.7.2.2 on [page 224](#)).

## Trigger Sources for Synchronous Sequencer Set Advance

When triggers are applied from synchronous trigger sources, the advance from one sequencer set to the next will be closely tied to the frame start triggers:

- When **frame start** trigger is the trigger source, the next sequencer set will be immediately loaded into the active set as soon as a frame start trigger occurs and applied to the image acquisition. Only available for path 1.
- When **Line 1** (dedicated input line) or **Line 3** or **Line 4** (GPIO lines set for input) is the trigger source and when the related trigger signal occurs the signal will go high and thereby select the next sequencer set for sequencer set advance. When a subsequent frame start trigger occurs, the state of the trigger signal for sequencer set advance is evaluated. As the level will be high, the related sequencer set is loaded into the active set and is applied to the image acquisition.
- The **Counter 2 End** trigger source is useful when you want that a user set is applied to a number of consecutive image acquisitions.

Counter 2 End refers to Counter 2 that counts consecutive frame start triggers. When Counter 2 End is the trigger source, advance to the next sequencer set will only be possible after Counter 2 has reached the set Counter Duration value. The counting starts from 1 to the set Counter Duration value and will then resume again from 1. The Counter Duration value can be set to an integer value between 1 and 256. The trigger source is generated within the camera. Only available for path 1.

You can achieve operation with tightly constrained timing between sequencer set advance and frame start triggers if you use an external signal for the frame start triggers and use the "fast" GPIO lines, Line 3 and Line 4, as trigger sources for paths 0 and 1. The timing will be even tighter constrained if you use one GPIO line as trigger source for path 0 and the other GPIO line as the trigger source for both, frame start trigger and path 1 triggering. In this case, you would ideally use the falling edges of the GPIO input signals as they are the "fast" edges.

See Section 5.10 on [page 86](#) for information about making optimum use of the temporal performance of the GPIO lines. See Section 5.9 on [page 80](#) about the limitations of use of GPIO lines in an environment with significant electromagnetic interference.

## Trigger Sources for Asynchronous Sequencer Set Advance

When triggers are applied from asynchronous trigger sources, the triggers will be the software commands **Software Signal 1**, **Software Signal 2**, and **Software Signal 3**. The software commands will not only select sequencer sets but also load them into the active set.



Due to signal processing and transmission, there is an unspecified delay between issuing the command and the sequencer set loading. Accordingly, the number of image acquisitions that may occur between sending the software command and it becoming effective can't be predicted.

We therefore strongly discourage using an asynchronous sequencer set advance trigger source for real-time applications.



If you use a software signal to trigger sequencer set advance for path 1 you can skip sequencer sets with regard to image acquisition by triggering sequencer set advance at a higher rate than the current frame acquisition rate.

Skipping is possible because sequencer set advance triggered by software signals is asynchronous, i.e. is not tied to frame start triggers (see also [Table 52](#) and use case 3).

## 7.7.3 Sequencer Configuration

### 7.7.3.1 General Information

When configuring the sequencer, the following rules apply:

#### Required parameter values

- Sequencer Set Start values must always be set to 0. This ensures that sequencer set 0 is always the first set available for image acquisition after sequencer start or reset.
- The Sequencer Trigger Activation parameter must always be set to Level High (positive logic).
- The other path-related parameter values must differ between paths 0 and 1, in particular the Sequencer Trigger Source parameter value. We recommend to first set the path-specific sequencer trigger sources for sequencer set 0 and then the path-specific sequencer trigger sources for the other sequencer sets.
- Each sequencer set must include exactly one subset of parameter values relating to path 0 and exactly one subset relating to path 1.

This ensures that each sequencer set "knows" what role to play within each path, i.e. within each sequencer set advance scheme.

#### Additional rules for configuring sequencer set 0

- For Sequencer Set 0, the Sequencer Set Next value must be set to path 0. In addition, the Sequencer Set Next value must be set to Sequencer Set 1 for path 1 in order to be able to "leave" user set 0 during image acquisition and to realize the application described in Section 7.7.4 on [page 233](#).

#### Additional rules for configuring sequencer sets for path 1

- The sequencer sets must be configured in order of ascending and consecutive index numbers.
- For all sequencer sets except for the one with the highest index number: The Sequencer Set Next parameter value set for sequencer set J must always be set to sequencer set index number (J+1). For example, for path 1 used with sequencer set 2 the Sequencer Set Next parameter value must be set to 3.
- For the sequencer set with the highest index number: The Sequencer Set Next parameter value for path 1 used with the sequencer set with the highest index number must be set to 0. For example, if four sequencer sets are to be used, the Sequencer Set Next parameter value for path 1 used with the fourth sequencer set (index number = 3) must be set to 0.

This ensures that each sequencer set cycle (according to path 1) resumes with sequencer set 0.

### 7.7.3.2 Carrying Out Configuration

|   |  |
|---|--|
|  | <p>Before configuring sequencer sets: Make sure the sequencer mode is set to Off and the sequencer configuration mode is set to On.</p> <p>Otherwise the parameter values of the current sequencer set cannot be read or changed using the pylon API or the pylon Viewer. Only those sequencer set parameter values will be displayed that were active before the sequencer mode was set to On.</p> <p>You will not be able to "see" the new parameter values set for the current sequencer set.</p> <p>We recommend that you do not attempt to read or change any of the sequencer parameters when the sequencer mode is set to On.</p> |
|---|--|

|   |   |
|---|---|
|  | <p>It may occur that you will not configure all parameter values used with a sequencer set (see Section 7.7.2 on <a href="#">page 222</a>). In these cases, the previous parameter values will persist in the active set.</p> |
|---|---|

Carry out the following routine for each sequencer set you want to configure.

#### To configure and store a sequencer set:

1. Make sure the value of the Sequencer Mode is set to Off.
2. Make sure the value of the Sequencer Configuration Mode is set to On.
3. To configure the desired sequencer set, select its index number.
4. Set the camera parameter values as desired.
5. Set the sequencer set-related parameter values for path 0.
6. Set the sequencer set-related parameter values for path 1.

Note: The following step will replace any previous parameter settings for the selected sequencer set.

7. Store the sequencer set with its changed parameter values.

The sequencer set is available for use by the sequencer feature with new parameter values.

You can configure the sequencer and sequencer sets from within your application software by using the Basler pylon API. The following code snippet illustrates configuring the parameters for sequencer start and for sequencer set 0, and storing sequencer set 0 using the API to set the parameter values.

The example assumes that you have already set the current camera parameter values as desired for sequencer set 0. The example assumes that you are setting the parameter values for sequencer set 0 as given in Figure 86 on [page 223](#) and Table 50 on [page 236](#).

```
// Disable the sequencer feature
camera.SequencerMode.SetValue(SequencerMode_Off);
// Enable the sequencer configuration mode
camera.SequencerConfigurationMode.SetValue(SequencerConfigurationMode_On);
// Select the first sequencer set (always sequencer set 0)
camera.SequencerSetStart.SetValue(0);

// Select a sequencer set by its index number
camera.SequencerSetSelector.SetValue(0);
// Select path 0 for the selected sequencer set
camera.SequencerPathSelector.SetValue(0);

// Select the sequencer set that will be applied after the current sequencer set
camera.SequencerSetNext.SetValue(0);
// Select the trigger source for sequencer set advance
camera.SequencerTriggerSource.SetValue(SequencerTriggerSource_Line_3);
// Select the logic for the sequencer set advance trigger source for path 0(always
LevelHigh)
camera.SequencerTriggerActivation.SetValue(SequencerTriggerActivation_Level-
High);

// Select path 1 for the selected sequencer set
camera.SequencerPathSelector.SetValue(1);
// Select the sequencer set that will be applied after the current sequencer set
camera.SequencerSetNext.SetValue(1);
// Select the trigger source for sequencer set advance
camera.SequencerTriggerSource.SetValue(SequencerTriggerSource_Line_4);
// Select the logic for the sequencer set advance trigger source for path 1(always
LevelHigh)
camera.SequencerTriggerActivation.SetValue(SequencerTriggerActivation_Level-
High);

// Save the camera parameter values and the sequencer set-related parameter values
for the selected sequencer set
camera.SequencerSetSave.Execute( );
```

You can also use the Basler pylon Viewer application to easily set the parameters.

For more information about the pylon API and the pylon Viewer, see Section 3.1 on [page 62](#).



### 7.7.3.3 Using the Load Command

There is also the Sequencer Set Load command that can be useful when working with the sequencer sets for testing purposes. If you select a sequencer set by using its index number and then you execute the Sequencer Set Load command, the sequencer-controlled parameter values in the active set will be replaced by the values stored for the selected sequencer set.

This ability can be useful in two situations. First, if you simply want to see how the parameters currently stored for one of the sequencer sets will affect camera operation, you can load the parameters from that sequencer set into the active set and see what happens. Second, if you want to prepare a new sequencer set and you know that an existing set is already close to what you will need, you can load the existing sequencer set into the active set, make some small changes to the active set, and then save the active set as a new sequencer set.

Make sure the sequencer mode is set to Off before issuing the Sequence Set Load command.



Replacing the sequence-controlled parameter values in the active set via the Sequencer Set Load command is associated with a delay between sending the software command and it becoming effective. The delay will depend on the specific installation and the current load on the network. Accordingly, the number of image acquisitions that can occur between sending the command and it becoming effective can not be predicted. The Sequencer Set Load command is therefore not suitable for real-time applications, it can, however, be useful for testing purposes.

The following code snippet illustrates using the API to load the sequencer set parameter values from sequencer set 1 into the active set:

```
// Select sequencer set 1 by its index number
camera.SequencerSetSelector.SetValue(1);
// Load the sequencer parameter values from the sequencer set into the active set
camera.SequencerSetLoad.Execute( );
```

You can also use the Basler pylon Viewer application to easily set the parameters.

## 7.7.4 Sequencer Operation

In this section, you will find a duplicate description of sequencer operation in sequencer mode:

- a general overview employing a state diagram ([Figure 87](#)), and
- a more elaborate presentation of selected use cases ([Figure 88](#) through [Figure 90](#)).

As explained in [Section 7.7.1](#), there are a sequencer configuration mode for sequencer configuration and the sequencer mode that allows to apply different sequencer sets in quick succession to different frame acquisitions.

In the sequencer mode, one sequencer set after the other can be loaded into the active set ("sequencer set advance") as frames are acquired. The loading is controlled by using certain sequencer trigger sources that can be selected for two schemes of sequencer set advance, called paths. For more information about sequencer trigger sources, sequencer set advance, and paths, see [Section 7.7.2.2](#).

The actual sequence of sequencer sets that will be loaded into the active set as images are acquired depends on the number of configured sequencer sets, on the use of the sequencer trigger sources selected for path 0 and path 1, and on the use of the paths. For more information about sequencer trigger sources and paths, see [Section 7.7.2.2](#).

As mentioned in [Section 7.7.2.2](#), paths 0 and path 1 play different roles: The cycling through the available sequencer sets can be accomplished using the path 1 sequencer trigger source. Using the path 0 sequencer trigger source will load sequencer set 0 into the active set. This will reset the cycling and allow its restart.



To ensure reliable coordination between synchronous sequencer set advance and frame start triggering, allow sufficient time to elapse between the moment when the sequencer set advance trigger signal has reached the high status and the subsequent frame start trigger signal going high.

In particular, consider the propagation delays associated with the camera's input lines: To minimize propagation delays, we recommend choosing the GPIO input lines as the sources for both, the sequencer set advance trigger signal and the frame start trigger signal. In this context, we recommend not using the opto-isolated input line unless robustness against EMI is required.

You can achieve the tightest timing control if you set the frame start trigger signal as the source for the sequencer set advance trigger signal.

We also recommend using the "fast" edges of the input lines.

For more information about propagation delays of the input lines, see [Section 5.10](#) on [page 86](#).

Note: You may occasionally encounter a transitional "dummy" sequencer set with index number -1. Ignore this set. It occurs for technical reasons only and cannot be used for image acquisition.

## Sequencer States Occurring During Start and in "Sequencer Mode"

In the state diagram ([Figure 87](#)) a total of four sequencer sets is considered. The diagram illustrates sequencer start, sequencer operation in "sequencer mode", and sequencer stop. Operation in "sequencer configuration mode" (see [Section 7.7.3 on page 229](#)) is not illustrated.

- As illustrated in [Figure 88](#), the camera must not acquire images when the sequencer feature is enabled. Setting the sequencer mode to On will enable the sequencer feature. When a frame start trigger occurs the sequencer set configured as Sequencer Set Start will be loaded into the active set and will be used for the first image acquisition. Sequencer Set Start will always be sequencer set 0 (see [Section 7.7.2.2 on page 224](#)).
- By using the trigger for path 1, you can cycle through the available sequencer sets. By using the trigger for path 0 you can return at any time to sequencer set 0 and therewith reset the cycling.
- Setting the sequencer mode to Off will disable the sequencer feature for use with frame acquisitions.

The parameter values that were in the active set immediately before the sequencer feature was enabled will reappear in the active set and will overwrite the values of the latest sequencer set.

### Effect on Frame Rate

For all cameras except the acA1920-25 and acA2500-14 cameras, the loading of sequencer sets into the camera's active set has no effect on the camera's frame rate as long as all image acquisitions are carried out along the same path, i.e. along path 1. Switching between paths 0 and 1 can decrease the frame rate.

For the acA1920-25 and acA2500-14 cameras, the loading of sequencer sets into the camera's active set will decrease the camera's frame rate. The frame rate will, however, not decrease as long as no new sequencer set is loaded.

Using the sequencer feature will affect the frame rates of all cameras if dictated by parameter values that are controlled by sequencer sets (ExposureTime, AcquisitionFrameRate).

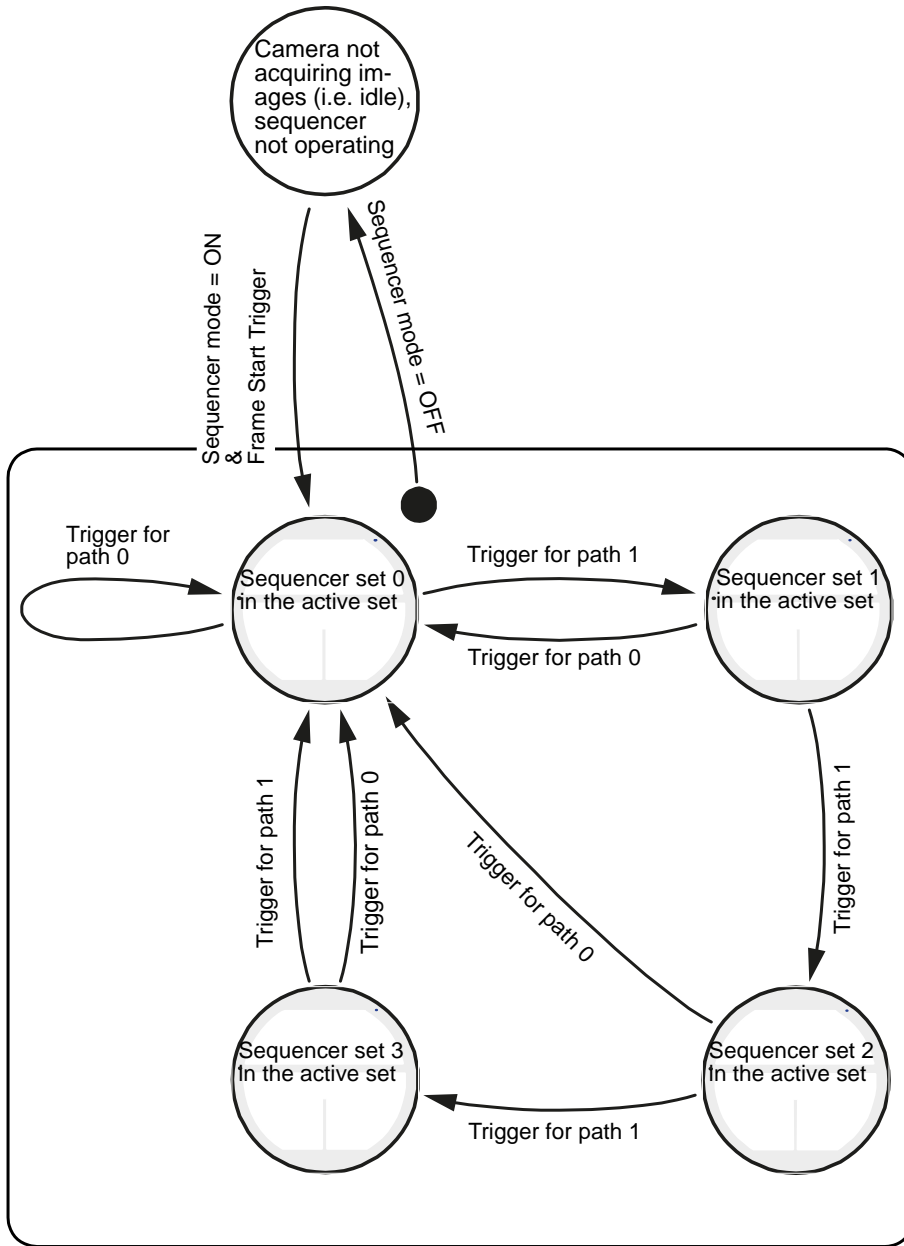



Fig. 87: State Diagram for the "Sequencer Mode" (Start and Operation; Four Sequencer Sets as an Example)

### 7.7.4.1 Sequencer Use Case Descriptions and Diagrams

The following use case descriptions and diagrams illustrate operation of the sequencer feature in sequencer mode. The use cases refer to some common situations and combinations of parameter settings.

These use cases do not represent every possible combination of the parameters settings associated with the sequencer. The use cases are simply intended to aid you in developing an initial understanding of the relation between parameter settings and sequencer operation.

In each use case diagram, the black box in the upper left corner indicates how the parameters are set.

|   |   |
|---|---|
|  | The use case diagrams are representational. They are not drawn to scale and are not designed to accurately describe precise camera timings. |
|---|---|

All trigger signals shown in the use case diagrams assume rising edge triggering. Note, however, that the timing of triggers involving a GPIO line is tighter constrained when set for falling edge triggering (see Section 5.10 on [page 86](#)).

The use cases assume that a total of four sequencer sets is available.

#### Use Case 1 - Cycling Through Sequencer Sets According to Path 1

Use case one is illustrated in Figure 88 on [page 240](#) and assumes that the following sequencer-related parameter values are set.

|               | Sequencer Set Related Settings       | Sequencer Set 0 | Sequencer Set 1 | Sequencer Set 2 | Sequencer Set 3 |
|---------------|--------------------------------------|-----------------|-----------------|-----------------|-----------------|
| <b>Path 0</b> | Next sequencer set after current one | 0**             | 0**             | 0**             | 0**             |
|               | Trigger source                       | Line 3 (GPIO)   | Line 3 (GPIO)*  | Line 3 (GPIO)*  | Line 3 (GPIO)*  |
|               | Trigger activation                   | Level High**    | Level High**    | Level High**    | Level High**    |
| <b>Path 1</b> | Next sequencer set after current one | 1**             | 2**             | 3**             | 0               |
|               | Trigger source                       | Line 4 (GPIO)   | Line 4 (GPIO)*  | Line 4 (GPIO)*  | Line 4 (GPIO)*  |
|               | Trigger activation                   | Level High**    | Level High**    | Level High**    | Level High**    |

Table 50: Settings for Sequencer Operation According to Use Case 1.

\* Only one trigger source for a path allowed.

\*\*Applies Always, Not Only in this Example

## Use Case One in Overview

Use case one demonstrates synchronous triggering cycling through all the available four sequencer sets, not disturbed by a reset. The possibility of repeatedly applying a sequencer set to a succession of frame acquisitions is also shown.

The GPIO lines are configured for input and allow to control sequencer set advance for path 0 and path 1 by external triggers. The frame start trigger is controlled by external signals via the opto-isolated input line Line 1. Accordingly, sequencer operation and frame acquisition are all controlled by external triggers. This allows tight synchronization between triggers for sequencer set advance and frame start triggers.

The trigger assigned to path 1 goes low between most frame start triggers and, if desired, goes high well ahead before the frame start triggers rise. This ensures that the trigger signals assigned to path 1 have reached the desired signal levels in time before they will be evaluated by the frame start trigger with respect to sequencer set advance.

Another aspect of sequencer set advance becomes apparent: The signal levels of the external triggers assigned to path 1 and path 0 will matter for sequencer set advance only at the moment when they are evaluated by the frame start trigger (not shown for path 0 in this use case). The moment occurs when the frame start trigger signal rises assuming the frame start trigger signal is set for rising edge triggering. The signal levels of the external triggers assigned to path 1 and path 0 that occur between frame start triggers have no effect on sequencer set advance.

## Use Case One in Detail

Assuming that the sequencer sets are configured according to Table 50 on [page 236](#) and the camera is not acquiring images, the sequencer feature operates as follows:

- When the Sequencer Mode parameter value is set to On the sequencer feature becomes enabled for the application of sequencer sets during image acquisitions. The transitional "dummy" sequencer set with index number -1 is loaded into the active set, overwriting the previous sequencer parameter values (Section 7.7.2 on [page 222](#)).
- A trigger signal assigned to path 1 is received, setting the signal level to high.
- When the frame start trigger signal was received the trigger signal assigned to path 1 is found to be high. As a result, the frame start trigger triggers the loading of the next sequencer set, that is sequencer set 0, into the active set. Sequencer set 0 overwrites the parameter values of sequencer set -1 in the active set.

A frame acquisition is carried out using the parameter values of sequencer set 0. The image data are processed and transmitted out of the camera.

The trigger signal assigned to path 1 goes low.

- The trigger signal assigned to path 1 goes high.
- When the next frame start trigger signal was received the trigger signal assigned to path 1 is found to be high. As a result, the frame start trigger triggers the loading of the next sequencer set, that is sequencer set 1, into the active set. The parameter values for sequencer set 1 overwrite the parameter values for sequencer set 0 in the active set.

A frame acquisition is carried out using the parameter values of sequencer set 1. The image data are processed and transmitted out of the camera.

The trigger signal assigned to path 1 goes low.

- The trigger signal assigned to path 1 goes high.
- When the next frame start trigger signal was received the trigger signal assigned to path 1 is found to be high. As a result, the frame start trigger triggers the loading of the next sequencer set, that is sequencer set 2, into the active set. The parameter values for sequencer set 2 overwrite the parameter values for sequencer set 1 in the active set.

A frame acquisition is carried out using the parameter values of sequencer set 2. The image data are processed and transmitted out of the camera.

- The trigger signal assigned to path 1 goes low.
- The trigger signal assigned to path 1 goes high.
- When the next frame start trigger signal was received the trigger signal assigned to path 1 is found to be high. As a result, the frame start trigger triggers the loading of the next sequencer set, that is sequencer set 3, into the active set. The parameter values for sequencer set 3 overwrite the parameter values for sequencer set 2 in the active set.

A frame acquisition is carried out using the parameter values of sequencer set 3. The image data are processed and transmitted out of the camera.

The trigger signal assigned to path 1 goes low.

- The trigger signal assigned to path 1 goes high.
- When the next frame start trigger signal was received the trigger signal assigned to path 1 is found to be high. As a result, the frame start trigger triggers the loading of the next sequencer set, that is sequencer set 0, into the active set. The parameter values for sequencer set 0 overwrite the parameter values for sequencer set 3 in the active set. A new cycle of sequencer sets starts.

A frame acquisition is carried out using the parameter values of sequencer set 0. The image data are processed and transmitted out of the camera.

The trigger signal assigned to path 1 goes low.

- The trigger signal assigned to path 1 goes high.
- When the next frame start trigger signal was received the trigger signal assigned to path 1 is found to be high. As a result, the frame start trigger triggers the loading of the next sequencer set, that is sequencer set 1, into the active set. The parameter values for sequencer set 1 overwrite the parameter values for sequencer set 0 in the active set.

A frame acquisition is carried out using the parameter values of sequencer set 1. The image data are processed and transmitted out of the camera.

The trigger signal assigned to path 1 stays low.

- When the next frame start trigger signal was received the trigger signal assigned to path 1 is found to be low. As a result, the frame start trigger does not trigger the loading of a new sequencer set. The parameter values of sequencer set 1 remain in the active set.

Note that this frame acquisition illustrates how sequencer sets can be used in succession.

A frame acquisition is carried out using the parameter values of sequencer set 1. The image data are processed and transmitted out of the camera.

The trigger signal assigned to path 1 stays low.

- The trigger signal assigned to path 1 goes high.
- When the next frame start trigger signal was received the trigger signal assigned to path 1 is found to be high. As a result, the frame start trigger triggers the loading of the next sequencer

set, that is sequencer set 2, into the active set. The parameter values for sequencer set 2 overwrite the parameter values for sequencer set 1 in the active set.

A frame acquisition is carried out using the parameter values of sequencer set 2. The image data are processed and transmitted out of the camera.

The trigger signal assigned to path 1 stays high.

- When the next frame start trigger signal was received the trigger signal assigned to path 1 is found to be high. As a result, the frame start trigger triggers the loading of the next sequencer set, that is sequencer set 3, into the active set. The parameter values for sequencer set 3 overwrite the parameter values for sequencer set 2 in the active set.

Note by comparison with previous frame start triggers that signal levels of the sequencer set trigger assigned to path 1 that occur occur between frame start triggers have no effect on sequencer set advance.

An image acquisition is carried out using the parameter values of sequencer set 3. The image data are processed and transmitted out of the camera.

The trigger signal assigned to path 1 goes low.

- The trigger signal assigned to path 1 goes high.
- When the next frame start trigger signal was received the trigger signal assigned to path 1 is found to be high. As a result, the frame start trigger triggers the loading of the next sequencer set, that is sequencer set 0, into the active set. The parameter values for sequencer set 0 overwrite the parameter values for sequencer set 3 in the active set. A new cycle of sequencer sets starts.

An frame acquisition is carried out using the parameter values of sequencer set 0. The image data are processed and transmitted out of the camera.

The trigger signal assigned to path 1 goes low.

- When the sequencer feature was disabled by setting the Sequencer Mode parameter value to Off, frame exposure and sensor readout were already complete but image transmission out of the camera was not. In this case, the complete frame will be transmitted even after the sequencer feature was disabled.

The previous sequencer parameter values, occurring in the active set before the sequencer feature was enabled, are loaded into the active set again, overwriting the parameter values of sequencer set 0.



**Use Case:** Synchronous cycling through sequencer sets, according to path 1, cycling not interrupted by reset

**Settings:** Acquisition Mode = Continuous  
 Trigger Mode for the frame start trigger = On  
 Trigger Activation for the frame start trigger: Rising Edge  
 Frame start triggers applied externally via Line 1  
 Synchronous triggers assigned to the GPIO lines, (configured for input):  
 Line 4 for path 1 triggers; sequencer set advance  
 Line 3 for path 0 triggers; reset of sequencer set advance

- = trigger signal generated externally
- ▼ = camera loads a sequencer set into the active set and thus makes it the current sequencer set
- P = current sequencer set; present in the active set immediately before the sequencer feature is enabled
- ⋮ = current sequencer set that is used for image acquisition; sequencer set was just loaded
- 0 = current sequencer set that is used for image acquisition; already present in the active set
- 1 = current sequencer set that is used for image acquisition; already present in the active set
- P = current sequencer set; sequencer set was already in the active set before it was overwritten by sequencer set -1; sequencer set was just loaded again
- ▨ = camera is waiting for a frame start trigger
- = frame exposure and readout
- ↓ = frame transmission

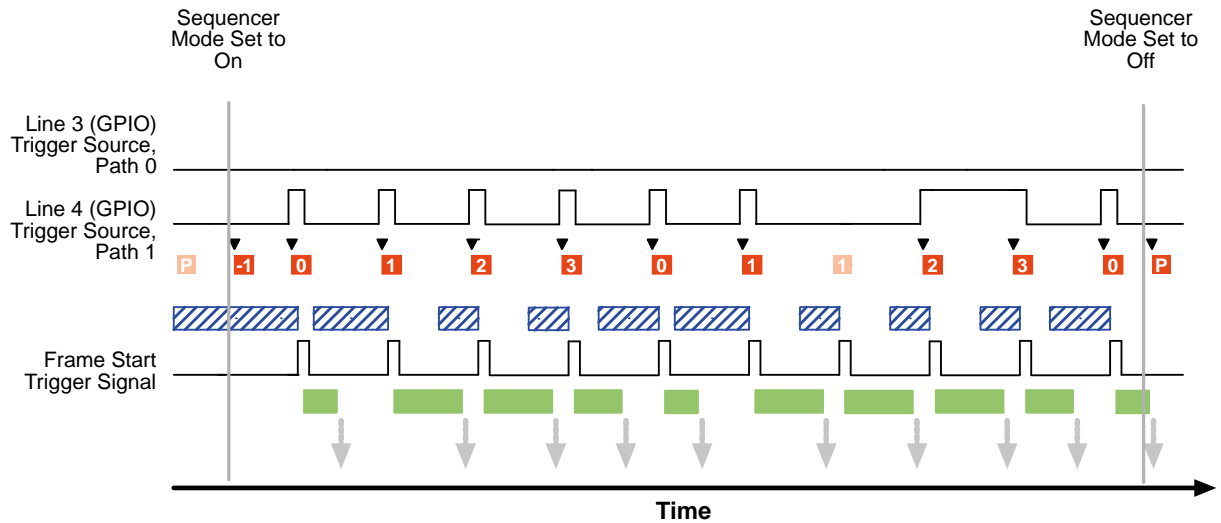

Fig. 88: Use Case 1 - Synchronous Cycling Through Sequencer Sets According to Path 1, No Reset

## Use Case 2 - Sequencer Set Advance Based on Counter 2 End, One Reset

Use case two is illustrated in Figure 89 on [page 245](#) and assumes that the following sequencer-related parameter values are set.

|               | Sequencer Set-related Settings       | Sequencer Set 0 | Sequencer Set 1 | Sequencer Set 2 | Sequencer Set 3 |
|---------------|--------------------------------------|-----------------|-----------------|-----------------|-----------------|
| <b>Path 0</b> | First sequencer set of path          | 0**             | 0**             | 0**             | 0**             |
|               | Next sequencer set after current one | 0**             | 0**             | 0**             | 0**             |
|               | Trigger source                       | Line 3 (GPIO)   | Line 3 (GPIO)*  | Line 3 (GPIO)*  | Line 3 (GPIO)*  |
|               | Trigger activation                   | Level High**    | Level High**    | Level High**    | Level High**    |
| <b>Path 1</b> | First sequencer set of path          | 0**             | 0**             | 0**             | 0**             |
|               | Next sequencer set after current one | 1**             | 2**             | 3**             | 0               |
|               | Trigger source                       | Counter 2 End   | Counter 2 End*  | Counter 2 End*  | Counter 2 End*  |
|               | Counter Duration                     | 1               | 1               | 2               | 1               |
|               | Trigger activation                   | Level High**    | Level High**    | Level High**    | Level High**    |

Table 51: Settings for Sequencer Operation According to Use Case 2.

\* Only one trigger source for a path allowed.

\*\*Applies Always, Not Only in this Example

### Use Case Two in Overview

Use case two demonstrates synchronous triggering and cycling through all the available four sequencer sets based on the Counter 2 End trigger source. An addition, one reset of the cycling occurs.

Sequencer set triggering according to path 0 is controlled by an external trigger via GPIO line Line 3, configured for input.

In this use case, the cycling through the sequencer sets according to path 1 is based on the Counter 2 End trigger source that in turn, is based on Counter 2 and its Counter Duration setting. The cycling is synchronous because the counting of Counter 2 is linked to the frame start triggers:

When a sequencer set has Counter 2 End as the trigger source for sequencer set advance, the related frame start triggers will be counted by Counter 2 and the sequencer set will be applied to the frame acquisitions. The same sequencer set will be applied to the following frame acquisitions until the set end of Counter 2 counting is reached. The end of counting is set by the Counter Duration parameter value applicable to Counter 2. When the end is reached, the counting will resume with number one for the next frame start trigger and will apply to the next sequencer set. As the receding series of frame acquisitions, before, the new series of frame acquisitions will be subject to Counter 2 counting and the Counter Duration parameter value.

## Use Case Two in Detail

Assuming that the sequencer sets are configured according to Table 51 on [page 241](#) and the camera is not acquiring images, the sequencer feature operates as follows:

- When the Sequencer Mode parameter value is set to On the sequencer feature becomes enabled for the application of sequencer sets during image acquisitions. The transitional "dummy" sequencer set with index number -1 is loaded into the active set, overwriting the previous sequencer parameter values (Section 7.7.2 on [page 222](#)).
- When a frame start trigger signal is received, sequencer set 0 is automatically loaded into the active set and is used for the image acquisition. The image data are processed and transmitted out of the camera.

The current frame start trigger count of Counter 2 is found to be 1. The Counter Duration setting, applicable to sequencer set 0 and defining the maximum Counter 2 count, is also found to be 1. Accordingly, the Counter 2 count related to sequencer set 0 has already reached its maximum and must start again with the next frame acquisition.

- When the next frame start trigger signal was received sequencer set 1 is loaded into the active set and is used for the image acquisition. The image data are processed and transmitted out of the camera.

Sequencer set 1 was loaded because the Counter 2 count for sequencer set 0 was found to already have reached its maximum allowed value in the preceding frame acquisition.

The current frame start trigger count of Counter 2 is found to be 1. The Counter Duration setting, applicable to sequencer set 1 and defining the maximum Counter 2 count, is also found to be 1. Accordingly, the Counter 2 count related to sequencer set 1 has already reached its maximum and must start again with the next frame acquisition.

- When the next frame start trigger signal was received sequencer set 2 is loaded into the active set and is used for the image acquisition. The image data are processed and transmitted out of the camera.

Sequencer set 2 was loaded because the Counter 2 count for sequencer set 1 was found to already have reached its maximum allowed value in the preceding frame acquisition.

The current frame start trigger count of Counter 2 is found to be 1. The Counter Duration setting, applicable to sequencer set 2 and defining the maximum Counter 2 count, is found to be 2. Accordingly, the Counter 2 count related to sequencer set 2 has not yet reached its maximum and can therefore continue counting with next frame acquisition.

- When the next frame start trigger signal was received sequencer set 2 was still present in the active set and is used for the image acquisition. The image data are processed and transmitted out of the camera.

Sequencer set 2 was used again because the Counter 2 count for sequencer set 2 was found not to already have reached its maximum allowed value in the preceding frame acquisition.

The current frame start trigger count of Counter 2 is found to be 2. The Counter Duration setting, applicable to sequencer set 2 and defining the maximum Counter 2 count, is also found to be 2. Accordingly, the Counter 2 count related to sequencer set 2 has now reached its maximum and must start again with the next frame acquisition.

- When the next frame start trigger signal was received sequencer set 3 is loaded into the active set and is used for the image acquisition. The image data are processed and transmitted out of the camera.

Sequencer set 3 was loaded because the Counter 2 count for sequencer set 2 was found to have reached its maximum allowed value in the preceding frame acquisition.

The current frame start trigger count of Counter 2 is found to be 1. The Counter Duration setting, applicable to sequencer set 3 and defining the maximum Counter 2 count, is found to be 1. Accordingly, the Counter 2 count related to sequencer set 3 has already reached its maximum and must start again with the next frame acquisition.

- When the next frame start trigger signal was received sequencer set 0 is loaded into the active set and is used for the image acquisition. The image data are processed and transmitted out of the camera.

Sequencer set 0 was loaded because the Counter 2 count for sequencer set 1 was found to already have reached its maximum allowed value in the preceding frame acquisition. With the use of sequencer set 0 a new cycle of sequencer sets has begun.

The current frame start trigger count of Counter 2 is found to be 1. The Counter Duration setting, applicable to sequencer set 0 and defining the maximum Counter 2 count, is found to be 1. Accordingly, the Counter 2 count related to sequencer set 0 has already reached its maximum and can therefore must start again with the next frame acquisition.

- When the next frame start trigger signal was received sequencer set 1 is loaded into the active set and is used for the image acquisition. The image data are processed and transmitted out of the camera.

Sequencer set 1 was loaded because the Counter 2 count for sequencer set 0 was found to already have reached its maximum allowed value in the preceding frame acquisition.

The current frame start trigger count of Counter 2 is found to be 1. The Counter Duration setting, applicable to sequencer set 1 and defining the maximum Counter 2 count, is also found to be 1. Accordingly, the Counter 2 count related to sequencer set 1 has already reached its maximum and must start again with the next frame acquisition.

- When the next frame start trigger signal was received sequencer set 2 is loaded into the active set and is used for the image acquisition. The image data are processed and transmitted out of the camera.

Sequencer set 2 was loaded because the Counter 2 count for sequencer set 1 was found to already have reached its maximum allowed value in the preceding frame acquisition.

The current frame start trigger count of Counter 2 is found to be 1. The Counter Duration setting, applicable to sequencer set 2 and defining the maximum Counter 2 count, is found to be 2. Accordingly, the Counter 2 count related to sequencer set 2 has not yet reached its maximum and can therefore must start again with the next frame acquisition.

- A trigger signal according to path 0 was received, resetting the sequencer set cycle.
- When the next frame start trigger signal was received sequencer set 0 is loaded into the active in accord with the preceding reset signal and is used for the image acquisition. The image data are processed and transmitted out of the camera.

The current frame start trigger count of Counter 2 is found to be 1. The Counter Duration setting, applicable to sequencer set 0 and defining the maximum Counter 2 count, is found to be 1. Accordingly, the Counter 2 count related to sequencer set 0 has already reached its maximum and must start again with the next frame acquisition.

- When the next frame start trigger signal was received sequencer set 1 is loaded into the active set and is used for the image acquisition. The image data are processed and transmitted out of the camera.

Sequencer set 1 was loaded because the Counter 2 count for sequencer set 0 was found to already have reached its maximum allowed value in the preceding frame acquisition.

The current frame start trigger count of Counter 2 is found to be 1. The Counter Duration setting, applicable to sequencer set 1 and defining the maximum Counter 2 count, is also found to be 1. Accordingly, the Counter 2 count related to sequencer set 1 has already reached its maximum and must start again with the next frame acquisition.

- When the Sequencer Mode parameter value is set to Off the sequencer feature becomes disabled for the application of sequencer sets during image acquisitions. The sequencer parameter values that were the current ones before the sequencer feature was enabled, are loaded into the active set again. The sequencer set 1 parameter values in the active set are overwritten.

**Use Case:** Synchronous cycling through sequencer sets, according to path 1, cycling interrupted by synchronous reset according to path 0

**Settings:** Acquisition Mode = Continuous  
 Trigger Mode for the frame start trigger = On  
 Trigger Activation for the frame start trigger: Rising Edge  
 Frame start triggers applied externally via Line 1  
 Synchronous trigger source for sequencer set advance: Counter 2 End  
 Synchronous trigger source for reset of sequencer set advance: GPIO line Line 3

- = trigger signal generated externally
- = counting of frame start triggers, counted by Counter 2 and limited by Counter Duration; number: current count
- = camera loads a sequencer set into the active set making it the current set
- = current sequencer set that is in the active set immediately before the sequencer feature is enabled
- = current sequencer set that is used for image acquisition; sequencer set was just loaded
- = current sequencer set that is used for image acquisition; already present in the active set
- = current sequencer set; was in the active set immediately before the sequencer feature was enabled
- = camera is waiting for a frame start trigger
- = frame exposure and readout
- = frame transmission

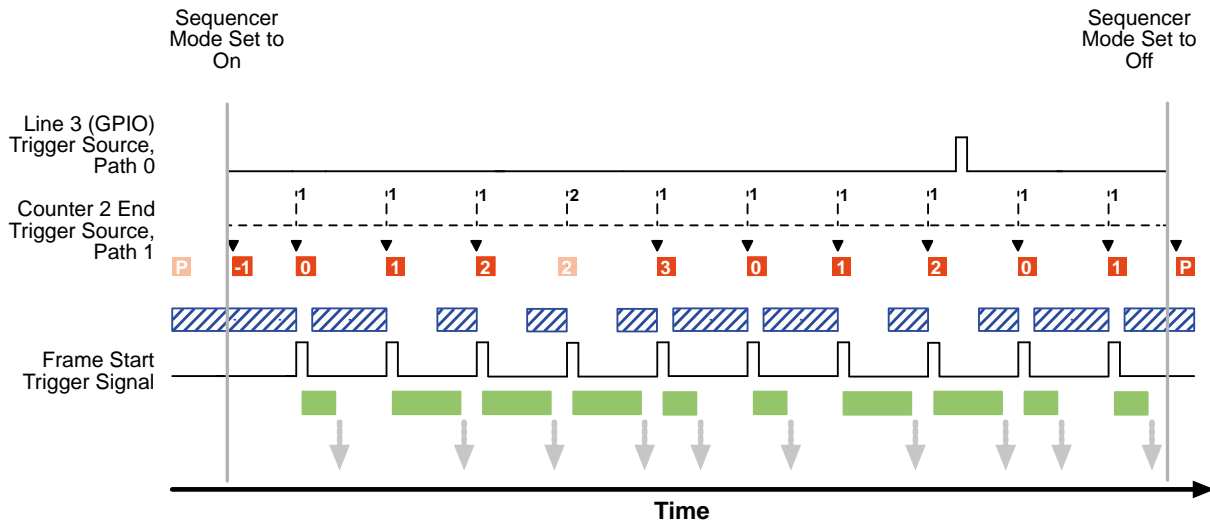

Fig. 89: Use Case 2 - Synchronous Cycling Through Sequencer Sets Based on Counter 2 End (Path 1), One Reset.

### Use Case 3 - Sequencer Set Advance based on a Software Signal, One Reset

Use case three is illustrated in Figure 90 on [page 249](#) and assumes that the following sequencer-related parameter values are set.

|               | Sequencer Set-related Settings       | Sequencer Set 0   | Sequencer Set 1    | Sequencer Set 2    | Sequencer Set 3    |
|---------------|--------------------------------------|-------------------|--------------------|--------------------|--------------------|
| <b>Path 0</b> | First sequencer set of path          | 0**               | 0**                | 0**                | 0**                |
|               | Next sequencer set after current one | 0**               | 0**                | 0**                | 0**                |
|               | Trigger source                       | Software Signal 1 | Software Signal 1* | Software Signal 1* | Software Signal 1* |
|               | Trigger activation                   | Level High**      | Level High**       | Level High**       | Level High**       |
| <b>Path 1</b> | First sequencer set of path          | 0**               | 0**                | 0**                | 0**                |
|               | Next sequencer set after current one | 1**               | 2**                | 3**                | 0                  |
|               | Trigger source                       | Software Signal 3 | Software Signal 3* | Software Signal 3* | Software Signal 3* |
|               | Trigger activation                   | Level High**      | Level High**       | Level High**       | Level High**       |

Table 52: Settings for Sequencer Operation According to Use Case 3.

\* Only one trigger source for a path allowed.

\*\*Applies Always, Not Only in this Example

### Use Case Three in Overview

Use case three demonstrates the use of software commands for completely asynchronous control of cycling through the available four sequencer sets and of cycling reset.

Software Signal 1 is the trigger source for path 0 (reset). Software Signal 3 is the trigger source for path 1 (advance). The triggering is asynchronous to the frame start triggers. In addition, delays of arbitrary duration are involved between issuing a trigger and it becoming effective. Accordingly, the resulting sequencer operation is characterized by some degree of chance.

## Use Case Three in Detail

Assuming that the sequencer sets are configured according to Table 52 on [page 246](#) and the camera is not acquiring images, the sequencer feature operates as follows:

- When the Sequencer Mode parameter value is set to On the sequencer feature becomes enabled for the application of sequencer sets during image acquisitions. The transitional "dummy" sequencer set with index number -1 is loaded into the active set, overwriting the previous sequencer parameter values (Section 7.7.2 on [page 222](#)).
- When a frame start trigger signal is received, sequencer set 0 is automatically loaded into the active set and is used for the image acquisition. The image data are processed and transmitted out of the camera.
- When the next frame start trigger signal was received sequencer set 0 was still present in the active set and is used for the image acquisition. The image data are processed and transmitted out of the camera.
- The first Software Signal 3 trigger is sent. It will, however, only later become effective.
- When the next frame start trigger signal was received sequencer set 0 was still present in the active set and is used for the image acquisition. The image data are processed and transmitted out of the camera. The Software Signal 3 trigger has not yet become effective.
- The first Software Signal 3 trigger becomes effective after some delay, loading sequencer set 1 into the active set.
- When the next frame start trigger signal was received sequencer set 1 is present in the active set and is used for the image acquisition. The image data are processed and transmitted out of the camera.
- The second Software Signal 3 trigger is sent. It will, however, only later become effective.
- The second Software Signal 3 trigger becomes effective after some delay, loading sequencer set 2 into the active set.
- When the next frame start trigger signal was received sequencer set 2 is present in the active set and is used for the image acquisition. The image data are processed and transmitted out of the camera.
- The third Software Signal 3 trigger is sent. It will, however, only later become effective.
- The fourth Software Signal 3 trigger is sent. It will, however, only later become effective.
- The third Software Signal 3 trigger becomes effective after some delay, loading sequencer set 3 into the active set.
- The fourth Software Signal 3 trigger becomes effective after some delay, loading sequencer set 0 into the active set, starting a new cycle of sequencer sets.
- When the next frame start trigger signal was received sequencer set 0 is present in the active set and is used for the image acquisition. The image data are processed and transmitted out of the camera. Note that sequencer set 3 was skipped for frame acquisition.
- The fifth Software Signal 3 trigger is sent. It will, however, only later become effective.
- When the next frame start trigger signal was received sequencer set 0 is present in the active set and is used for the image acquisition. The image data are processed and transmitted out of the camera.
- The fifth Software Signal 3 trigger becomes effective after some delay, loading sequencer set 1 into the active set.



- The first Software Signal 1 trigger is sent. It will, however, only later become effective.
- When the next frame start trigger signal was received sequencer set 1 is present in the active set and is used for the image acquisition. The image data are processed and transmitted out of the camera.
- The first Software Signal 1 trigger becomes effective after some delay, loading sequencer set 0 into the active set and thereby resetting the cycling through the sequencer sets.
- When the next frame start trigger signal was received sequencer set 0 is present in the active set and is used for the image acquisition. The image data are processed and transmitted out of the camera.
- When the next frame start trigger signal was received sequencer set 0 is present in the active set and is used for the image acquisition. The image data are processed and transmitted out of the camera.
- When the Sequencer Mode parameter value is set to Off the sequencer feature becomes disabled for the application of sequencer sets during image acquisitions. The sequencer parameter values that were the current ones before the sequencer feature was enabled, are loaded into the active set again. The sequencer set 0 parameter values in the active set are overwritten.

**Use Case:** Asynchronous cycling through sequencer sets, according to path 1, cycling interrupted by asynchronous reset according to path 0

**Settings:** Acquisition Mode = Continuous  
 Trigger Mode for the frame start trigger = On  
 Trigger Activation for the frame start trigger: Rising Edge  
 Frame start triggers applied externally via Line 1  
 Asynchronous trigger source for sequencer set advance: Software Signal 3  
 Asynchronous trigger source for reset of sequencer set advance: Software Signal 1

- = Software Signal trigger source (Software Signal 3) for asynchronous sequencer set advance
- = delay between sending the advance command and it becoming effective
- = Software Signal trigger source (Software Signal 1) for asynchronous reset of sequencer set advance
- = delay between sending the reset command and it becoming effective
- = trigger signal generated externally
- = camera loads a sequencer set into the active set making it the current set
- = current sequencer set that is in the active set immediately before the sequencer feature is enabled
- = current sequencer set that is used for image acquisition; sequencer set was just loaded
- = current sequencer set that is used for image acquisition; already present in the active set
- = current sequencer set; was in the active set before it was overwritten by sequencer set -1
- = camera is waiting for a frame start trigger
- = frame exposure and readout
- = frame transmission

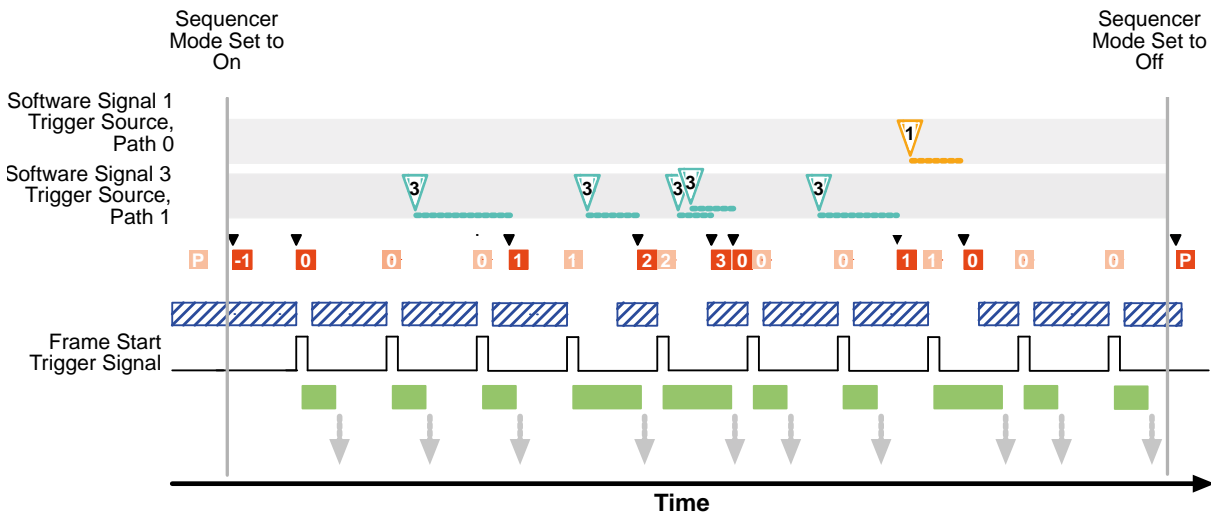

Fig. 90: Use Case 3 - Asynchronous Cycling Through Sequencer Sets According to Path 1, One Reset

## 7.8 Binning

For information about the availability of binning on a specific camera model, see Table 41 on [page 196](#) and Table 42 on [page 197](#).

The binning feature is usually only available on monochrome cameras.

For information about color binning, see Section 7.8.2 on [page 253](#).



- When vertical binning is used, vertical decimation is not available. When horizontal binning is used, horizontal decimation is not available.  
However: When vertical binning is used, horizontal decimation is available. When horizontal binning is used, vertical decimation is available.  
For more information about decimation, see Section 7.9.1 on [page 258](#).
- When binning is used, scaling is not available.  
For more information about scaling, see Section 7.10 on [page 263](#).

### 7.8.1 Binning on Monochrome Cameras

#### Normal Implementation

Binning increases the camera's response to light by summing the charges from adjacent pixels into one pixel. Two types of binning are available: vertical binning and horizontal binning.

With vertical binning, adjacent pixels from 2 rows, 3 rows, or a maximum of 4 rows in the imaging sensor array are summed and are reported out of the camera as a single pixel. [Figure 91](#) illustrates vertical binning.

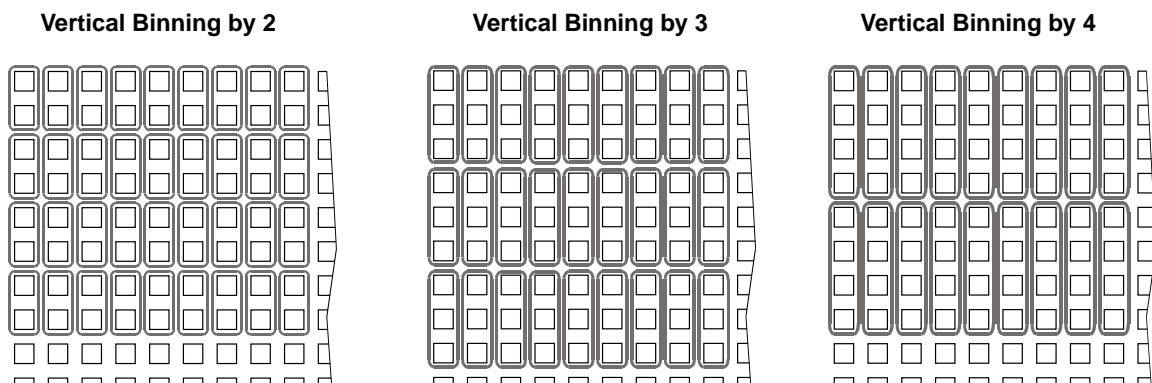

Fig. 91: Vertical Binning on Monochrome Cameras

With horizontal binning, adjacent pixels from 2 columns, 3 columns, or a maximum of 4 columns are summed and are reported out of the camera as a single pixel. [Figure 92](#) illustrates horizontal binning.

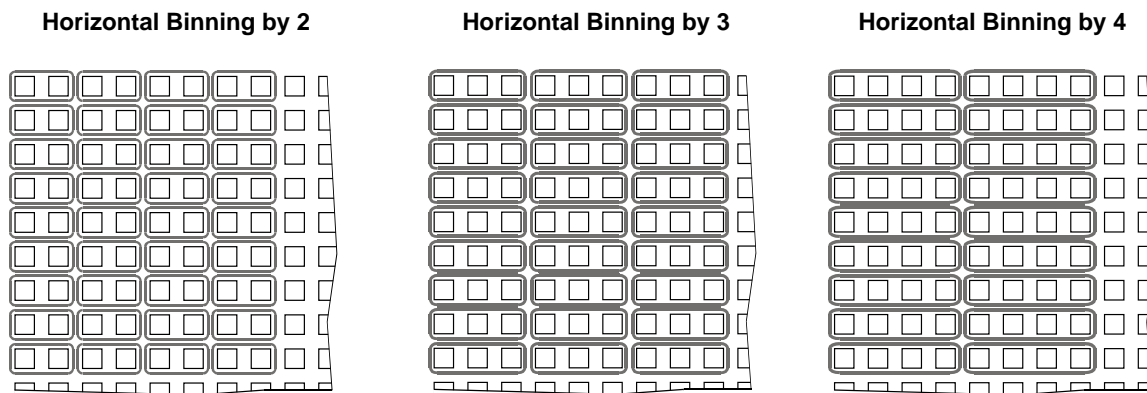

Fig. 92: Horizontal Binning on Monochrome Cameras

You can combine vertical and horizontal binning. This, however, can cause objects to appear distorted in the image. For more information about possible image distortion due to combined vertical and horizontal binning, see [Section 7.8.4](#) on [page 256](#).

### Particular Implementation for the acA1920-25um and acA2500-14um

For the acA1920-25um and acA2500-14um, vertical binning works in a different way:

- Vertical binning by 2 and by 4:  
The gray values of adjacent pixels from 2 rows or from 4 rows are **averaged**.  
As a consequence, the signal to noise ratio will be increased while the camera's response to light will not be increased.
- Vertical binning by 3:  
The gray values of adjacent pixels from 3 rows are combined.  
As a consequence, the signal to noise ratio will be decreased while the camera's response to light will be slightly increased.

We recommend using vertical binning by 2 or by 4.

### **Particular Implementation for the acA3800-14um**

Horizontal binning by 3 is not available for acA3800-14um cameras.

### **Particular Implementation with Binning Modes**

For the acA640-750um, acA800-510um, acA1300-200um, acA1920-40um, acA1920-150um, acA1920-155um, acA2040-55um, acA2040-120um, acA2440-35um, acA2440-75um, acA2500-60um you can choose between Summing and Averaging as binning modes. In these modes pixel gray values are added or averaged (arithmetic mean).

## 7.8.2 Binning on Color Cameras

For information about the availability of binning in color cameras, see Table 42 on [page 197](#).

### Normal Implementation

For color binning, pixel values for identical colors are binned vertically and/or horizontally.

For **vertical** color binning, the gray values of adjacent pixels of the same color from 2 rows, 3 rows, or a maximum of 4 rows in the imaging sensor array are **averaged** and are reported out of the camera as a single pixel. The number of binned pixels depends on the vertical color binning setting (see the example in Figure 93).

As the gray values are averaged during vertical color binning and not summed, the signal to noise ratio will be increased while the camera's response to light will not be increased.

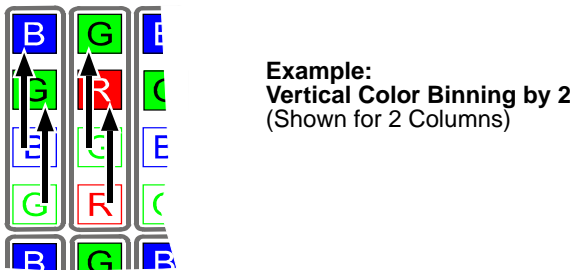

Fig. 93: Vertical Color Binning by 2

For **horizontal** color binning, the gray values of adjacent pixels of the same color from 2 columns, 3 columns, or a maximum of 4 columns in the imaging sensor array are **summed** and are reported out of the camera as a single pixel. The number of binned pixels depends on the horizontal color binning setting (see example in Figure 94).

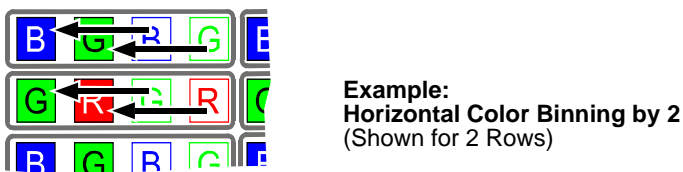

Fig. 94: Horizontal Color Binning by 2

## Combining Horizontal and Vertical Color Binning

You can combine vertical and horizontal color binning (see the example in Figure 95).

### Example: Horizontal and Vertical Color Binning by 2

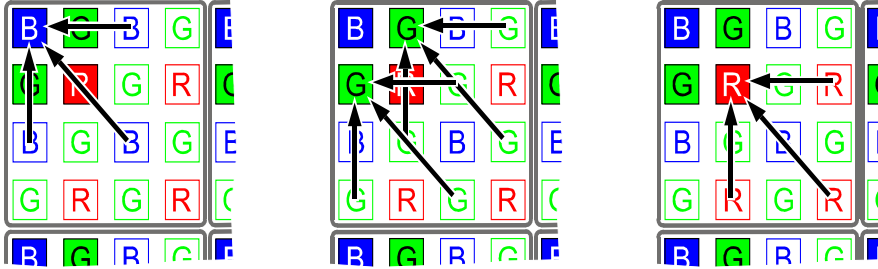

Fig. 95: Combining Vertical and Horizontal Color Binning

You can combine vertical and horizontal binning. This, however, may cause objects to appear distorted in the image. For more information about possible image distortion due to combined vertical and horizontal binning, see Section 7.8.4 on [page 256](#).

## 7.8.3 Setting Binning

You can enable vertical binning by setting the Binning Vertical parameter. Setting the parameter's value to 2, 3, or 4 enables vertical binning by 2, by 3, or by 4, respectively. Setting the parameter's value to 1 disables vertical binning.

You can enable horizontal binning by setting the Binning Horizontal parameter. Setting the parameter's value to 2, 3, or 4 enables horizontal binning by 2, by 3, or by 4, respectively. Setting the parameter's value to 1 disables horizontal binning.

You can set the Binning Vertical or the Binning Horizontal parameter value from within your application software by using the Basler pylon API. The following code snippet illustrates using the API to set the parameter values:

```
// Enable vertical binning by 2
camera.BinningVertical.SetValue( 2 );

// Enable horizontal binning by 4
camera.BinningHorizontal.SetValue( 4 );

// Disable vertical and horizontal binning
camera.BinningVertical.SetValue( 1 );
camera.BinningHorizontal.SetValue( 1 );
```

If your camera provides binning modes also set the binning mode to summing or averaging for horizontal and vertical binning:

```
// Enable summing for horizontal binning
camera.BinningHorizontalMode.SetValue(BinningHorizontalMode_Summing);
BinningHorizontalModeEnums
e = camera.BinningHorizontalMode.GetValue();

// Enable averaging for horizontal binning
camera.BinningHorizontalMode.SetValue(BinningHorizontalMode_Averaging);
BinningHorizontalModeEnums
e = camera.BinningHorizontalMode.GetValue();

// Enable summing for vertical binning
camera.BinningVerticalMode.SetValue(BinningVerticalMode_Summing);
BinningVerticalModeEnums e = camera.BinningVerticalMode.GetValue();

// Enable averaging for vertical binning
camera.BinningVerticalMode.SetValue(BinningVerticalMode_Averaging);
BinningVerticalModeEnums e = camera.BinningVerticalMode.GetValue();
```

You can also use the Basler pylon Viewer application to easily set the parameters.

For more information about the pylon API and the pylon Viewer, see Section 3.1 on [page 62](#).



## 7.8.4 Considerations When Using Binning

### Increased Response to Light

Using binning can greatly increase the camera's response to light (sensitivity). When binning is enabled, acquired images may look overexposed. If this is the case, you can reduce the lens aperture, the intensity of your illumination, the camera's exposure time setting, or the camera's gain setting.

When using vertical binning on monochrome cameras, the limits for the minimum gain settings are automatically lowered. This allows you to use lower gain settings than would otherwise be available.

For the lowered limits for the minimum gain settings, see Section 7.2.2 on [page 200](#).

### Decreased Resolution

Using binning effectively decreases the resolution of the camera's imaging sensor. For example, the sensor in the acA640-90um camera normally has a resolution of 659 (H) x 494 (V). If you set this camera to use horizontal binning by 3 and vertical binning by 3, the effective resolution of the sensor is decreased to 219 (H) by 164 (V).

### Binning's Effect on ROI Settings

When you have the camera set to use binning, keep in mind that the settings for your image region of interest (ROI) will refer to the binned rows and columns in the sensor and not to the physical rows and columns in the sensor as they normally would. Another way to think of this is by using the concept of a "virtual sensor".

For example, assume that you are using an acA640-90um camera set for 3 by 3 binning as described above. In this case, you would act as if you were actually working with a 219 column by 164 row sensor when setting your ROI parameters. The maximum ROI width would be 219 and the maximum ROI height would be 164. When you set the Offset X and the Width for the ROI, you will be setting these values in terms of virtual sensor columns. And when you set the Offset Y and the Height for the ROI, you will be setting these values in terms of virtual sensor rows and columns.

For more information about the image region of interest (ROI) feature, see Section 7.6 on [page 213](#).

### Effective Image ROI and Effective Offset X and Offset Y

Note that neither width nor height of the (physical) sensor used in the above example were evenly divisible by 3. Each division left a remainder of two. Therefore, the sensor resolution actually used for binning was 657 (H) x 492 (V), and the remaining two columns (numbers 658 and 659) and rows (numbers 493 and 494) were excluded from binning and image transmission.

In other words, and expressed in terms of the physical sensor: An effective image ROI was formed whose resolution of 657 (H) x 492 (V) was smaller than the resolution of the originally set image ROI. Only the pixels within the effective image ROI were used for binning. And only these pixels

define the "virtual sensor" for the transmitted image. The "excess" columns and rows were excluded from binning and from the virtual sensor.

Carry out the following routine whenever setting binning values:

**To ensure that the scene of interest appears fully on the binned image:**

1. Set the binning as desired.  
The related spatial information (offset, ROI width, ROI height) is expressed in terms of virtual sensor rows and columns.
2. Acquire an image.
3. Check, whether the scene you want to image is fully imaged.
4. If necessary, adjust the settings for the virtual rows or columns to fully image the scene of interest.

### **Possible Image Distortion**

Objects will only appear undistorted in the image, if the numbers of binned lines and columns are equal. With all other combinations, the imaged objects will appear distorted. If, for example, vertical binning by 2 is combined with horizontal binning by 4 the widths of the imaged objects will appear shrunk by a factor of 2 compared to the heights.

If you want to preserve the aspect ratios of imaged objects when using binning, you must use vertical and horizontal binning where equal numbers of lines and columns are binned, e.g. vertical binning by 3 combined with horizontal binning by 3.

## 7.9 Decimation

The decimation feature lets you perform vertical and/or horizontal sub-sampling of an acquired frame.

|   |  |
|---|--|
|  | <ul style="list-style-type: none"> <li>■ When vertical decimation is used, vertical binning is not available. When horizontal decimation is used, horizontal binning is not available.<br/>However: When vertical decimation is used, horizontal binning is available. When horizontal decimation is used, vertical binning is available.<br/>For more information about decimation, see Section 7.9.1 on <a href="#">page 258</a>.</li> <li>■ When decimation is used, scaling is not available.<br/>For more information about scaling, see Section 7.10 on <a href="#">page 263</a>.</li> </ul> |
|---|--|

### 7.9.1 Decimation Vertical (acA3800-14 and acA4600-10 Only)

The decimation vertical feature lets you specify the extent of vertical sub-sampling of the acquired frame, i.e. you can define rows that you want to be left out from transmission.

The acA3800-14 and acA4600-10 cameras support decimation in vertical direction.

#### Examples

(Blue rows will be transmitted):

If vertical decimation is set to

- 1: the complete frame will be transmitted out of the camera (no sub-sampling is realized); see [Figure 96](#).  
This is valid for mono and color cameras.
- 2 for mono cameras: only every second row of the acquired frame will be transmitted out of the camera ([Figure 97](#)).
- 2 for color cameras: only every second pair of rows of the acquired frame will be transmitted out of the camera ([Figure 98](#)).

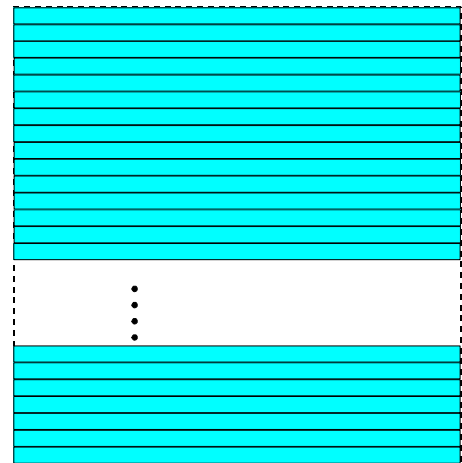

Fig. 96: Decimation Disabled

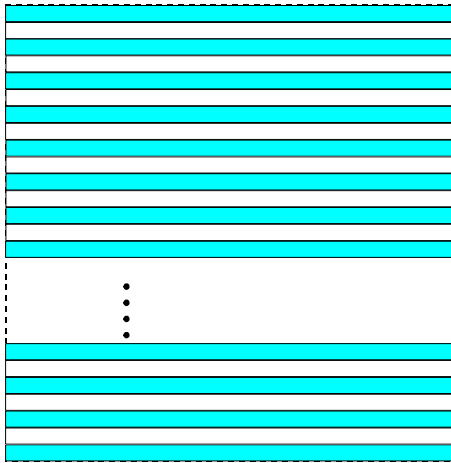

Fig. 97: Decimation of 2 (Mono Cameras)

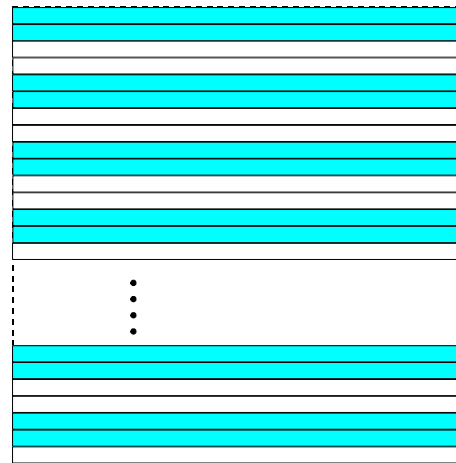

Fig. 98: Decimation of 2 (Color Cameras)

By using the vertical decimation feature, you can increase the frame rate of the camera.



#### ROI height

If you use the Vertical Decimation feature and you set the decimation parameter back to 1 to deactivate vertical decimation, the ROI height can be smaller than the maximum possible width due to rounding errors.

In this case you can manually set the ROI width back to the maximum possible height.

## Setting Vertical Decimation

You can enable vertical decimation for the acA2000-165 and acA2040-90 cameras by setting the Decimation Vertical parameter. The parameter value can be set to 1, 2, and 4. Setting the parameter value to 1 disables vertical decimation.

You can set the Decimation Vertical parameter value from within your application software by using the Basler pylon API. The following code snippet illustrates using the API to set the parameter values:

```
// Enable Vertical Decimation by 2
camera.DecimationVertical.SetValue(2);

// Disable Vertical Decimation
camera.DecimationVertical.SetValue(1);
```

You can also use the Basler pylon Viewer application to easily set the parameters.

For more information about the pylon API and the pylon Viewer, see Section 3.1 on [page 62](#).

## Vertical Decimation's Effect on ROI Settings

If vertical decimation is activated, the camera automatically adapts the ROI settings to the modified image size based on the formulas below.

For evaluating the new ROI height, the camera takes into account the number of physical lines that are between the first transmitted line (L1) and the last transmitted line (Ln), i.e. the so-called covered lines (see Figure 99). The line Ln + 1 in our example would not be part of the covered lines when the decimation feature is activated.

Calculating the **covered lines** (C)

- For **mono** cameras:  
 $(C) = H_{old} \times D_{old} - D_{old} + 1$
- For **color** cameras:  
 $(C) = H_{old} \times D_{old} - 2 \times D_{old} + 2$

As soon as the covered lines are determined, the camera calculates the new ROI height:

- For **mono** cameras:  
 $New\ ROI\ height = Round\ up\ (C / D_{new})$
- For **color** cameras:  
 $New\ ROI\ height = 2 \times Round\ up\ ((C / 2) / D_{new})$

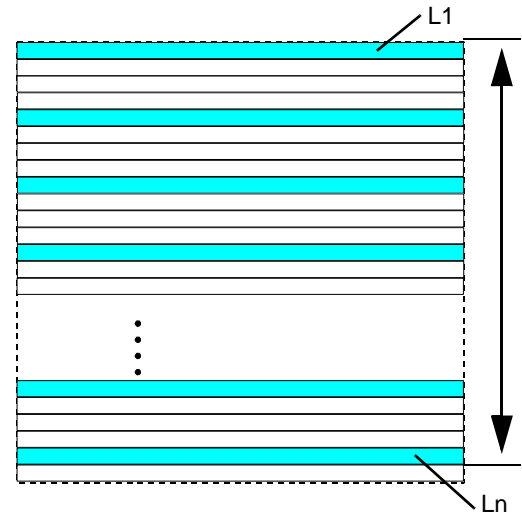

Fig. 99: Covered Lines (Mono Camera)

$C$  = Coverage  
 $D_{new}$  = New decimation value  
 $D_{old}$  = Old decimation value  
 $H_{new}$  = New ROI height  
 $H_{old}$  = Old ROI height



If you use the decimation vertical feature and you reset the decimation vertical parameter back to 1, i.e. you deactivate vertical decimation, the ROI height can be smaller than the maximum possible height (determined by the pixel resolution in vertical direction).

In this case you can manually set the ROI height back to the maximum possible height.

## 7.9.2 Decimation Horizontal (acA3800-14 and acA4600-10 Only)

The Horizontal Decimation feature (sub-sampling in horizontal direction) lets you specify the extent of horizontal sub-sampling of the acquired frame, i.e. you can define pixel columns that you want to be left out from transmission.

In contrast to vertical decimation, the frame rate will not increase when using horizontal decimation.



### ROI width

If you use the Horizontal Decimation feature and you set the decimation parameter back to 1 to deactivate horizontal decimation, the ROI width can be smaller than the maximum possible width due to rounding errors.

In this case you can manually set the ROI width back to the maximum possible width.

### Setting Horizontal Decimation

You can enable Horizontal decimation by setting the DecimationHorizontal parameter. Setting the parameter's value to 1 disables horizontal decimation.

You can set the DecimationHorizontal parameter value from within your application software by using the Basler pylon API. The following code snippet illustrates using the API to set the parameter value:

```
// Enable Horizontal Decimation by 8
Camera.DecimationHorizontal.SetValue(8);

// Disable Vertical Decimation
Camera.DecimationHorizontal.SetValue(1);
```

You can also use the Basler pylon Viewer application to easily set the parameter.

## 7.9.3 Considerations When Using Decimation

### Reduced Resolution

Using vertical decimation effectively reduces the vertical resolution of the camera's imaging sensor.

Likewise, horizontal decimation, effectively reduces the horizontal resolution of the camera's imaging sensor.

### Image Distortion

When only vertical decimation is used, the imaged objects will appear shrunk in vertical direction. If, for example, vertical decimation is set to 2, the imaged objects will appear shrunk by a factor of 2 compared to the horizontal direction and compared to an image without decimation. Likewise, horizontal decimation will shrink a frame in horizontal direction.

### Binning and Vertical Decimation

If vertical binning is used, vertical decimation is automatically disabled, and vice versa, i.e. if vertical decimation is used, vertical binning is disabled.

Horizontal binning works independently from the decimation feature.

## 7.10 Scaling

For information about the availability of the scaling feature on a specific camera model, see Table 41 on [page 196](#) and Table 42 on [page 197](#).



When scaling is used, binning and decimation are not available.

For more information about binning, see Section 7.8 on [page 250](#).

For more information about decimation, see Section 7.9 on [page 258](#).

The scaling feature allows you to shrink the size of a frame and to expand a shrunk frame up to its original size. Thereby, pixel values are added and averaged as required to map them from one (current) frame to the virtual pixels of the other frame. The scaling feature does not allow to expand a shrunk frame beyond its original size.

When using the scaling feature, a factor is applied to the width of the current frame (horizontal scaling). A factor of 1.0 causes no change to the original size of a frame. A factor less than 1.0 causes the width of the frame to shrink.

When horizontal scaling is applied, the scaling feature automatically applies the same factor to the height of the frame (vertical scaling). Thereby, the aspect ratio of the original frame is preserved.

By applying a factor that is greater than the previous one but still below 1.0, you can expand the size of the shrunk frame up to its original size (factor 1.0).

The factors available for scaling obey the following:

ORW: original ROI width [pixels]

SRW: scaled ROI width [pixels]

DSC =  $16/x$ ; where  $x$  is any natural number ranging from 16 to 128.

Accordingly, the factors range from 1.0 (no shrinking) to 0.125 (most extreme shrinking).

The scaled ROI width calculates as:

$SRW \text{ [pixels]} = (ORW \times DSC) - 2$



Frequently, scaling involves the rounding of frame dimensions. The rounding effects will be cumulative when applying a sequence of different scaling factors. When reversing the scaling, e.g. to return to a previous frame size, the frame dimensions lost during rounding are not restored. Accordingly, the previous frame size will not exactly be reached.

You can correct for the cumulative rounding losses by setting the previous frame size manually. Alternatively, instead of applying one scaling factor immediately after another, you can in between return to a "reference" frame size, e.g. to full resolution, and set the frame size manually to correct for rounding errors.



## Setting Scaling

You can use the scaling feature by setting the `ScalingHorizontal` parameter. value from within your application software by using the Basler pylon API. The following code snippet illustrates using the API to set the parameter value. The example illustrates setting the width of the current frame to one half of the original length:

```
// Set horizontal scaling
camera.ScalingHorizontal.SetValue(0.5);
double d = camera.ScalingHorizontal.GetValue();
```

You can also use the Basler pylon Viewer application to easily set the parameters.

For more information about the pylon API and the pylon Viewer, see Section 3.1 on [page 62](#).

## 7.10.1 Considerations When Using Scaling

### Scaling's Effect on ROI Settings

When you have the camera set to use scaling, keep in mind that the settings for your image region of interest (ROI) will refer to the rows and columns of the modified frame and not to the physical rows and columns in the sensor as they normally would. Another way to think of this is by using the concept of a "virtual sensor".

For example, assume that you are using an acA3800-14um camera with a scaling factor of 0.5 applied to full resolution (3840 × 2748 pixels). In this case, you would act as if you were actually working with a 1918 column by 1372 row sensor when setting your ROI parameters. The maximum ROI width would be 219 and the maximum ROI height would be 164. When you set the Offset X and the Width for the ROI, you will be setting these values in terms of virtual sensor columns. And when you set the Offset Y and the Height for the ROI, you will be setting these values in terms of virtual sensor rows and columns.

For more information about the image region of interest (ROI) feature, see Section 7.6 on [page 213](#).

## 7.11 Mirror Image

### 7.11.1 Reverse X

For information about the availability of Reverse X on a specific camera model, see Table 41 on [page 196](#) and Table 42 on [page 197](#).

#### Normal Implementation

The Reverse X feature is a horizontal mirror image feature. When the Reverse X feature is enabled, the pixel values for each line in a captured image will be swapped end-for-end about the line's center. This means that for each line, the value of the first pixel in the line will be swapped with the value of the last pixel, the value of the second pixel in the line will be swapped with the value of the next-to-last pixel, and so on.

[Figure 100](#) shows a normal image on the left and an image captured with Reverse X enabled on the right.

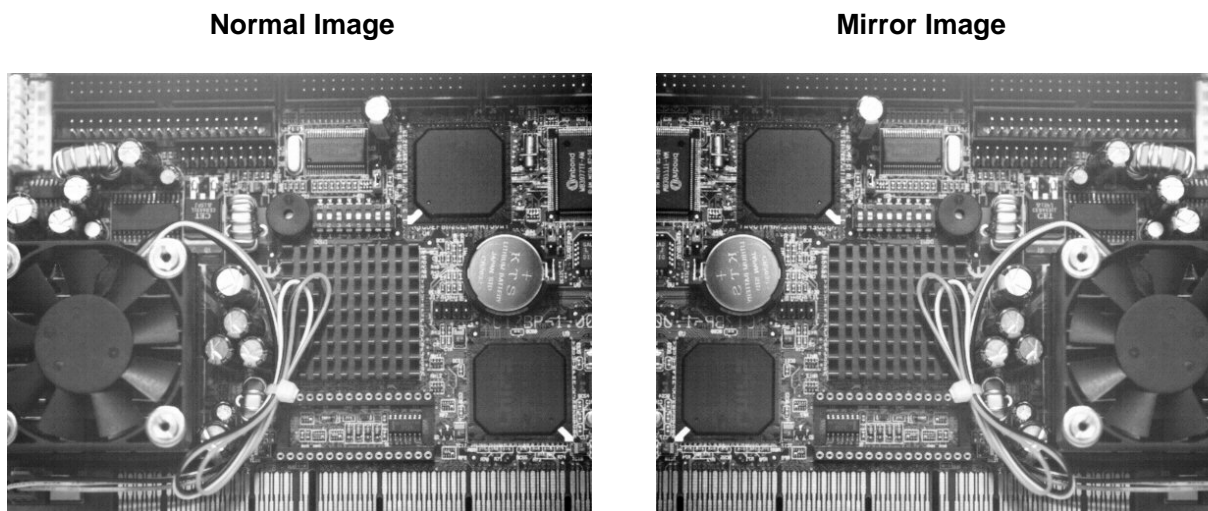

Fig. 100: Reverse X Mirror Imaging

## Using ROIs with Reverse X

You can use the image ROI feature when using the Reverse X feature. Note, however, that the position of an ROI relative to the sensor remains the same regardless of whether or not the Reverse X feature is enabled (see [Figure 101](#)).

As a consequence, an ROI will display different images depending on whether or not the Reverse X feature is enabled.

Auto function ROIs will behave analogously to image ROIs.

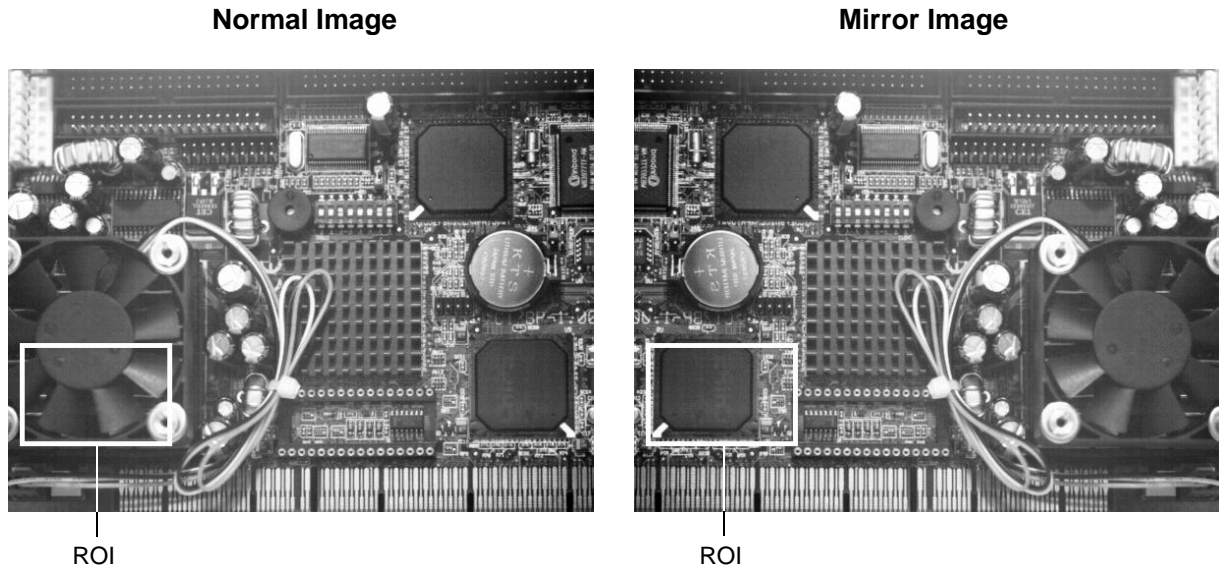

Fig. 101: Using an ROI with Reverse X Mirror Imaging



For color cameras, provisions are made ensuring that the effective color filter alignment remains constant for normal and mirror images, that is, the same alignment applies to normal and mirror images.

For more information about auto functions, see Section 7.15 on [page 299](#).

## Particular Implementation with Variable Effective Bayer Filter Alignments

For the acA640-750uc, acA800-510uc, acA1300-200uc, acA1920-40uc, acA1920-150uc, acA1920-155uc, acA2040-55uc, acA2040-120uc, acA2440-35uc, acA2440-75uc, acA2500-60uc the effective Bayer filter alignments vary when Reverse X is used.

The Bayer filter alignments given in Section 1.3 on [page 3](#) and Table 38 on [page 195](#) refer to the physical Bayer filter alignments with respect to the sensors' pixels. The physical alignments also apply to the images, when mirror image features are not enabled.

However, when mirror image features are enabled, effective alignments apply that differ systematically from the physical alignments. And accordingly, the related pixel formats apply. For example, when you use a camera with BG physical alignment and only ReverseX enabled, the pixels of the image are based on an effective GB alignment and the Bayer GB pixel formats apply.

| Physical Bayer Filter Alignment | Effective Bayer Filter Alignment |                       |                       |                               |
|---------------------------------|----------------------------------|-----------------------|-----------------------|-------------------------------|
|                                 | No Mirror Image Feature Enabled  | Only ReverseX Enabled | Only ReverseY Enabled | ReverseX and ReverseY Enabled |
| BG                              | BG                               | GB                    | GR                    | RG                            |
| RG                              | RG                               | GR                    | GB                    | BG                            |

Table 53: Effective Bayer Filter Alignments for Reverse X and for Reverse X and Y Combined

Note: When ReverseX and ReverseY are used at the same time the resulting effective alignment does not depend on the sequence of enabling.

## Setting Reverse X

You can enable or disable the ReverseX feature by setting the ReverseX parameter value. You can set the parameter value from within your application software by using the Basler pylon API. The following code snippet illustrates using the API to set the parameter value:

```
// Enable reverse X
camera.ReverseX.SetValue(true);
```

You can also use the Basler pylon Viewer application to easily set the parameter.

For more information about the pylon API and the pylon Viewer, see Section 3.1 on [page 62](#).

## 7.11.2 Reverse Y

For information about the availability of ReverseY on a specific camera model, see Table 41 on [page 196](#) and Table 42 on [page 197](#).

### Normal Implementation

The ReverseY feature is a vertical mirror image feature. When the reverse Y feature is enabled, the lines in a captured image will be swapped top-to-bottom. This means that the top line, in the image will be swapped with the bottom line, the next-to-top line will be swapped with the next-to-bottom line, and so on.

[Figure 102](#) shows a normal image on the left and, and an image captured with ReverseY enabled on the right.

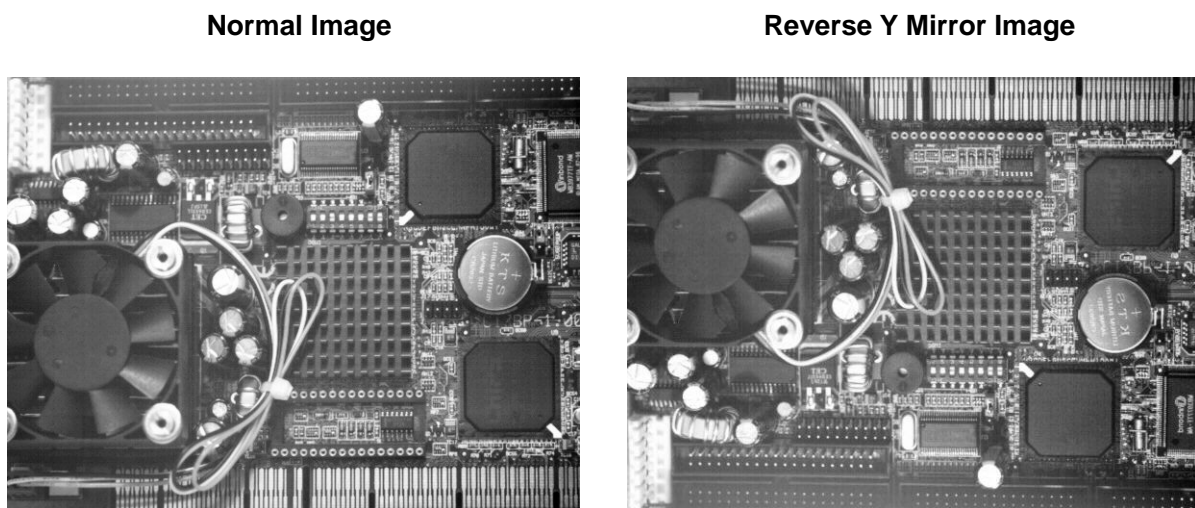

Fig. 102: Reverse Y Mirror Imaging

### Using ROIs with Reverse Y

You can use the ROI feature when using the Reverse X feature. Note, however, that the position of an ROI relative to the sensor remains the same regardless of whether or not the Reverse Y feature is enabled (see [Figure 103](#)).

As a consequence, an image ROI will display different images depending on whether or not the Reverse Y feature is enabled.

Auto function ROIs will behave analogously to image ROIs.

Normal Image

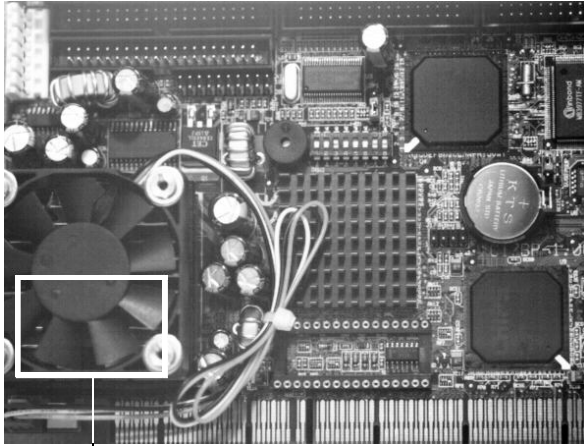

ROI

Mirror Image

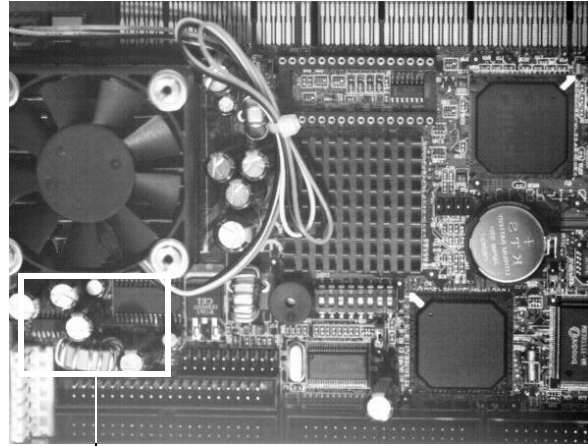

ROI

Fig. 103: Using an ROI with Reverse Y Mirror Imaging



For color cameras, provisions are made ensuring that the effective color filter alignment will be constant for normal and mirror images.

For more information about auto functions, see Section 7.15 on [page 299](#).

### Particular Implementation with Variable Effective Bayer Filter Alignments

For the acA640-750uc, acA800-510uc, acA1300-200uc, acA1920-40uc, acA1920-150uc, acA1920-155uc, acA2040-55uc, acA2040-120uc, acA2440-35uc, acA2440-75uc, acA2500-60uc the effective Bayer filter alignments vary when Reverse Y is used.

The Bayer filter alignments given in Section 1.3 on [page 3](#) and Table 38 on [page 195](#) refer to the physical Bayer filter alignments with respect to the sensors' pixels. The physical alignments also apply to the images, when mirror image features are not enabled.

However, when mirror image features are enabled, effective alignments apply that differ systematically from the physical alignments. And accordingly, the related pixel formats apply. For example, when you use a camera with BG physical alignment and only Reverse Y enabled, the pixels of the image are based on an effective GR alignment and the Bayer GR pixel formats apply.

| Physical Bayer Filter Alignment | Effective Bayer Filter Alignment |                        |                                 |
|---------------------------------|----------------------------------|------------------------|---------------------------------|
|                                 | No Mirror Image Feature Enabled  | Only Reverse Y Enabled | Reverse X and Reverse Y Enabled |
| BG                              | BG                               | GR                     | RG                              |
| GB                              | GB                               | RG                     | GR                              |
| RG                              | RG                               | GB                     | BG                              |

Table 54: Effective Bayer Filter Alignments for Reverse Y and for Reverse X and Y Combined

Note: When Reverse X and Reverse Y are used at the same time the resulting effective alignment does not depend on the sequence of enabling.

## Setting Reverse Y

You can enable or disable the Reverse Y feature by setting the ReverseY parameter value. You can set the parameter value from within your application software by using the Basler pylon API. The following code snippet illustrates using the API to set the parameter value:

```
// Enable reverse Y
camera.ReverseY.SetValue(true);
```

You can also use the Basler pylon Viewer application to easily set the parameter.

For more information about the pylon API and the pylon Viewer, see Section 3.1 on [page 62](#).

## 7.12 Luminance Lookup Table

### Normal Implementation

#### Using the Luminance Lookup Table for Cameras with 12 bit ADC Data and Pixel Format Set for 12 Bit Output

Whenever the camera is set for a 12 bit pixel format (e.g., Mono 12), the 12 bits transmitted out of the camera for each pixel normally represent the 12 bits reported by the camera's ADC. The luminance lookup table feature lets you use a custom 12 bit to 12 bit lookup table to map the 12 bits reported out of the ADC to 12 bits that will be transmitted by the camera.

The lookup table is essentially just a list of 4096 values, however, not every value in the table is actually used. If we number the values in the table from 0 through 4095, the table works like this:

- The number at location 0 in the table represents the 12 bits that will be transmitted out of the camera when the ADC reports that a pixel has a value of 0.
- The numbers at locations 1 through 7 are not used.
- The number at location 8 in the table represents the 12 bits that will be transmitted out of the camera when the ADC reports that a pixel has a value of 8.
- The numbers at locations 9 through 15 are not used.
- The number at location 16 in the table represents the 12 bits that will be transmitted out of the camera when the ADC reports that a pixel has a value of 16.
- The numbers at locations 17 through 23 are not used.
- The number at location 24 in the table represents the 12 bits that will be transmitted out of the camera when the ADC reports that a pixel has a value of 24.
- And so on.

As you can see, the table does not include a user defined 12 bit value for every pixel value that the sensor can report. So what does the camera do when the ADC reports a pixel value that is between two values that have a defined 12 bit output? In this case, the camera performs a straight line interpolation to determine the value that it should transmit. For example, assume that the ADC reports a pixel value of 12. In this case, the camera would perform a straight line interpolation between the values at location 8 and location 16 in the table. The result of the interpolation would be reported out of the camera as the 12 bit output.

Another thing to keep in mind about the table is that location 4088 is the last location that will have a defined 12 bit value associated with it. (Locations 4089 through 4095 are not used.) If the ADC reports a value above 4088, the camera will not be able to perform an interpolation. In cases where the ADC reports a value above 4088, the camera simply transmits the 12 bit value from location 4088 in the table.

The advantage of the luminance lookup table feature is that it allows a user to customize the response curve of the camera. The graphs below show the effect of two typical lookup tables. The first graph is for a lookup table where the values are arranged so that the output of the camera increases linearly as the digitized sensor output increases. The second graph is for a lookup table where the values are arranged so that the camera output increases quickly as the digitized sensor



output moves from 0 through 2048 and increases gradually as the digitized sensor output moves from 2049 through 4096.

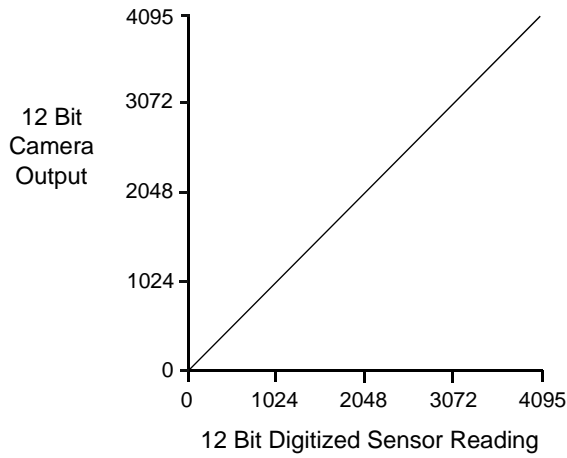

Fig. 104: Lookup Table with Values Mapped in a Linear Fashion

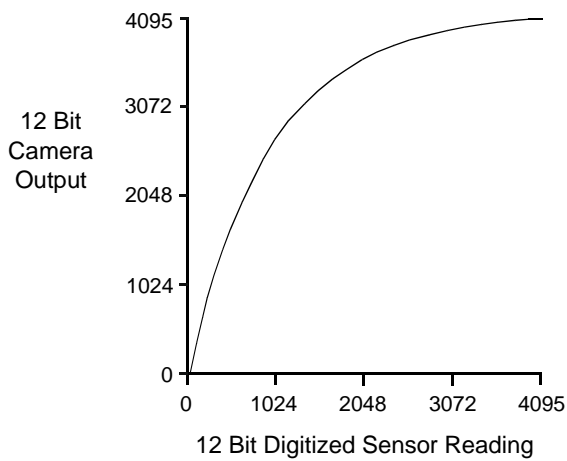

Fig. 105: Lookup Table with Values Mapped for Higher Camera Output at Low Sensor Readings

## Using the Luminance Lookup Table for Cameras with 12 bit ADC Data and Pixel Format Set for 8 Bit Output

As mentioned above, when the camera is set for a pixel format where it outputs 12 bits, the lookup table is used to perform a 12 bit to 12 bit conversion. But the lookup table can also be used in 12 bit to 8 bit fashion. To use the table in 12 bit to 8 bit fashion, you enter 12 bit values into the table and enable the table as you normally would. But instead of setting the camera for a pixel format that results in a camera output with 12 bits effective, you set the camera for a pixel format that results in 8 bit output (e.g., Mono 8). In this situation, the camera will first use the values in the table to do a 12 bit to 12 bit conversion. It will then drop the 4 least significant bits of the converted value and will transmit the 8 most significant bits.

### Particular Implementation for the acA640-750, acA800-510, acA1300-200, acA1920-150, and acA2500-60

For cameras providing 10 bit as the highest pixel format bit depth, the luminance lookup table values must be entered as 10 bit values.

## Changing the Values in the Luminance Lookup Table and Enabling the Table

You can change the values in the luminance lookup table (LUT) and enable the use of the lookup table. The following example refers to using 12 bit ADC data:

- Use the LUT Selector to select a lookup table. (Currently there is only one lookup table available, i.e., the "luminance" lookup table described above.)
- Use the LUT Index parameter to select a value in the lookup table. The LUT Index parameter selects the value in the table to change. The index number for the first value in the table is 0, for the second value in the table is 1, for the third value in the table is 2, and so on.
- Use the LUT Value parameter to set the selected value in the lookup table.
- Use the LUT Index parameter and LUT value parameters to set other table values as desired.
- Use the LUT Enable parameter to enable the table.

You can set the LUT Selector, the LUT Index parameter and the LUT Value parameter from within your application software by using the Basler pylon API. The following code snippet illustrates using the API to set the selector and the parameter values:

```
// Select the lookup table
camera.LUTSelector.SetValue(LUTSelector_Luminance);

// Write a lookup table to the device.
// The following lookup table causes an inversion of the sensor values
// ( bright -> dark, dark -> bright )
for ( int i = 0; i < 4096; i += 8 )
{
    camera.LUTIndex.SetValue( i );
    camera.LUTValue.SetValue( 4095 - i );
}
```

```
// Enable the lookup table  
camera.LUTEnable.SetValue(true);
```

You can also use the Basler pylon Viewer application to easily set the parameters.

For more information about the pylon API and the pylon Viewer, see Section 3.1 on [page 62](#).

## 7.13 Gamma Correction

The gamma correction feature lets you modify the brightness of the pixel values output by the camera's sensor to account for a non-linearity in the human perception of brightness. For color cameras, gamma correction is always performed in the RGB color space.



If color binning is enabled for the acA1920-25uc, gamma correction will be applied after color binning was performed. For more information about color binning, see Section 7.8.2 on [page 253](#).



When using a light source preset for a color camera, a gamma correction value of approximately 0.4 will automatically be applied, corresponding to an sRGB gamma correction value.

Under these circumstances, we recommend not to explicitly set a gamma correction value. If you do nonetheless you will alter the effect of the selected light source preset.

For more information about light source presets, see Section 7.3.3 on [page 204](#).

To accomplish gamma correction, a gamma correction value ( $\gamma$ ) is applied to the pixel value of each pixel according to the following formula (shown for the red pixel value (R) of a color camera as an example):

$$R_{\text{corrected}} = \left( \frac{R_{\text{uncorrected}}}{R_{\text{max}}} \right)^{\gamma} \times R_{\text{max}}$$

The formula uses uncorrected and corrected pixel brightnesses that are normalized by the maximum pixel brightness. The maximum pixel brightness equals 255 for 8 bit output and 4095 for 12 bit output.

The gamma correction value can be set in a range from 0 to 3.99998.

When the gamma correction value is set to 1, the output pixel brightness will not be corrected. The gamma correction value of 1 is the default value after camera reset or power up.

A gamma correction value between 0 and 1 will result in increased overall brightness, and a gamma correction value greater than 1 will result in decreased overall brightness.

In all cases, black (output pixel brightness equals 0) and white (output pixel brightness equals 255 at 8 bit output and 4095 at 12 bit output) will not be corrected.

### Setting Gamma Correction

You can use the Gamma parameter to set the gamma correction value.

Set the Gamma parameter value from within your application software by using the Basler pylon API. The following code snippet illustrates using the API to set the parameter value to 1.2 as an example:

```
// Set the Gamma value to 1.2  
camera.Gamma.SetValue(1.2);
```

You can also use the Basler pylon Viewer application to easily set the parameters.

For more information about the pylon API and the pylon Viewer, see Section 3.1 on [page 62](#).

## 7.14 Color Creation and Enhancement

This chapter provides information about how color images are created on different camera models and about the features available for adjusting the appearance of the colors.

### 7.14.1 Color Creation

The sensors in the color versions of the Basler ace USB 3.0 cameras are equipped with an additive color separation filter known as a Bayer filter. The pixel formats available on color cameras for pixel data output are related to the Bayer pattern. You therefore need a basic knowledge of the Bayer filter to understand the pixel formats. With the Bayer filter, each individual pixel is covered by a part of the filter that allows light of only one color to strike the pixel. The pattern of the Bayer filter used on the camera is as shown in [Figure 106](#) (the alignment of the Bayer filter to the pixels in the acquired images (with respect to the sensor) is shown as an example only; the figure shows the "BG" filter alignment. For an explanation, see [Section 7.14.1.1](#) on [page 278](#)). As the figure illustrates, within each square of four pixels, one pixel sees only red light, one sees only blue light, and two pixels see only green light. (This combination mimics the human eye's sensitivity to color.)

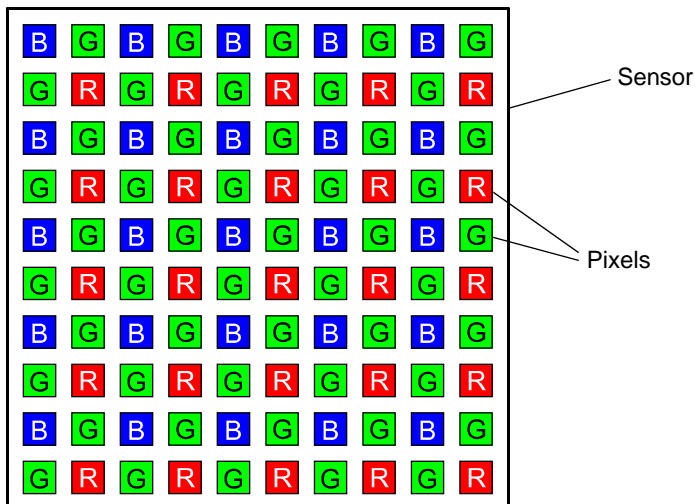

Fig. 106: Bayer Filter Pattern With "BG" Physical Alignment as an Example

### 7.14.1.1 Bayer Color Filter Alignment

All color camera models have sensors equipped with a Bayer filter. The alignment of the filter to the sensor's pixels varies with camera model (see [Table 53](#)).

Bayer BG alignment, for example, means that pixel one and pixel two of the first line in each image transmitted will be blue and green respectively. And for the second line transmitted, pixel one and pixel two will be green and red respectively. Since the pattern of a Bayer filter and its alignment on the sensor (physical alignment) are fixed, you can use this information to determine the color of all of the other pixels in the image (effective alignment). For some camera models (see below) the effective Bayer filter alignment in the image differs from the physical alignment on the sensor when Reverse X or Reverse Y or enabled. However, these differences are systematic (see Section 7.11 on [page 265](#)). The PixelColorFilter parameter indicates the effective alignment of the Bayer filter.

| Color Camera Model | Bayer Filter Alignment |    |    |
|--------------------|------------------------|----|----|
|                    | BG                     | GB | RG |
| acA640-90uc        | ●                      |    |    |
| acA640-120uc       | ●                      |    |    |
| acA640-750uc       | ●*                     |    |    |
| acA800-510uc       | ●*                     |    |    |
| acA1300-30uc       | ●                      |    |    |
| acA1300-200uc      | ●*                     |    |    |
| acA1600-20uc       | ●                      |    |    |
| acA1920-25uc       |                        | ●  |    |
| acA1920-40uc       |                        |    | ●* |
| acA1920-150uc      | ●*                     |    |    |
| acA1920-155uc      |                        |    | ●* |
| acA2000-165uc      | ●                      |    |    |
| acA2040-55uc       |                        |    | ●* |
| acA2040-90uc       |                        |    | ●  |
| acA2040-120uc      |                        |    | ●* |
| acA2440-35uc       |                        |    | ●* |
| acA2440-75uc       |                        |    | ●* |
| acA2500-14uc       |                        | ●  |    |
| acA2500-60uc       | ●*                     |    |    |
| acA3800-14uc       | ●                      |    |    |
| acA4600-10uc       | ●                      |    |    |

Table 55: Bayer Filter to Sensor Alignment

\* This Bayer filter alignment applies only when neither ReverseX nor ReverseY are enabled. For more information about the ReverseX and ReverseY features, see Section 7.11 on [page 265](#).

Because the size and position of the region of interest on color cameras with a Bayer filter must be adjusted in increments of 2 or of multiples of 2, the color filter alignment will remain constant regardless of the camera's region of interest (ROI) settings (see Section 7.6 on [page 213](#)).



### 7.14.1.2 Pixel Formats Available on Color Cameras

On color cameras, the following pixel formats are available (column for Mono format with light gray shading):

| Color Camera Model | Bayer BG 8 | Bayer GB 8 | Bayer RG 8 | Bayer BG 10 | Bayer BG 10p | Bayer BG 12 | Bayer GB 12 | Bayer RG 12 | Bayer BG 12p | Bayer GB 12p | Bayer RG 12p | RGB 8 | BGR 8 | YCbCr 422_8 | Mono 8 |
|--------------------|------------|------------|------------|-------------|--------------|-------------|-------------|-------------|--------------|--------------|--------------|-------|-------|-------------|--------|
| acA640-90uc        | •          |            |            |             |              | •           |             |             | •            |              |              | •     | •     | •           | •      |
| acA640-120uc       | •          |            |            |             |              | •           |             |             | •            |              |              | •     | •     | •           | •      |
| acA640-750uc*      | •          |            |            | •           | •            |             |             |             |              |              |              | •     | •     | •           | •      |
| acA800-510uc*      | •          |            |            | •           | •            |             |             |             |              |              |              | •     | •     | •           | •      |
| acA1300-30uc       | •          |            |            |             |              | •           |             |             | •            |              |              | •     | •     | •           | •      |
| acA1300-200*       | •          |            |            | •           | •            |             |             |             |              |              |              | •     | •     | •           | •      |
| acA1600-20uc       | •          |            |            |             |              | •           |             |             | •            |              |              | •     | •     | •           | •      |
| acA1920-25uc       |            | •          |            |             |              |             | •           |             |              | •            |              |       |       | •           | •      |
| acA1920-40uc*      |            |            | •          |             |              |             |             | •           |              |              | •            | •     | •     | •           | •      |
| acA1920-150uc*     | •          |            |            | •           | •            |             |             |             |              |              |              | •     | •     | •           | •      |
| acA1920-155uc*     |            |            | •          |             |              |             |             | •           |              |              | •            | •     | •     | •           | •      |
| acA2000-165uc      | •          |            |            |             |              | •           |             |             | •            |              |              |       |       |             |        |
| acA2040-55uc*      |            |            | •          |             |              |             |             | •           |              |              | •            | •     | •     | •           | •      |
| acA2040-90uc       | •          |            |            |             |              | •           |             |             | •            |              |              |       |       |             |        |
| acA2040-120uc*     |            |            | •          |             |              |             |             | •           |              |              | •            | •     | •     | •           | •      |
| acA2440-35uc*      |            |            | •          |             |              |             |             | •           |              |              | •            | •     | •     | •           | •      |
| acA2440-75uc*      |            |            | •          |             |              |             |             | •           |              |              | •            | •     | •     | •           | •      |
| acA2500-14uc       |            | •          |            |             |              |             | •           |             |              | •            |              |       |       | •           | •      |
| acA2500-60uc*      | •          |            |            | •           | •            |             |             |             |              |              |              | •     | •     | •           | •      |
| acA3800-14uc       | •          |            |            |             |              | •           |             |             | •            |              |              |       |       | •           | •      |
| acA4600-10uc       | •          |            |            |             |              | •           |             |             | •            |              |              |       |       | •           | •      |

Table 56: Pixel Formats Available on Color Cameras (• = format available)

\* The Bayer filter alignment given refers to the physical Bayer filter alignment with respect to the sensor's pixels. The identical alignments also apply to the images (effective alignments), provided mirror image features are not enabled.

When mirror image features are enabled, the effective alignments differ systematically from the physical alignments. The applicable pixel formats vary with the effective alignments.

For more information about effective alignments related to mirror image features, see Section 7.11 on [page 265](#).



You can find detailed information about the mono and color pixel formats in the Pixel Format Naming Convention, Version 2.0 and above. You can obtain the document from the Automated Imaging Association (AIA).

## Bayer Formats

Depending on the camera model, the cameras equipped with a Bayer pattern color filter can output color images based on the Bayer pixel formats given in [Table 56](#).

When a color camera is set for one of these Bayer pixel formats, the pixel data is not processed or interpolated in any way. For each pixel covered with a red portion of the filter, you get 8, 10 or 12 bits of red data. For each pixel covered with a green portion of the filter, you get 8, 10 or 12 bits of green data. And for each pixel covered with a blue portion of the filter, you get 8, 10 or 12 bits of blue data. (This type of pixel data is sometimes referred to as "raw" output.)

## RGB8 and BGR8 Formats

When a color camera is set for the RGB8 or BGR8 pixel format, the camera outputs 8 bit of red data, 8 bit of green data, and 8 bit of blue data for each pixel in the acquired frame. The pixel formats differ by different output sequences for the red, green, and blue data.

## YUV Formats

Most color cameras with a Bayer filter can output color images based on pixel data in YCbCr422\_8 format.

When a color camera is set for this format, each pixel value in the captured image goes through a two step conversion process as it exits the sensor and passes through the camera's electronics. This process yields Y, Cb, and Cr color information for each pixel.

In the first step of the process, a demosaicing algorithm is performed to get RGB data for each pixel. This is required because color cameras with a Bayer filter on the sensor gather only one color of light for each individual pixel.

The second step of the process is to convert the RGB information to the YCbCr color model. The conversion algorithm uses the following formulas:

$$Y = 0.299 R + 0.587 G + 0.114 B$$

$$Cb = -0.16874 R - 0.33126 G + 0.5000 B + 128$$

$$Cr = 0.5000 R - 0.41869 G - 0.08131 B + 128$$

After conversion to the YCbCr color model is complete, the pixel data is transmitted to the host computer.

## Mono Format

Most cameras equipped with a Bayer pattern color filter can output monochrome images based on pixel data in the Mono 8 format.

When a color camera is set for Mono 8, the pixel values in each captured image are first demosaiced and converted to the YCbCr color model as described above. The camera then transmits the 8 bit Y value for each pixel to the host computer. In the YCbCr color model, the Y component for each pixel represents a brightness value. This brightness value can be considered as equivalent to the value that would be sent from a pixel in a monochrome camera. So in essence, when a color camera is set for Mono 8, it outputs an 8 bit monochrome image. (This type of output is sometimes referred to as "Y Mono 8".)

## 7.14.2 Integrated IR Cut Filter

All color camera models are equipped with an IR-cut filter as standard equipment. The filter is mounted in a filter holder located in the cylindrical housing extension of the camera.

Monochrome cameras include a filter holder in the cylindrical housing extension of the camera, but the holder is not populated with an IR-cut filter.

### NOTICE

On all cameras, the lens thread length is limited.

All cameras (mono and color) are equipped with a plastic filter holder located in the cylindrical housing extension of the camera.

The location of the filter holder limits the length of the threads on any lens you use with the camera. If a lens with a very long thread length is used, the filter holder or the lens mount will be damaged or destroyed and the camera will no longer operate.

For more information about the location of the IR cut filter in the camera, see Section 1.5.2 on [page 44](#).

## 7.14.3 Color Enhancement Features



With exception of the balance white feature and the PGI feature set, the color enhancement features are not available for the following cameras: acA640-750uc, acA800-510uc, acA1300-200uc, acA1920-150uc, and acA2500-60uc.

Due to the presence of a Bayer filter in the color cameras (see Section 7.14.1 on [page 277](#)), the pixel values read out from the sensor reside in RGB color space. And for each pixel, the pixel value for only one color (red, green or blue) will be available ("raw" data).

The color enhancement features, however, require that red, green, and blue pixel values are available for each pixel.

To meet this requirement, automatic demosaicing is executed on the raw data before any color enhancement feature processes pixel data. The automatic process is also called a color transformation from RGB color space to RGB color space.

**Note:** All color enhancements described in this section are performed on pixel data in RGB color space, regardless of the pixel format chosen for pixel data output to the computer.

### 7.14.3.1 Balance White

The balance white feature allows you to perform white balancing. The feature acts on data triplets that are available for each pixel and reside in the RGB color space. So the feature lets you perform red, green, and blue adjustments for each pixel such that white objects in the camera's field of view appear white in the acquired images.



If color binning is enabled for the acA1920-25uc, white balancing is applied after color binning was performed. For more information about color binning, see Section 7.7.2 on [page 222](#).

## Setting the White Balance



This section describes how a color camera's white balance can be adjusted "manually", i.e., by setting the value of the Balance Ratio parameters for red, green, and blue.

The camera also has a Balance White Auto function that can automatically adjust the white balance. **Manual adjustment of the Balance Ratio parameters for red, green, and blue will only work, if the Balance White Auto function is disabled.**

For more information about auto functions in general, see Section 7.15 on [page 299](#).

For more information about the Balance White Auto function, see Section 7.15.7 on [page 313](#).

When you set the Light Source Preset to match your light source characteristics and/or make changes to the entries in the color transformation matrix, the camera will automatically make adjustments to the white balance settings so that they are best suited for the current settings.

For more information about using the color transformation matrix, see Section 7.14.3.5 on [page 295](#).

With the white balancing scheme used on the cameras, the red intensity, green intensity, and blue intensity can be individually adjusted. For each color, a Balance Ratio parameter is used to set the intensity of the color. If the Balance Ratio parameter for a color is set to a value of 1, the intensity of the color will be unaffected by the white balance mechanism. If the ratio is set to a value lower than 1, the intensity of the color will be reduced. If the ratio is set to a value greater than 1, the intensity of the color will be increased. The increase or decrease in intensity is proportional. For example, if the Balance Ratio for a color is set to 1.25, the intensity of that color will be increased by 25 %.

The Balance Ratio parameter value can range from 0.00 to 15.99976. But you should be aware that, if you set the balance ratio for a color to a value lower than 1, this will not only decrease the intensity of that color relative to the other two colors, but will also decrease the maximum intensity that the color can achieve. For this reason, Basler doesn't normally recommend setting a balance ratio less than 1 unless you want to correct for the strong predominance of one color.

## Particular Importance for the acA3800-14uc and acA4600-10uc

As a result of the cameras' sensor design, images output by the acA3800-14uc and acA4600-10uc cameras can display an artifact color shift. You can remove the artifact color shift by using the balance white feature.

Several conditions ("imaging conditions"; see below) govern the occurrence of the artifact color shift. Accordingly, for color shift removal, you must apply the balance white feature whenever at least one of the relevant imaging conditions changes.

Among the imaging conditions are the following:

- Optical system: exchange of lens, change of aperture, change of focus
- Illumination: change of the type of illumination, change of the arrangement of light sources, change of brightness
- Camera settings and features: The artifact color shift depends on several camera settings and features, in particular exposure time, Black Level, Digital Shift, Binning Horizontal, Binning Vertical, LUT, some image ROI-related settings (Width, Height, OffsetX, OffsetY, CenterX, CenterY).



Keep in mind from the above that color shift removal requires that you apply the balance white feature in many situations when you normally would not do so, for example after having changed the lens focus.

## Setting the Balance White Feature

### To set the Balance Ratio parameter value for color using Basler pylon:

1. Set the Balance Ratio Selector to red, green, or blue.
2. Set the Balance Ratio parameter to the desired value for the selected color.

You can set the Balance Ratio Selector and the Balance Ratio parameter value from within your application software by using the Basler pylon API. The following code snippet illustrates using the API to set the selector and the parameter value for green as an example:

```
// Select the color for white balancing and set the related BalanceRatio value
camera.BalanceRatioSelector.SetValue(BalanceRatioSelector_Green);
camera.BalanceRatio.SetValue(1.25);
```



You can also use the Basler pylon Viewer application to easily set the parameters.

For more information about the pylon API and the pylon Viewer, see Section 3.1 on [page 62](#).

### 7.14.3.2 PGI Feature Set

The PGI feature set allows to optimize the image quality of color images.

For information about the availability of the PGI feature set on a specific color camera model, see Table 42 on [page 197](#).

|   |   |
|---|---|
|  | <p>The PGI feature set can only be used when either of the following "allowed" pixel formats is enabled: RGB8, BGR8, YCbCr422_8.<br/>The PGI feature set can not be used with a Mono format, e.g. Mono 8, or a raw pixel format, e.g. Bayer BG10.</p> |
|  | <p>The PGI feature set is mainly tailored to meet the needs of human vision.</p>  |

The following image optimization features are included:

- Basler PGI demosaicing
- Noise Reduction
- Sharpness Enhancement.

Below, the features are briefly described. For more detailed information, see the White Paper "Better Image Quality with Basler PGI". The document is available on the Basler website: [www.baslerweb.com](http://www.baslerweb.com)

#### Basler PGI Demosaicing

Basler PGI demosaicing involves regions of 5x5 pixels on the sensor for color interpolation and is therefore more elaborate than the "simple" 2x2 demosaicing used otherwise by the camera. The Basler PGI 5x5 demosaicing can only operate in the context of the Basler PGI feature set.

When Basler PGI demosaicing is enabled, the following happens:

- The 5x5 color interpolation becomes effective.
- Basler PGI image quality optimization occurs automatically, bringing about most of the possible improvement.
- The Noise Reduction and Sharpness Enhancement features become available for further "manual" image quality optimization.

|   |   |
|---|---|
|  | <p>Basler PGI demosaicing can only be enabled when one of the "allowed" pixel formats (see above) is enabled.</p> |
|---|---|

## Noise Reduction

The noise reduction feature allows to reduce random color variation in an image. The feature should be applied with caution at the user's visual discretion. Noise reduction will best be used together with sharpness enhancement.

The NoiseReduction parameter value can range from 0.0 to 2.0. If NoiseReduction is set to a too high parameter value fine structure in the image can become indistinct or can disappear.

## Sharpness Enhancement

The sharpness enhancement feature allows to increase the sharpness of an image at the user's visual discretion.

The SharpnessEnhancement parameter value can range from 1.0 to 3.98438. Best results will in most cases be obtained at low parameter value settings and when used together with noise reduction.



## Setting the Basler PGI Feature Set

### To set the Basler PGI Feature Set using Basler pylon:



Make sure the balance white feature was applied before using the PGI Feature Set.

1. Select one of the "allowed" pixel formats (see above).
2. Select the Basler PGI demosaicing mode to enable 5x5 color interpolation and effect Basler PGI image quality optimization.
3. If desired, set the noise reduction feature to the visual optimum.
4. If desired, set the sharpness enhancement feature to the visual optimum.

You can set the Basler PGI Feature Set from within your application software by using the Basler pylon API. The following code snippets illustrate using the API to set the parameter values:

```
// Select 5x5 demosaicing and start Basler PGI image quality optimization
camera.DemosaicingMode.SetValue(DemosaicingMode_BaslerPGI);
DemosaicingModeEnums e = camera.(DemosaicingMode_GetValue);

// Select 2x2 demosaicing and disable Basler PGI image quality optimization
camera.DemosaicingMode.SetValue(DemosaicingMode_Simple);
DemosaicingModeEnums e = camera.(DemosaicingMode_GetValue);

// Set noise reduction, a Basler PGI feature
camera.NoiseReduction.SetValue(0.5);
double d = camera.NoiseReduction.GetValue();

// Set sharpness enhancement, a Basler PGI feature
camera.SharpnessEnhancement.SetValue(1.0);
double d = camera.SharpnessEnhancement.GetValue();
```

You can also use the Basler pylon Viewer application to easily set the parameters.

For more information about the pylon API and the pylon Viewer, see Section 3.1 on [page 62](#).

### 7.14.3.3 Light Source Presets

According to its specific spectral characteristics ("color temperature") the light used for image acquisition can cause color shifts in the image. You can correct for the specific color shifts due to a specific light source by selecting the related light source preset.

You can correct for the following kinds of light sources:

- Off - No light source preset is selected and no gamma correction will automatically be applied (gamma correction value = 1). We recommend setting the gamma parameter value to 0.41667. This setting will adjust the pixel values for display on an sRGB monitor without, however, taking account of a specific light source.
- Daylight 5000 K - This setting will make appropriate corrections for images captured with daylight lighting that has a color temperature of about 5000 K. When you select this setting, the camera will also adjust the white balance settings and the color adjustment settings so that they are appropriate for a daylight light source with a color temperature of about 5000 K. This correction will be set as the default after camera reset or power up.
- Daylight 6500 K - This setting will make appropriate corrections for images captured with daylight lighting that has a color temperature of about 6500 K. When you select this setting, the camera will also adjust the white balance settings and the color adjustment settings so that they are appropriate for a daylight light source with a color temperature of about 6500 K.
- Tungsten 2800 K - This setting will make appropriate corrections for images captured with tungsten lighting that has a color temperature of about 2500 K to 3000 K. When you select this setting, the camera will also adjust the white balance settings and the color adjustment settings so that they are appropriate for a tungsten incandescent light source.



For the light source presets to work properly, the white balance must be correct. See Section 7.14.3.1 on [page 283](#) for more information about the white balance, Section 7.14.3.4 on [page 290](#) for more information about color adjustment, and Section 7.14.3.6 on [page 297](#) for an overall procedure for setting the color enhancement features.



When using a light source preset for a color camera, a gamma correction value of approximately 0.4 will automatically be applied, corresponding to an sRGB gamma correction value. Under these circumstances, we recommend not to explicitly set a gamma correction value. If you do nonetheless you will alter the effect of the selected light source preset. If you select "Off" as the light source preset no gamma correction value will automatically be applied. For more information about the gamma correction feature, see Section 7.13 on [page 275](#).

The correction for a specific light source uses a color transformation matrix that is automatically populated by coefficients ("color transformation values") suitable for the set light source. The color

transformation values modify color-specific gain for red, green, and blue. The identity matrix is used when "Off" is selected as the light source preset.

## Setting the Light Source Presets

You can use the Light Source Preset parameter value to set the correction for a specific light source or chose no correction. You can set the parameter value from within your application software by using the Basler pylon API. The following code snippet illustrates using the API to set the selector and the parameter value:

```
// Set the LightSourcePreset parameter value to "Off" (no correction)
camera.LightSourcePreset.SetValue(LightSourcePreset_Off);

//Set the LightSourcePreset parameter value to "Daylight5000K"
camera.LightSourcePreset.SetValue(LightSourcePreset_Daylight5000K);

// Set the LightSourcePreset parameter value to "Daylight6500K"
camera.LightSourcePreset.SetValue(LightSourcePreset_Daylight6500K);

// Set the LightSourcePreset parameter value to "Tungsten2800K"
camera.LightSourcePreset.SetValue(LightSourcePreset_Tungsten2800K);
```

### 7.14.3.4 Color Adjustment (All Color Cameras Except acA2000-165 and acA2040-90)

The camera's color adjustment feature lets you adjust hue and saturation for the primary and secondary colors in the RGB color space. Each adjustment affects those colors in the image where the adjusted primary or secondary color predominates. For example, the adjustment of red affects the colors in the image with a predominant red component.



Although color adjustment can be used without also using a light source preset, we nonetheless strongly recommend to use both in combination if a suitable light source preset is available. This will allow you to make full use of the camera's color enhancement capabilities.

If no suitable light source preset is available you can perform the desired color corrections using the color transformation matrix.

See Section 7.14.3.5 on [page 295](#) for more information about the color transformation matrix.



If color binning is enabled for the acA1920-25uc or acA2500-14uc, color adjustment will be applied after color binning was performed. For more information about color binning, see Section 7.8.2 on [page 253](#).

## The RGB Color Space

The RGB color space includes light with the primary colors red, green, and blue and all of their combinations. When red, green, and blue light are combined and when the intensities of R, G, and B are allowed to vary independently between 0% and 100%, all colors within the RGB color space can be formed. Combining colored light is referred to as additive mixing.

When two primary colors are mixed at equal intensities, the secondary colors will result. The mixing of red and green light produces yellow light (Y), the mixing of green and blue light produces cyan light (C), and the mixing of blue and red light produces magenta light (M).

When the three primary colors are mixed at maximum intensities, white will result. In the absence of light, black will result.

The color space can be represented as a color cube (see Figure 107 on [page 292](#)) where the primary colors R, G, B, the secondary colors C, M, Y, and black and white define the corners. All shades of gray are represented by the line connecting the black and the white corner (see Figure 107 on [page 292](#))

For ease of imagination, the color cube can be projected onto a plane (as shown in Figure 107) such that a color hexagon is formed. The primary and secondary colors define the corners of the color hexagon in an alternating fashion. The edges of the color hexagon represent the colors resulting from mixing the primary and secondary colors. The center of the color hexagon represents all shades of gray including black and white.

The representation of any arbitrary color of the RGB color space will lie within the color hexagon. The color will be characterized by its hue and saturation:

- Hue specifies the kind of coloration, for example, whether the color is red, yellow, orange etc.
- Saturation expresses the colorfulness of a color. At maximum saturation, no shade of gray is present. At minimum saturation, no "color" but only some shade of gray (including black and white) is present.

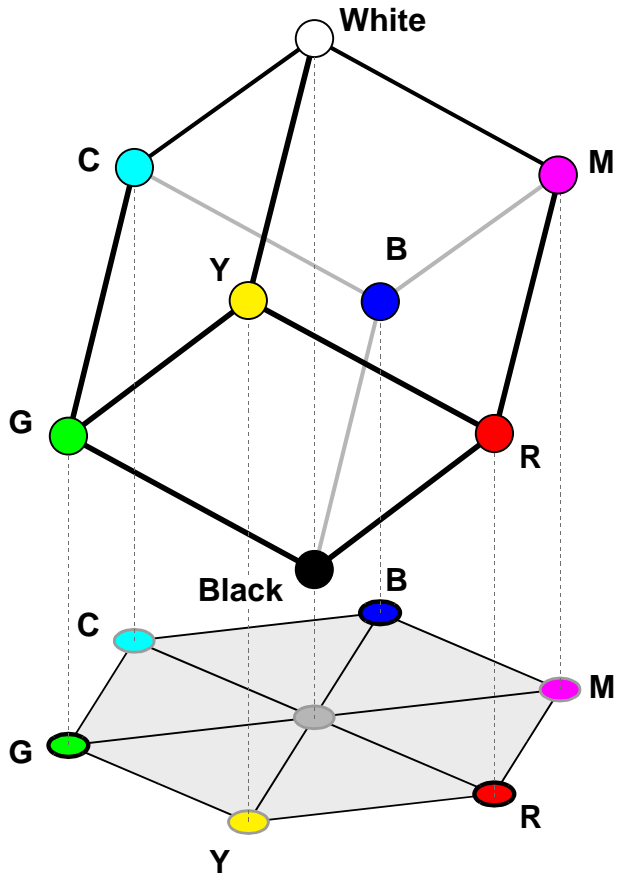

Fig. 107: RGB Color Cube With YCM Secondary Colors, Black, and White, Projected On a Plane

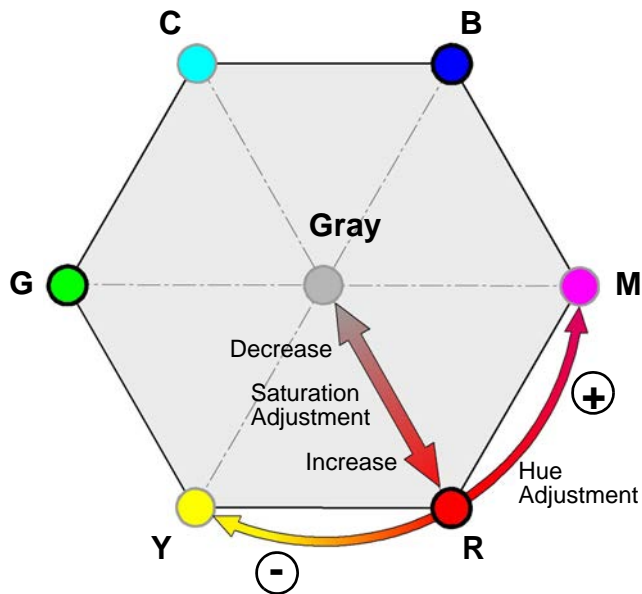

Fig. 108: Hue and Saturation Adjustment In the Color Hexagon. Adjustments Are Indicated for Red as an Example

## Hue and Saturation Adjustment

The color adjustment feature lets you adjust hue and saturation for the primary and the secondary colors. Each adjustment affects those areas in the image where the adjusted color predominates. For example, the adjustment of red affects the colors in the image with a predominantly red component.

Keep in mind that when you adjust a color, the nearest neighboring colors in the color hexagon will also be affected to some degree. For example, when you adjust red, yellow and magenta will also be affected.

- Hue:** In the color hexagon, the adjustment of hue can be considered as a rotation between hues. Primary colors can be rotated towards, and as far as, their neighboring secondary colors. And secondary colors can be rotated towards, and as far as, their neighboring primary colors.

For example, when red is rotated in negative direction towards yellow, then, for example, purple in the image can be changed to red and red in the image can be changed to orange.

Red can be rotated as far as yellow, where red will be completely transformed into yellow.

When red is rotated in a positive direction towards magenta, then, for example, orange in the image can be changed to red and red in the image can be changed to purple.

Red can be rotated as far as magenta, where red will be completely transformed into magenta.

- Saturation:** Adjusting saturation changes the colorfulness (intensity) of a color. The color adjustment feature lets you adjust saturation for the primary and secondary colors.

For example, if saturation for red is increased, the colorfulness of red colors in the image will increase. If red is set to minimum saturation, red will be replaced by gray for "red" colors in the image.

## Color Adjustment Parameters

You can use the Color Adjustment Selector parameter to select a color to adjust. The colors you can select are red, yellow, green, cyan, blue, and magenta.

You can use the Color Adjustment Hue parameter to set the hue for the selected color as a floating point value in a range from -4.0 to +3.96875. Hue is not changed when the parameter value is set to 0. The default value after camera reset or power up is close to 0.

You can use the Color Adjustment Saturation parameter to set the saturation for the selected color as a floating point value in a range from 0.0 to +1.99219. Saturation is not changed when the parameter value is set to 1. The default value after camera reset or power up is close to 1.

## Enabling and Setting Color Adjustment

You can set the Color Adjustment Hue and Color Adjustment Saturation parameter values from within your application software by using the Basler pylon API. The following code snippets illustrate using the API to set the parameter values:

```
// Select red as the color to adjust
camera.ColorAdjustmentSelector.SetValue(ColorAdjustmentSelector_Red);
// Set the red hue parameter value
camera.ColorAdjustmentHue.SetValue(-1.125);
// Set the red saturation parameter value
camera.ColorAdjustmentSaturation.SetValue(1.375);

// Select cyan as the color to adjust
camera.ColorAdjustmentSelector.SetValue(ColorAdjustmentSelector_Cyan);
// Set the cyan hue parameter value
camera.ColorAdjustmentHue.SetValue(-1.6875);
// Set the cyan saturation parameter value
camera.ColorAdjustmentSaturation.SetValue(0.85);
```

You can also use the Basler pylon Viewer application to easily set the parameters.

For more information about the pylon API and the pylon Viewer, see Section 3.1 on [page 62](#).

## 7.14.3.5 Color Transformation

### Introduction

The main objective for using a color transformation matrix is to make corrections to the color information delivered by the camera's sensor. The correction can account for the kind of light source used during image acquisition and compensate for imperfections in the sensor's color generation process.



Color correction by means of the color transformation matrix is intended for use by only someone who is thoroughly familiar with matrix color transformations. **It is nearly impossible to enter correct values in the transformation matrix by trial and error.**



For color transformation to work properly, the white balance must be correct. See Section 7.14.3.1 on [page 283](#) for more information about the white balance and see Section 7.14.3.6 on [page 297](#) for an overall procedure for setting the color enhancement features.



Although the color transformation matrix can be used without using a light source preset, we nonetheless strongly recommend to also use the suitable light source preset if available, to make full use of the camera's color enhancement capabilities.

If no suitable light source preset is available you can perform the desired color corrections using the color transformation matrix.



If color binning is enabled for the acA1920-25uc or acA2500-14uc, the color transformation matrix will be applied after color binning was performed. For more information about color binning, see Section 7.8.2 on [page 253](#).



## The Color Transformation Matrix

The color transformation feature processes red, green, and blue pixel data made available for each pixel (Section 7.14.3 on [page 283](#)) and uses a transformation matrix to deliver modified red, green, and blue pixel data for each pixel.

The RGB to RGB color matrix transformation for each pixel is performed by premultiplying a 3 x 1 matrix containing R, G, and B pixel values, by a 3 x 3 matrix containing color transformation values that modify color-specific gain.

$$\begin{bmatrix} \text{Gain00} & \text{Gain01} & \text{Gain02} \\ \text{Gain10} & \text{Gain11} & \text{Gain12} \\ \text{Gain20} & \text{Gain21} & \text{Gain22} \end{bmatrix} \begin{bmatrix} R \\ G \\ B \end{bmatrix} = \begin{bmatrix} R' \\ G' \\ B' \end{bmatrix}$$



When setting the transformation values, you will find that the transformation matrix is already populated with color transformation values. They will correspond to unit vectors, be related to previously set light source presets or result from a previous application of the color transformation feature.

You can set each color transformation value according to your choice. Each GainXY position can be populated with a floating point value ranging from -8.0 to +7.96875 by using the Color Transformation Value Selector to select one of the GainXY positions in the matrix and using the Color Transformation Value parameter to enter a value for that position and thereby replace the previous value.

A reference article that explains the basics of color matrix transformation for image data can be found at:

<http://www.its.bldrdoc.gov/publications/2437.aspx>

## Setting Color Transformation Matrix Values

You can set the Color Transformation Value Selector and Color Transformation Values from within your application software by using the Basler pylon API. The following code snippet illustrates using the API to set the values in the matrix. Note that the values in this example are just randomly selected numbers and do not represent values that you should actually use.

```
// Select a position in the matrix
camera.ColorTransformationValueSelector.SetValue(ColorTransformationValueSelector_Gain00);
// Set the value for the selected position as a floating point value
camera.ColorTransformationValue.SetValue(1.5625);
// Select a position in the matrix
camera.ColorTransformationValueSelector.SetValue(ColorTransformationValueSelector_Gain01);
// Set the value for the selected position as a floating point value
camera.ColorTransformationValue.SetValue(-0.4375);
```

You can also use the Basler pylon Viewer application to easily set the parameters.

For more information about the pylon API and the pylon Viewer, see Section 3.1 on [page 62](#).

### 7.14.3.6 A Procedure for Setting the Color Enhancements

When setting the color enhancements on the camera, we recommend using the procedure outlined below. Since it makes changing camera parameters quick and easy, we also recommend using the Basler pylon Viewer software when you are making adjustments.

**Note:** The procedure aims at producing a color reproduction on a monitor that is optimized for human vision. The optimum for machine vision may require different color enhancement settings.

#### To set the color enhancements:

1. Arrange your camera so that it is viewing a scene similar to what it will view during actual operation. Make sure that the lighting for the scene is as close as possible to the actual lighting you will be using during normal operation. (Using lighting that represents your normal operating conditions is extremely important.)

We recommend placing a standard color chart within your camera's field of view when you are adjusting the color enhancements. This will make it much easier to know when the colors are properly adjusted. One widely used chart is the ColorChecker® chart (also known as the Macbeth chart).

2. Make sure the settings for gain, black level, digital shift, auto target brightness are at their minimums.
3. Set the Light Source Preset parameter to the value that is most appropriate for your lighting. For example, If you use tungsten incandescent light select the Tungsten2800K light source preset.
4. Begin capturing images and check the basic image appearance. Set the exposure time, black level, and gain so that you are acquiring good quality images. It is important to make sure that the images are not over exposed. Over exposure can have a significant negative effect on the fidelity of the color in the acquired images. Generally, the settings for black level, digital shift, auto target brightness, and particularly so for gain, should be as low as possible.
5. Adjust the white balance. Make sure a white or light gray object is imaged while white balance is carried out. An easy way to set the white balance is to use the "once" function on the camera's balance white auto feature.
6. Set the gamma value if necessary. When gamma is set correctly, there should be a smooth transition from the lightest to the darkest gray scale targets on your color chart or on a gray scale.
  - If the camera is set to light source preset parameter value Daylight5000K (default), Daylight6500K or Tungsten2800K, the camera will provide gamma encoded images (according to sRGB) that should be displayed on the monitor with great color fidelity. Accordingly, there should be little need to change the default setting of one for the gamma parameter.
  - If the camera is set to the light source preset parameter value "Off" the camera will provide images without gamma encoding. In this case we recommend setting the gamma parameter value to 0.41667.
7. Examine the colors and see if they are satisfactory at this point. If not, chose a different setting for the Light Source Preset parameter. Try each mode and determine which one gives you the best color results.

8. The color fidelity should now be quite good. If you want to make additional changes, adjust the hue and saturation by using the color adjustment feature. Keep in mind that when you adjust a color, the colors on each side of it in the color hexagon will also be affected to some degree. For example, when you adjust red, yellow and magenta will also be affected.

When you are making hue and saturation adjustments, it is a good idea to start by concentrating on one line in the color chart. Once you have the colors in a line properly adjusted, you can move on to each of the other lines in turn.



When you first start working with the color enhancement tools, it is easy to badly misadjust the color adjustment settings and not be able to bring them back into proper adjustment. You can reset the parameter settings by camera reset or power up.



Certain conditions outside the camera, such as the lighting, the camera lens, filter or the monitor settings are relevant to the reproduction of color in the image. If you change any of these conditions you will have to repeat the above procedure to preserve optimum color reproduction.

9. If available for your camera model, reduce noise in the image and enhance its sharpness by enabling the PGI Feature Set. If you desire a stronger effect, carry out further adjustments by using the related parameters.

For Information about the PGI feature set, see Section 7.14.3.2 on [page 286](#).

## 7.15 Auto Functions

### 7.15.1 Common Characteristics

Auto functions control image properties and are generally the "automatic" counterparts of certain features such as the gain feature or the white balance feature, which normally require "manually" setting the related parameter values. Auto functions are particularly useful when an image property must be adjusted quickly to achieve a specific target value and when a specific target value must be kept constant in a series of images.

An Auto Function Region of Interest (Auto Function ROI) lets you designate a specific part of the image as the base for adjusting an image property. Each auto function uses the pixel data from an Auto Function ROI for automatically adjusting a parameter value and, accordingly, for controlling the related image property. Some auto functions use their own individual Auto Function ROI and some auto functions share a single Auto Function ROI.

An auto function automatically adjusts a parameter value until the related image property reaches a target value. Note that the manual setting of the parameter value is not preserved. For example, when the Gain Auto function adjusts the gain parameter value, the manually set gain parameter value is not preserved.

For some auto functions, the target value is fixed. For other auto functions, the target value can be set, as can the limits between which the related parameter value will be automatically adjusted. For example, the gain auto function lets you set an average gray value for the image as a target value and also set a lower and an upper limit for the gain parameter value.

Generally, the different auto functions can operate at the same time. For more information, see the following sections describing the individual auto functions.



A target value for an image property can only be reached, if it is in accord with all pertinent camera settings and with the general circumstances used for capturing images. Otherwise, the target value will only be approached.

For example, with a short exposure time, insufficient illumination, and a low setting for the upper limit of the gain parameter value, the Gain Auto function may not be able to achieve the current target average gray value setting for the image.



You can use an auto function when binning is enabled (monochrome cameras and the acA1920-25uc only). An auto function uses the binned pixel data and controls the image property of the binned image.

For more information about binning, see Section 7.8 on [page 250](#).

## 7.15.2 Auto Function Operating Modes

The following auto function modes of operation are available:

- All auto functions provide the "once" mode of operation. When the "once" mode of operation is selected, the parameter values are automatically adjusted until the related image property reaches the target value. After the automatic parameter value adjustment is complete, the auto function will automatically be set to "off" and the new parameter value will be applied to the following images.

The parameter value can be changed by using the "once" mode of operation again, by using the "continuous" mode of operation, or by manual adjustment.



If an auto function is set to the "once" operation mode and if the circumstances will not allow reaching a target value for an image property, the auto function will try to reach the target value for a maximum of 30 images and will then be set to "off".

- Some auto functions also provide a "continuous" mode of operation where the parameter value is adjusted repeatedly while images are acquired.

Depending on the current frame rate, the automatic adjustments will usually be carried out for every or every other image.

The repeated automatic adjustment will proceed until the "once" mode of operation is used or until the auto function is set to "off", in which case the parameter value resulting from the latest automatic adjustment will operate, unless the parameter is manually adjusted.

- When an auto function is set to "off", the parameter value resulting from the latest automatic adjustment will operate, unless the parameter is manually adjusted.



You can enable auto functions and change their settings while the camera is capturing images ("on the fly").



If you have set an auto function to "once" or "continuous" operation mode while the camera was continuously capturing images, the auto function will become effective with a short delay and the first few images may not be affected by the auto function.

### 7.15.3 Auto Function ROIs

Each auto function uses the pixel data from an Auto Function ROI for automatically adjusting a parameter value, and accordingly, for controlling the related image property. Some auto functions always share an Auto Function ROI and some auto functions can use their own individual Auto Function ROIs. Within these limitations, auto functions can be assigned to Auto Function ROIs as desired.

Each Auto Function ROI has its own specific set of parameter settings, and the parameter settings for the Auto Function ROIs are not tied to the settings for the ROI that is used to define the size of captured images (Image ROI). For each Auto Function ROI, you can specify a portion of the sensor array and only the pixel data from the specified portion will be used for auto function control. Note that an Auto Function ROI can be positioned anywhere on the sensor array.

An Auto Function ROI is referenced to the top left corner of the sensor array. The top left corner of the sensor array is designated as column 0 and row 0 as shown in [Figure 109](#).

The location and size of an Auto Function ROI is defined by declaring an X offset (coordinate), a width, a Y offset (coordinate), and a height. For example, suppose that you specify the X offset as 14, the width as 5, the Y offset as 7, and the height as 6. The area of the array that is bounded by these settings is shown in [Figure 109](#).

Only the pixel data from the area of overlap between the Auto Function ROI defined by your settings and the Image ROI will be used by the related auto function.

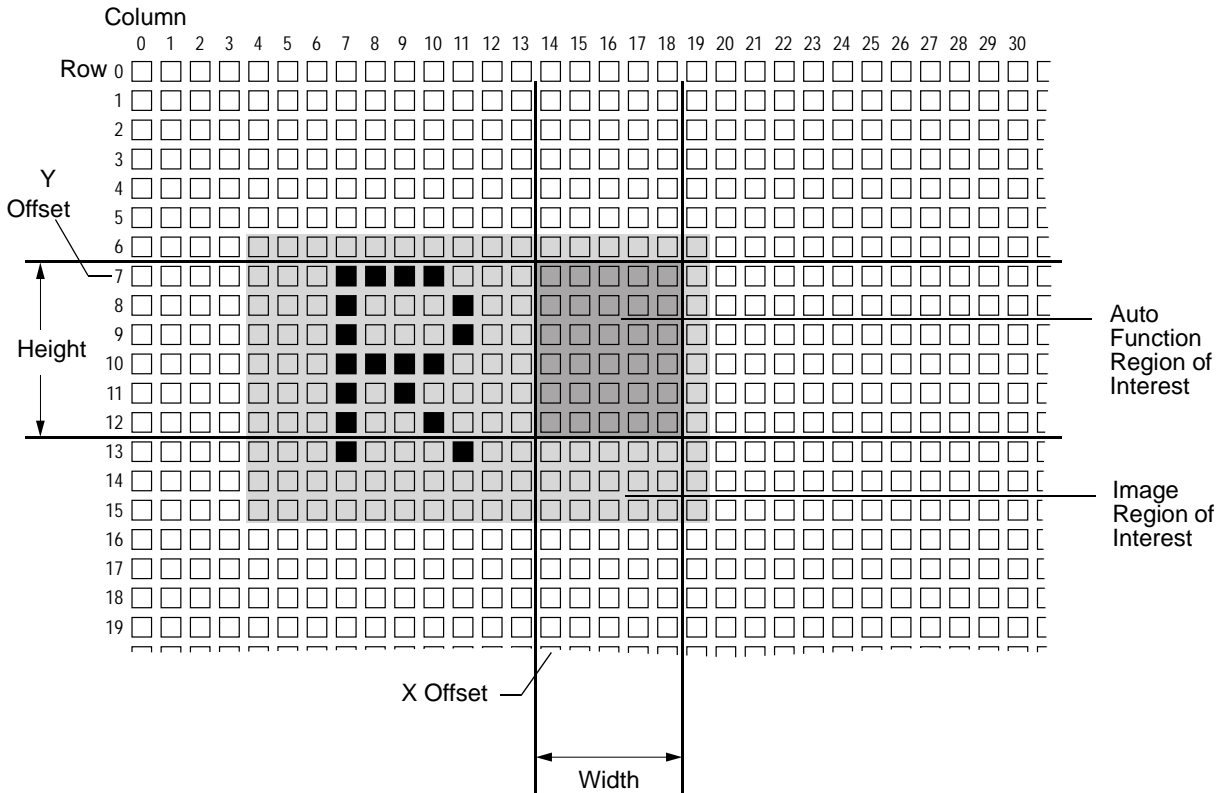

Fig. 109: Auto Function Region of Interest and Image Region of Interest

### 7.15.3.1 Assignment of an Auto Function to an Auto Function ROI

By default, the Gain Auto and the Exposure Auto auto functions are assigned to Auto Function ROI 1 and the Balance White Auto auto function is assigned to Auto Function ROI 2. The assignments can, however, be set as desired. For example, the Balance White Auto auto function can be assigned to Auto Function ROI 1 or all auto functions can be assigned to the same Auto Function ROI.



We strongly recommend not to assign an auto function to more than one Auto Function ROI although multiple assignments can be made

One limitation must be borne in mind: For the purpose of making assignments, the Gain Auto and the Exposure Auto auto functions are always considered as a single "brightness" auto function and therefore the assignment is always identical for both auto functions. For example, if you assign the "brightness" auto function to Auto Function ROI 2 the Gain Auto and the Exposure Auto auto functions should both assigned to Auto Function ROI 2. This does not imply, however, that the Gain Auto and the Exposure Auto auto functions must always be used at the same time.

You can assign auto functions to Auto Function ROIs from within your application software by using the pylon API.

As an example, the following code snippet illustrates using the API to assign the Gain Auto and Exposure Auto auto function - considered as a single "brightness" auto function - and the Balance White auto function to Auto Function ROI 1.

The snippet also illustrates disabling the unused Auto Function ROI 2 to avoid assigning any auto function to more than one Auto Function ROI.

```
// Select Auto Function ROI 1
// Assign auto functions to the selected Auto Function ROI
camera.AutoFunctionROISelector.SetValue(AutoFunctionROISelector_ROI1);
camera.AutoFunctionROIUseBrightness.SetValue(true);
camera.AutoFunctionROIUseWhiteBalance.SetValue(true);

// Select the unused Auto Function ROI 2
// Disable the unused Auto Function ROI
camera.AutoFunctionROISelector.SetValue(AutoFunctionROISelector_ROI2);
camera.AutoFunctionROIUseBrightness.SetValue(false);
camera.AutoFunctionROIUseWhiteBalance.SetValue(false);
```

You can also use the Basler pylon Viewer application to easily set the parameters.

### 7.15.3.2 Positioning of an Auto Function ROI Relative to the Image ROI

The size and position of an Auto Function ROI can be, but need not be, identical to the size and position of the Image ROI. Note that the overlap between Auto Function ROI and Image ROI determines whether and to what extent the auto function will control the related image property. Only the pixel data from the areas of overlap will be used by the auto function to control the image property of the entire image.

Different degrees of overlap are illustrated in [Figure 110](#). The hatched areas in the figure indicate areas of overlap.

- If the Auto Function ROI is completely included in the Image ROI (see (a) in [Figure 110](#)), the pixel data from the Auto Function ROI will be used to control the image property.
- If the Image ROI is completely included in the Auto Function ROI (see (b) in [Figure 110](#)), only the pixel data from the Image ROI will be used to control the image property.
- If the Image ROI only partially overlaps the Auto Function ROI (see (c) in [Figure 110](#)), only the pixel data from the area of partial overlap will be used to control the image property.
- If the Auto Function ROI does not overlap the Image ROI (see (d) in [Figure 110](#)), the Auto Function will **not** or only to a **limited** degree control the image property. For details, see the sections below, describing the individual auto functions.



We strongly recommend completely including the Auto Function ROI within the Image ROI, or, depending on your needs, choosing identical positions and sizes for Auto Function ROI and Image ROI.



You can use auto functions when also using the Reverse X feature. For information about the behavior and roles of Auto Function ROI and Image ROI when also using the Reverse X feature, see the "Reverse X" section.



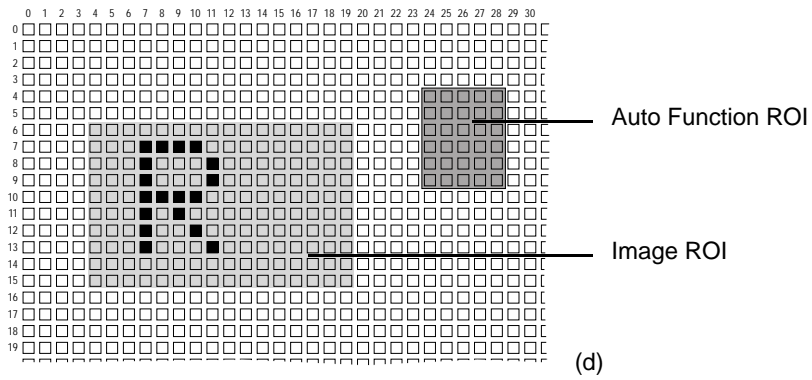
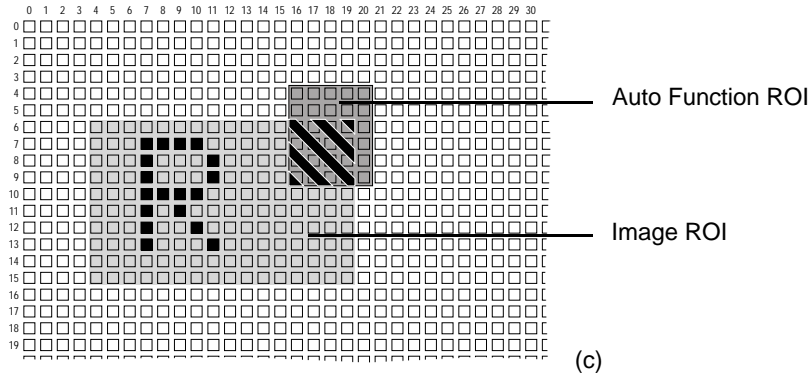
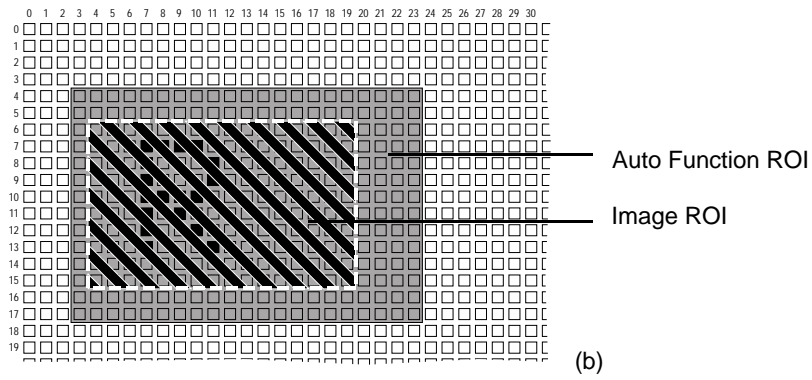
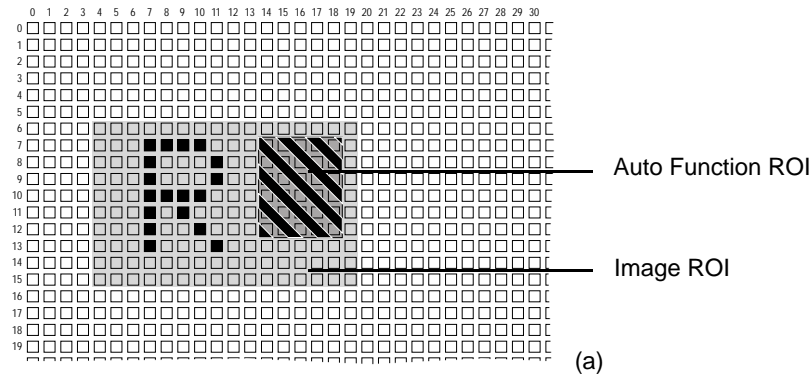

Fig. 110: Various Degrees of Overlap Between the Auto Function ROI and the Image ROI

### 7.15.3.3 Setting an Auto Function ROI

Setting an Auto Function ROI is a two-step process: You must first select the Auto Function ROI related to the auto function that you want to use and then set the size and the position of the Auto Function ROI.

By default, an Auto Function ROI is set to the full resolution of the camera's sensor. You can change the size and the position of an Auto Function ROI by changing the value of the Auto Function ROI's X Offset, Y Offset, Width, and Height parameters.

- The value of the X Offset parameter determines the starting column for the Auto Function ROI.
- The value of the Y Offset parameter determines the starting row for the Auto Function ROI.
- The value of the Width parameter determines the width of the Auto Function ROI.
- The value of the Height parameter determines the height of the Auto Function ROI.

When you are setting an Auto Function ROI, you must follow these guidelines:

- The sum of the Offset X setting plus the Width setting must not exceed the width of the camera's sensor. For example, on the acA1920-25um, the sum of the Offset X setting plus the Width setting must not exceed 1920.
- The sum of the Offset Y setting plus the Height setting must not exceed the height of the camera's sensor. For example, on the acA1920-25um, the sum of the Offset Y setting plus the Height setting must not exceed 1080.

The X Offset, Y Offset, Width, and Height parameters can be set in increments of 1.



On color cameras, we strongly recommend setting the Offset X, Offset Y, Width, and Height parameters for an Auto Function ROI in increments of 2 to make the Auto Function ROI match the color filter pattern of the sensor. For example, you should set the X Offset parameter to 0, 2, 4, 6, 8, etc.



Normally, the Offset X, Offset Y, Width, and Height parameter settings for an Auto Function ROI refer to the physical columns and lines in the sensor. But if binning is enabled (monochrome cameras only), these parameters are set in terms of "virtual" columns and lines, i.e. the settings for an Auto Function ROI will refer to the binned lines and columns in the sensor and not to the physical lines in the sensor as they normally would.

For more information about the concept of a "virtual sensor", see Section 7.8.4 on [page 256](#).

You can select an Auto Function ROI and set the Offset X, Offset X, Width, and Height parameter values for the Auto Function ROI from within your application software by using the Basler pylon API. The following code snippets illustrate using the API to select an Auto Function ROI and to get the maximum allowed settings for the Width and Height parameters. The code snippets also

illustrate setting the Offset X, Offset Y, Width, and Height parameter values. As an example, Auto Function ROI 1 is selected:

```
// Select the appropriate auto function ROI for gain auto and exposure
// auto control. Currently, auto function ROI1 is predefined to gather
// the pixel data needed for gain auto and exposure auto control.
// Set the position and size of the auto function ROI
// Note: The code uses ROI instead of the former AOI. For example, ROI1
// was previously named AOI1 in the code.
camera.AutoFunctionROISelector.SetValue(AutoFunctionROISelector_ROI1 );
camera.AutoFunctionROIOffsetX.SetValue( 0 );
camera.AutoFunctionROIOffsetY.SetValue( 0 );
camera.AutoFunctionROIWidth.SetValue(1294); camera.AutoFunctionROI-
Width.GetMax();
camera.AutoFunctionROIHeight.SetValue(964);
camera.AutoFunctionROIHeight.GetMax();
```

You can also use the Basler pylon Viewer application to easily set the parameters.

For more information about the pylon API and the pylon Viewer, see Section 3.1 on [page 62](#).

## 7.15.4 Gain Auto

Gain Auto is the "automatic" counterpart to manually setting the gain All parameter. When the gain auto function is operational, the camera will automatically adjust the gain All parameter value within set limits until a target average gray value for the pixel data from the related Auto Function ROI is reached.

The gain auto function can be operated in the "once" and continuous" modes of operation.

If the related Auto Function ROI does not overlap the Image ROI (see the "Auto Function ROI" section) the pixel data from the Auto Function ROI will not be used to control the gain. Instead, the current manual setting for the gain All parameter value will control the gain.

Either Auto Function ROI can be selected to work with the balance white auto function.

The gain auto function and the exposure auto function can be used at the same time. In this case, however, you must also set the auto function profile feature.

For more information about setting the gain "manually", see Section 7.2 on [page 198](#).

For more information about the auto function profile feature, see Section 7.15.6 on [page 312](#).

The limits within which the camera will adjust the gain All parameter are defined by the Auto Gain Upper Limit and the Auto Gain Lower Limit parameters. The minimum and maximum allowed settings for the Auto Gain Upper Limit and Auto Gain Lower Limit parameters depend on the current pixel data format, on the current settings for binning, and on whether or not the parameter limits for manually setting the gain feature are disabled.

The Auto Target Brightness parameter defines the target average gray value that the gain auto function will attempt to achieve when it is automatically adjusting the gain All value. The target average gray value can range from 0 (black) to 255 (white) when the camera is set for an 8 bit pixel format or from 0 (black) to 4095 (white) when the camera is set for a 12 bit pixel format.

### To set the gain auto function using Basler pylon:

1. Select the Auto Function ROI, for example ROI1.
2. Set the value of the Offset X, Offset Y, Width, and Height parameters for the ROI.
3. Set the Gain Selector to All.
4. Set the value of the Auto Gain Lower Limit and Auto Gain Upper Limit parameters.
5. Set the value of the Auto Target Brightness parameter.
6. Set the value of the Gain Auto parameter for the "once" or the "continuous" mode of operation.

You can set the gain auto function from within your application software by using the pylon API. The following code snippets illustrate using the API to set the gain auto function:

```
// Select auto function ROI 1 (as an example) to allow
// Gain Auto to control image brightness.
camera.AutoFunctionROISelector.SetValue
(AutoFunctionROISelector_ROI1);
```

```
camera.AutoFunctionROIUseBrightness.SetValue(true);

// Set the position and size of the auto function ROI
camera.AutoFunctionROIOffsetX.SetValue(0);
camera.AutoFunctionROIOffsetY.SetValue(0);
camera.AutoFunctionROIWidth.SetValue(1294);
camera.AutoFunctionROIHeight.SetValue(964);

// Set the maximum possible size of the selected auto function ROI
camera.AutoFunctionROIOffsetX.SetValue(0);
camera.AutoFunctionROIOffsetY.SetValue(0);
camera.AutoFunctionROIWidth.SetValue( camera.AutoFunctionROI-
Width.GetMax() );
camera.AutoFunctionROIHeight.SetValue( camera.AutoFunctionROI-
Height.GetMax() );

// Select gain all and set the upper and lower gain limits for
// the gain auto function
camera.GainSelector.SetValue(GainSelector_All);
camera.AutoGainLowerLimit.SetValue(0.0);
camera.AutoGainUpperLimit.SetValue(19.745);

// Set the lowest possible lower limit and the highest possible
// upper limit for the gain auto function
camera.AutoGainLowerLimit.SetValue( camera.AutoGainLowerLimit.Get-
Min());
camera.AutoGainUpperLimit.SetValue(
camera.AutoGainUpperLimit.GetMax());

// Set the target gray value for the selected auto function
// The parameter value range refers to the theoretically maximum
// available range of gray values for the set pixel format.
// For example, if an 8 bit pixel format is set, a parameter value
// of 0.50196 will correspond to a gray value of 128.
camera.AutoTargetBrightness.SetValue(0.50196);

// Set the mode of operation for the gain auto function
camera.GainAuto.SetValue(GainAuto_Once);
```

You can also use the Basler pylon Viewer application to easily set the parameters.

For more information about the pylon API and the pylon Viewer, see Section 3.1 on [page 62](#).

For general information about auto functions, see Section 7.15 on [page 299](#).

For information about Auto Function ROIs and how to set them, see Section 7.15.3 on [page 301](#).

## 7.15.5 Exposure Auto



The exposure auto function will not work, if the camera's exposure mode is set to trigger width. For more information about the trigger width exposure mode, see Section 6.4.3.2 on [page 136](#).

Exposure Auto is the "automatic" counterpart to manually setting the Exposure Time parameter. The exposure auto function automatically adjusts the Exposure Time parameter value within set limits until a target average gray value for the pixel data from the selected Auto Function ROI is reached.

Either Auto Function ROI can be selected to work with the exposure auto function.

The exposure auto function can be operated in the "once" and "continuous" modes of operation.

If the Auto Function ROI does not overlap the Image ROI (see the "Auto Function ROI" section) the pixel data from the Auto Function ROI will not be used to control the exposure time. Instead, the current manual setting of the Exposure Time parameter value will control the exposure time.

The exposure auto function and the gain auto function can be used at the same time. In this case, however, you must also set the auto function profile feature.

When trigger width exposure mode is selected, the exposure auto function is not available.

For more information about setting the exposure time "manually", see Section 6.9 on [page 180](#).

For more information about the trigger width exposure mode, see Section 6.4.3.2 on [page 136](#).

For more information about the auto function profile feature, see Section 7.15.6 on [page 312](#).

The limits within which the camera will adjust the Exposure Time parameter are defined by the Auto Exposure Time Upper Limit and the Auto Exposure Time Lower Limit parameters. The current minimum and the maximum allowed settings for the Auto Exposure Time Upper Limit parameter and the Auto Exposure Time Lower Limit parameters depend on the minimum allowed and maximum possible exposure time for your camera model.

The Auto Target Brightness parameter defines the target average gray value that the exposure auto function will attempt to achieve when it is automatically adjusting the Exposure Time value. The target average gray value may range from 0 (black) to 255 (white) when the camera is set for an 8 bit pixel format or from 0 (black) to 4095 (white) when the camera is set for a 12 bit pixel format.



If the Auto Exposure Time Upper Limit parameter is set to a sufficiently high value the camera's frame rate can be decreased.

#### To set the exposure auto function using Basler pylon:

1. Select the Auto Function ROI, for example ROI 1.
2. Set the value of the Offset X, Offset Y, Width, and Height parameters for the ROI.
3. Set the value of the Auto Exposure Time Lower Limit and Auto Exposure Time Upper Limit parameters.
4. Set the value of the Auto Target Brightness parameter.
5. Set the value of the Exposure Auto parameter for the "once" or the "continuous" mode of operation.

You can set the exposure auto function from within your application software by using the pylon API. The following code snippets illustrate using the API to set the exposure auto function:

```
// Select auto function ROI 1 (as an example) to allow
// Exposure Auto to control image brightness.
camera.AutoFunctionROISelector.SetValue
(AutoFunctionROISelector_ROI1);
camera.AutoFunctionROIUseBrightness.SetValue(true);

// Set the position and size of the auto function ROI
camera.AutoFunctionROIOffsetX.SetValue(0);
camera.AutoFunctionROIOffsetY.SetValue(0);
camera.AutoFunctionROIWidth.SetValue(1294);
camera.AutoFunctionROIHeight.SetValue(964);

// Set the maximum possible size of the selected auto function ROI
camera.AutoFunctionROIOffsetX.SetValue(0);
camera.AutoFunctionROIOffsetY.SetValue(0);
camera.AutoFunctionROIWidth.SetValue( camera.AutoFunctionROI-
Width.GetMax() );
camera.AutoFunctionROIHeight.SetValue( camera.AutoFunctionROI-
Height.GetMax() );

// Set the exposure time limits for exposure auto control
camera.AutoExposureTimeLowerLimit.SetValue(1000.0);
```

```
camera.AutoExposureTimeUpperLimit.SetValue(500000.0);

// Set the target gray value for the selected auto function
// The parameter value range refers to the theoretically maximum
// available range of gray values for the set pixel format.
// For example, if an 8 bit pixel format is set, a parameter value
// of 0.50196 will correspond to a gray value of 128.
camera.AutoTargetBrightness.SetValue(0.50196);

// Set the mode of operation for the exposure auto function
camera.ExposureAuto.SetValue(ExposureAuto_Continuous);
```

You can also use the Basler pylon Viewer application to easily set the parameters.

For more information about the pylon API and the pylon Viewer, see Section 3.1 on [page 62](#).

For general information about auto functions, see Section 7.15 on [page 299](#).

For information about Auto Function ROIs and how to set them, see Section 7.15.3 on [page 301](#).

For information about minimum allowed and maximum possible exposure time, see Section 6.9 on [page 180](#).



## 7.15.6 Auto Function Profile

If you want to use the gain auto function and the exposure auto function at the same time, the auto function profile feature also takes effect. The auto function profile specifies whether the gain or the exposure time will be kept as low as possible when the camera is making automatic adjustments to achieve a target average gray value for the pixel data from the Auto Function ROI that was related to the gain auto function and the exposure auto function. By default, the auto function profile feature minimizes gain.

If you want to use the gain auto and the exposure auto functions at the same time, set both functions for the continuous mode of operation.

Setting the camera with Basler pylon to use the gain auto function and the exposure auto function at the same time involves several steps:

### To set the auto function profile using Basler pylon:

1. Set the value of the Auto Function Profile parameter to specify whether gain or exposure time will be minimized during automatic adjustments.
2. Set the value of the Gain Auto parameter to the "continuous" mode of operation.
3. Set the value of the Exposure Auto parameter to the "continuous" mode of operation.

You can set the auto function profile from within your application software by using the pylon API. The following code snippet illustrates using the API to set the auto function profile. As an example, Gain Auto is set to be minimized during adjustments:

```
// Use Gain Auto and Exposure Auto simultaneously
camera.AutoFunctionProfile.SetValue(AutoFunctionProfile_MinimizeGain);
camera.GainAuto.SetValue(GainAuto_Continuous);
camera.ExposureAuto.SetValue(ExposureAuto_Continuous);
```

You can also use the Basler pylon Viewer application to easily set the parameters.

For more information about the pylon API and the pylon Viewer, see Section 3.1 on [page 62](#).

## 7.15.7 Balance White Auto

Balance White Auto is the "automatic" counterpart to manually setting the white balance. The balance white auto function is only available on color models.

Automatic white balancing is a two-step process. First, the Balance Ratio parameter values for red, green, and blue are each set to 1.5. Then, assuming a "gray world" model, the Balance Ratio parameter values are automatically adjusted such that the average values for the "red" and "blue" pixels match the average value for the "green" pixels.

Either Auto Function ROI can be selected to work with the balance white auto function.

If the selected Auto Function ROI does not overlap the Image ROI (see the "Auto Function ROI" section) the pixel data from the Auto Function ROI will not be used to control the white balance of the image. However, as soon as the Balance White Auto function is set to "once" operation mode, the Balance Ratio parameter values for red, green, and blue are each set to 1.5. These settings will control the white balance of the image.

For more information about setting the white balance "manually", see Section 7.14.3.1 on [page 283](#).

### To set the balance white function using Basler pylon:

1. Select the Auto Function ROI, for example, ROI 2.
2. Set the value of the Offset X, Offset Y, Width, and Height parameters for the ROI.
3. Set the value of the Exposure Auto parameter for the "once" or the "continuous" mode of operation.

You can set the white balance auto functionality from within your application software by using the pylon API. The following code snippets illustrate using the API to set the balance auto functionality:

```
// Select auto function ROI 2
camera.AutoFunctionROISelector.SetValue
(AutoFunctionROISelector_ROI2);
// Set the position and size of selected auto function ROI. In this
//example, we set
// auto function ROI to cover the entire sensor.
camera.AutoFunctionROIOffsetX.SetValue( 0 );
camera.AutoFunctionROIOffsetY.SetValue( 0 );
camera.AutoFunctionROIWidth.SetValue( camera.AutoFunctionROI-
Width.GetMax() );
camera.AutoFunctionROIHeight.SetValue( camera.AutoFunctionROI-
Height.GetMax() );

// Set mode of operation for balance white auto function
camera.BalanceWhiteAuto.SetValue(BalanceWhiteAuto_Once);
```

You can also use the Basler pylon Viewer application to easily set the parameters.

For more information about the pylon API and the pylon Viewer, see Section 3.1 on [page 62](#).

For general information about auto functions, see Section 7.15 on [page 299](#).

For information about Auto Function ROIs and how to set them, see Section 7.15.3 on [page 301](#).

## 7.15.8 Pattern Removal Auto

### 7.15.8.1 Monochrome Cameras

As a result of the camera's sensor design, images output by the monochrome acA3800-14um cameras can display a superposed artifact pattern resembling a checker pattern.

You can suppress the formation of the "checker pattern" to a great extent (pattern removal) by ensuring that the appropriate correction coefficients are applied to the original pixel values. Correction coefficients are automatically applied with each image acquisition and their application can not be disabled. Pattern Removal Auto is the auto function that allows you to ensure that the values of the correction coefficients are appropriate for each image acquisition. The values are **only** valid for the specific imaging conditions (see below) that were present when the correction coefficients were configured using Pattern Removal Auto.

The checker pattern originates from details of the sensor design: Neighboring pixels forming groups of four will respond identically to light only if its incidence is perpendicular to the sensor's surface. If the light arrives at an oblique angle, the four pixels of each group will respond slightly differently, giving raise to the checker pattern in the image.

### When to Use Pattern Removal Auto

Several conditions ("imaging conditions"; see below) govern the occurrence of the artifact checker pattern. Accordingly, for nearly complete checker pattern removal, you must ensure that the correction coefficient values are appropriate for the current imaging conditions: Whenever at least one of the relevant imaging conditions changes you must use the Pattern Removal Auto Function to generate new correction coefficient values. Otherwise, values will be used that are most likely invalid. In this case the checker pattern will not or only to a limited extent be removed while pixel values will be modified to some unknown and unwanted extents.

You must therefore generate new correction coefficient values when you enable or change one or more of the relevant "imaging conditions": Among them are the following:

- Optical system: exchange of lens, change of aperture, change of focus
- Illumination: change of the type of illumination, change of the arrangement of light sources, change of brightness
- Camera settings and features: The checker pattern depends on several camera settings and features, in particular exposure time, Black Level, Digital Shift, Binning Horizontal, Binning Vertical, LUT, some image ROI-related settings (Width, Height, OffsetX, OffsetY, CenterX, CenterY).



Make sure the Sequencer feature and all auto functions except Pattern Removal Auto are disabled when generating new correction coefficient values.



We strongly recommend to generate new correction coefficient values whenever you change the imaging conditions.

## The Pattern Removal Auto Function and Its Operation

The pattern removal auto function differs in some respects from other auto functions:

- It does not employ any Auto Function Region of Interest (Auto Function ROI).
- A "target" value does not exist. Instead, the auto function aims at generating correction coefficient values that will remove the checker pattern as far as possible.
- Only the "once" mode of operation is available to generate correction coefficient values.

The generation of appropriate correction coefficient values involves a sequence of three image acquisitions. After each acquisition correction coefficient values are generated and are used as input for the next acquisition. The values resulting from the third acquisition are the "final" ones and are used to perform pattern removal for all subsequent acquisitions until different correction coefficient values are loaded into the active set.

You can use hardware triggering, software triggering or internal triggering ("free run"). The generation of correction coefficient values after each frame start trigger occurs instantaneously and has no effect on the camera's frame rate. You can use the Single Frame or Continuous acquisition mode.

Newly generated correction values will be stored in the camera's volatile memory (the active set) and will be lost if the camera is reset or if power is switched off. You can, however, save them in one of the user sets 1 thorough 3. This provides you with the possibility of having correction values immediately available whenever you want to use them. In these cases, however, make sure the camera is operated at exactly the imaging conditions that were present when the correction coefficients values were generated.



We recommend not to use the Pattern Removal Auto Function when other auto functions are used unless the automatic changes are very limited and close to the imaging conditions for which the correction values were generated.

A similar restriction applies when using Pattern Removal Auto Function with the Sequencer feature. Note that correction coefficient values can not be stored in sequencer sets.

For more information about the active set and user sets, see Section 7.21 on [page 331](#).

For more information about the sequencer, see Section 7.7 on [page 221](#).

## Pattern Removal and Camera Startup

When the camera is switched on or reset, correction values from one of the user sets will be loaded into the active set if the user set was configured as user set default. Otherwise, factory-generated correction values will be loaded that are only appropriate for the imaging conditions chosen by the factory. Most likely, your imaging conditions will differ and you must therefore generate new correction values for your imaging conditions.

## Generating Correction Coefficient Values for Pattern Removal

### To generate correction coefficient values for pattern removal:

1. If possible, establish homogeneous illumination for the scene to be imaged.
2. Deactivate all camera settings and features (e.g. auto functions, sequencer) that would interfere with the generation of correction coefficient values.
3. Adjust the optical system, illumination, camera settings (e.g. exposure time, Digital Shift, Black Level) as desired for the coming image acquisitions. For best results, the image should display some average gray.
4. Set Pattern Removal Auto to Once.
5. Acquire three images to generate correction coefficient values. Ideally, the imaged scene will not change between acquisitions.

After the third acquisition, the optimum correction coefficient values are generated for the current imaging conditions. Pattern Removal Auto is automatically set to Off.

## Enabling the Pattern Removal Auto Function Using the pylon API

You can enable the Pattern Removal Auto Function from within your application software by using the Basler pylon API.

The following code snippet illustrates using the API to enable Pattern Removal Auto:

```
Camera.PatternRemovalAuto.SetValue(PatternRemovalAuto_Once);
```

After three image acquisitions the new correction values are generated and the camera automatically sets Pattern Removal Auto to Off (`PatternRemovalAuto_Off`).

For more information about the pylon API and the pylon Viewer, see Section 3.1 on [page 62](#).

For general information about auto functions, see Section 7.15 on [page 299](#).

## 7.15.8.2 Color Cameras

In acA3800-14uc and acA4600-10uc color cameras, groups of four pixels each display the same characteristic as their monochrome counterparts, that is, within a group, each pixel tends to show a different response to light. The resulting artifact effect produces slight color shifts. These can be corrected by using the white balance feature.

As with monochrome cameras, the artifact effect varies with certain "imaging conditions", that are defined by the optical system, the illumination, and several camera settings (see Section 7.15.8.1 on [page 314](#)). Accordingly, to correct for artifact color shifts, you must perform white balance whenever at least one of the relevant imaging conditions changes. This means also that you may have to perform white balance when you normally would not, for example after having changed the lens focus.

## 7.15.9 Using an Auto Function

The following instructions apply to all auto functions except the Pattern Removal Auto Function. Using the Pattern Removal Auto Function is described in Section 7.15.8 on [page 314](#).

### **To use an auto function using Basler pylon:**

1. Select an Auto Function ROI.
2. Assign the auto function you want to use to the selected Auto Function ROI.
3. Unassign the auto function you want to use from the other Auto Function ROI.
4. Set the position and size of the Auto Function ROI.
5. If necessary, set the lower and upper limits for the auto function's parameter value.
6. If necessary, set the target value.
7. If necessary, set the auto function profile to define priorities between auto functions.
8. Enable the auto function by setting it to "once" or "continuous".

For more information about the individual settings, see the previous sections that describe the individual auto functions.

## 7.16 Timestamp Value

The Timestamp Value feature allows you to obtain a timestamp by software command. The timestamp can be useful for comparing the camera's internal timing with the timings of other devices.

The timestamp is a 64 bit latched value and is based on a counter that counts the number of "timestamp clock ticks" [ns] generated by the camera.



Note that there is an unspecified and variable delay between sending the software command and it becoming effective, i.e. the moment when the clock ticks are actually read.

### To obtain the timestamp value:

1. Execute the TimestampLatch command.
2. Retrieve the TimestampLatchValue parameter value.

You can execute the TimestampLatch command and retrieve the TimestampLatchValue parameter value from within your application software by using the Basler pylon API. The following code snippet illustrates the procedure using the API:

```
// execute a command to obtain a timestamp and retrieve the timestamp value [ns]
camera.TimestampLatch.Execute();
int64_t i = camera.TimestampLatchValue.GetValue();
```

You can also use the Basler pylon Viewer application to easily obtain the timestamp.

For more information about the pylon Camera Software Suite and the pylon Viewer, see Section 3.1 on [page 62](#).

## 7.17 Event Notification

When event notification is set to "on", the camera can generate an "event" and transmit a related event message to the computer whenever a specific situation has occurred.

The camera can generate and transmit events for the following types of situations:

- The camera is ready to receive a frame start trigger (FrameStartWait event).
- A frame start trigger has occurred (FrameStart event).
- Overtriggering of the frame start trigger has occurred (FrameStartOvertrigger event).

This happens, if the camera receives a frame start trigger signal when it is not in a "waiting for frame start trigger" acquisition status.



If the frame start overtrigger event is only available when image acquisition is carried out using an external hardware trigger.

- The camera is ready to receive a frame burst start trigger (FrameBurstStartWait event).
- A frame burst start trigger has occurred (FrameBurstStart event).
- Overtriggering of the frame burst start trigger has occurred (FrameBurstStartOvertrigger event).

This happens, if the camera receives a frame burst start trigger signal when it is not in a "waiting for frame burst start trigger" acquisition status.

- The end of an exposure has occurred (ExposureEnd event).
- The camera's device temperature has reached a critical level (Critical Temperature event) or, upon further heating, the camera has entered the over temperature mode (Over Temperature event). For more information about the related temperature levels and the over temperature mode, see Section 1.10.3 on [page 52](#).

An event message will be sent to the computer when transmission time is available. Note, however that event messages can be lost when the camera operates at high frame rates. No mechanism is available to monitor the number of event messages lost.

Note also that an event message is only useful when its cause still applies at the time when the event is received by the computer.



## An Example of Event Notification

An example related to the Frame Start Overtrigger event illustrates how event notification works. The example assumes that your system is set for event notification (see below) and that the camera has received an external frame start trigger when the camera is not in a "waiting for frame start trigger" acquisition status. In this case:

1. A Frame Start Overtrigger event is created. The event contains the event in the strict sense plus supplementary information:
  - An Event Type Identifier.* In this case, the identifier would show that a frame start overtrigger type event has occurred.
  - A Timestamp.* This is a timestamp indicating when the event occurred. (The time stamp timer starts running at power off/on or at camera reset. The timestamp [ns] is a 64 bit value.)
2. The event message will be sent to the computer if transmission time is available and if no major number of younger event messages were generated.
  - a. After the camera sends an event message, it waits for an acknowledgement. If no acknowledgement is received within a specified timeout, the camera will resend the event message. If an acknowledgement is still not received, the timeout and resend mechanism will repeat until a specified maximum number of retries is reached. If the maximum number of retries is reached and no acknowledge has been received, the message will be dropped. While the camera is waiting for an acknowledgement, no new event messages can be transmitted.
3. Event notification involves making some additional software-related steps and settings. For more information, see the "Camera Events" code sample included with the pylon software development kit.

## Setting Your System for Event Notification

Event notification must be enabled in the camera and some additional software-related settings must be made. This is described in the "Camera Events" code sample included with the pylon software development kit.

Event notification must be specifically set up for each type of event using the parameter names of event and supplementary information. The following table lists the relevant parameter names:

| Event                         | Event Parameter Name            | Supplementary Information Parameter Name |
|-------------------------------|---------------------------------|--|
| Frame Start                   | EventFrameStart                 | EventFrameStartTimestamp                 |
| Frame Start Overtrigger       | EventFrameStartOvertrigger      | EventFrameStartOvertriggerTimestamp      |
| Frame Start Wait              | EventFrameStartWait             | EventFrameStartWaitTimestamp             |
| Frame Burst Start             | EventFrameBurstStart            | EventFrameBurstStartTimestamp            |
| Frame Burst Start Overtrigger | EventFrameBurstStartOvertrigger | EventFrameBurstStartOvertriggerTimestamp |
| Frame Burst Start Wait        | EventFrameBurstStartWait        | EventFrameBurstStartWaitTimestamp        |
| Exposure End                  | EventExposureEnd                | EventExposureEndFrameID                  |
|                               |                                 | EventExposureEndTimestamp                |
| Critical Temperature*         | EventCriticalTemperature        | EventCriticalTemperatureTimestamp        |
| Over Temperature*             | EventOverTemperature            | EventOverTemperatureTimestamp            |

Table 57: Parameter Names of Events and Supplementary Information

\* Only available for acA640-750u, acA800-510u, acA1300-200u, acA1920-40u, acA1920-150u, acA1920-155u, acA2040-55u, acA2040-120u, acA2440-35u, acA2440-75u, and acA2500-60u cameras.

You can enable event notification and make the additional settings from within your application software by using the pylon API. The pylon Camera Software Suite includes a "Grab\_CameraEvents" code sample that illustrates the entire process.

For more detailed information about using the pylon API, refer to the Basler pylon Programmer's Guide and API Reference.

## 7.18 Test Images

All cameras include the ability to generate test images. Test images are used to check the camera's basic functionality and its ability to transmit an image to the host computer. Test images can be used for service purposes and for failure diagnostics. For test images, the image is generated internally by the camera's logic and does not use the optics, the imaging sensor, or the ADC. Five test images are available for monochrome cameras and six test images for color cameras.

### The Effect of Camera Settings on Test Images

When any of the test image is active, the camera's analog features such as gain, black level, and exposure time have no effect on the images transmitted by the camera. For test images 1, 2, 3 and 6, the camera's digital features, such as the luminance lookup table, will also have no effect on the transmitted images. But for test images 4 and 5, the camera's digital features will affect the images transmitted by the camera. This makes test images 4 and 5 a good way to check the effect of using a digital feature such as the luminance lookup table.

### Enabling a Test Image

The Test Image Selector is used to set the camera to output a test image. You can set the value of the Test Image Selector to one of the test images, e.g. to test image 1 (see below), for test image 1, or to "off".

You can set the Test Image Selector from within your application software by using the Basler pylon API. The following code snippets illustrate using the API to set the selector:

```
// Set for no test image
camera.TestImageSelector.SetValue(TestImageSelector_Off);
// Set for the first test image
camera.TestImageSelector.SetValue(TestImageSelector_Testimage1);
```

You can also use the Basler pylon Viewer application to easily set the parameters.

For more information about the pylon API and the pylon Viewer, see Section 3.1 on [page 62](#).

## Test Image Reset and Hold

When the Test Image Reset and Hold command is issued, all gradients will be displayed at their starting positions and will stay fixed.

The command can be applied to both, static and dynamic test images. However, the command is always "true" for static test images and therefore is only useful for dynamic (moving gradient-) test images.

Test Image Reset and Hold allows you to obtain a defined and fixed state for each test image.

You can issue the Test Image Reset and Hold command from within your application software by using the Basler pylon API. The following code snippet illustrates using the API:

```
// Set test image reset and hold and read the current setting
camera.TestImageResetAndHold.SetValue(true);
bool b = camera.TestImageResetAndHold.GetValue();
```

You can also use the Basler pylon Viewer application to easily set the parameter.

For more information about the pylon API and the pylon Viewer, see Section 3.1 on [page 62](#).

## 7.18.1 Test Image Descriptions

### Test Image 1 - Fixed Diagonal Gray Gradient (8 bit)

The 8 bit fixed diagonal gray gradient test image is best suited for use when the camera is set for monochrome 8 bit output. The test image consists of fixed diagonal gray gradients ranging from 0 to 255.

If the camera is set for 8 bit output and is operating at full resolution, test image one will look similar to Figure 111.

The mathematical expression for this test image:

$$\text{Gray Value} = [\text{column number} + \text{row number}] \text{ MOD } 256$$

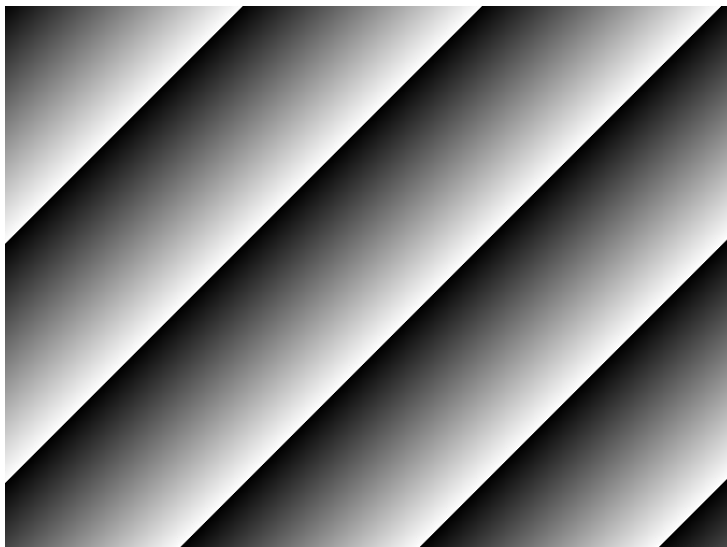

Fig. 111: Test Image One

### Test Image 2 - Moving Diagonal Gray Gradient (8 bit)

The 8 bit moving diagonal gray gradient test image is similar to test image 1, but it is not stationary. The image moves by one pixel from right to left whenever a new image acquisition is initiated. The test pattern uses a counter that increments by one for each new image acquisition.

The mathematical expression for this test image is:

$$\text{Gray Value} = [\text{column number} + \text{row number} + \text{counter}] \text{ MOD } 256$$



When a camera model listed in Section 1.10.3 on [page 52](#) reaches the device temperature of 90 °C (+194.0 °F), the camera enters the over temperature mode. In this mode, the camera no longer acquires images but delivers test image 2.

For more information about the over temperature mode and how to leave it, see Section 1.10.3 on [page 52](#) and Section 1.10.3 on [page 52](#)Section 1.10.2 on [page 52](#), respectively.

### Test Image 3 - Moving Diagonal Gray Gradient (10 bit or 12 bit)

The moving diagonal gray gradient test image 3 is similar to test image 2, but it is a 10 bit or 12 bit pattern (depending on camera model). The image moves by one pixel from right to left whenever a new image acquisition is initiated. The test pattern uses a counter that increments by one for each new image acquisition.

The mathematical expression for this test image is:

- For 10 bit output: Gray Value = [column number + row number + counter] MOD 1024
- For 12 bit output: Gray Value = [column number + row number + counter] MOD 4096

### Test Image 4 - Moving Diagonal Gray Gradient Feature Test (8 bit)

The basic appearance of test image 4 is similar to test image 2 (the 8 bit moving diagonal gray gradient image). The difference between test image 4 and test image 2 is this: if a camera feature that involves digital processing is enabled, test image 4 **will** show the effects of the feature while test image 2 **will not**. This makes test image 4 useful for checking the effects of digital features such as the luminance lookup table.

### Test Image 5 - Moving Diagonal Gray Gradient Feature Test (12 bit)

The basic appearance of test image 5 is similar to test image 3. The difference between test image 5 and test image 3 is this: if a camera feature that involves digital processing is enabled, test image 5 **will** show the effects of the feature while test image 3 **will not**. This makes test image 5 useful for checking the effects of digital features such as the luminance lookup table.

## Test Image 6 - Moving Diagonal Color Gradient

The moving diagonal color gradient test image is only available on color cameras. As shown in Figure 112, test image six consists of diagonal color gradients (when a Mono pixel format is selected, gray gradients will appear). The image moves by one pixel from right to left whenever you signal the camera to capture a new image.



Fig. 112: Test Image Six

## 7.19 Device Information Parameters

Each camera includes a set of "device information" parameters. These parameters provide some basic information about the camera. The device information parameters include:

- Device Vendor Name (read only) - contains the camera vendor's name.
- Device Model Name (read only) - contains the model name of the camera.
- Device Manufacturer Info (read only) - can contain some information about the camera manufacturer. This string usually indicates "none".
- Device Version (read only) - contains the device version number for the camera.
- Device Firmware Version (read only) - contains the version of the firmware in the camera.
- Device Serial Number (read only) - contains the serial number of the camera.
- Device User ID (read / write) - is used to assign a user defined name to a device. This name will be displayed in the Basler pylon Viewer and the Basler pylon USB Configurator. The name will also be visible in the "friendly name" field of the device information objects returned by pylon's device enumeration procedure.
- Device Scan Type (read only) - contains the scan type of the camera, for example, area scan.
- Sensor Width (read only) - contains the physical width of the sensor in pixels.
- Sensor Height (read only) - contains the physical height of the sensor in pixels.
- Max Width (read only) - Indicates the camera's maximum region of interest (ROI) width setting for the current OffsetX settings.
- Max Height (read only) - Indicates the camera's maximum region of interest (ROI) height setting for the current OffsetY settings.

You can read the values for all of the device information parameters or set the value of the Device User ID parameter from within your application software by using the Basler pylon API. The following code snippets illustrate using the API to read the parameters or write the Device User ID:

```
// Read the Device Vendor Name parameter
GenICam::gcstring s = camera.DeviceVendorName.GetValue();

// Read the Device Model Name parameter
GenICam::gcstring s = camera.DeviceModelName.GetValue();

// Read the Device Manufacturer Info parameter
GenICam::gcstring s = camera.DeviceManufacturerInfo.GetValue();

// Read the Device Version parameter
GenICam::gcstring s = camera.DeviceVersion.GetValue();

// Read the Device Firmware Version parameter
```



```
GenICam::gcstring s = camera.DeviceFirmwareVersion.GetValue();

// Read the Device Serial Number parameter
GenICam::gcstring s = camera.DeviceSerialNumber.GetValue();

// Write and read the Device User ID parameter
camera.DeviceUserID.SetValue("CAM_1");
GenICam::gcstring s = camera.DeviceUserID.GetValue();

// Read the Device Scan Type parameter
DeviceScanTypeEnums e = camera.DeviceScanType.GetValue();

// Set the Device Link Selector parameter
camera.DeviceLinkSelector.SetValue(0);

// Set the Device Link Speed parameter
camera.DeviceLinkSelector.SetValue(0);

// Set the Device Link Throughput Limit Mode parameter
camera.DeviceLinkSelector.SetValue(0);
camera.DeviceLinkThroughputLimitMode.SetValue(DeviceLinkThroughputLimitMode_On);

// Set the Device Link Throughput Limit parameter ([Bps])
camera.DeviceLinkSelector.SetValue(0);
camera.DeviceLinkThroughputLimit.SetValue(419430400);

// Read the Device Link Current Throughput parameter ([Bps])
camera.DeviceLinkSelector.SetValue(0);
int64_t i = camera.DeviceLinkCurrentThroughput.GetValue();

// Read the Device SFNC Version Major parameter
int64_t i = camera.DeviceSFNCVersionMajor.GetValue();

// Read the Device SFNC Version Minor parameter
int64_t i = camera.DeviceSFNCVersionMinor.GetValue();

// Read the Device SFNC Version Sub Minor parameter
int64_t i = camera.DeviceSFNCVersionSubMinor.GetValue();
```

```
// Read the SensorWidth parameter
int64_t i = camera.SensorWidth.GetValue();

// Read the SensorHeight parameter
int64_t i = camera.SensorHeight.GetValue();

// Read the WidthMax parameter
int64_t i = camera.WidthMax.GetValue();

// Read the HeightMax parameter
int64_t i = camera.HeightMax.GetValue();
```

You can also use the Basler pylon Viewer application to easily read the parameters and to read or write the Device User ID.

You can also use the Basler pylon USB Configurator to read the Device User ID.

For more information about the pylon API, the pylon Viewer, and the pylon USB Configurator, see Section 3.1 on [page 62](#).

## 7.20 User Defined Values

The camera can store five "user defined values". Each value is a 32 bit signed integer value that you can set and read as desired. The values simply serve as convenient storage locations for the camera user and have no impact on the operation of the camera.

The values are designated as Value 1 through Value 5.

### Setting User Defined Values

#### To set a user defined value using Basler pylon:

1. Set the User Defined Value Selector the desired value, e.g. to Value 1.
2. Set the User Defined Value parameter to the desired value for the selected value.

You can use the pylon API to set the User Defined Value Selector and the User Defined Value parameter value from within your application software. The following code snippet illustrates using the API to set the selector and the parameter value for Value 1 to 1000:

```
// Set user defined value 1
camera.UserDefinedValueSelector.SetValue( UserDefinedValueSelector_Value1 );
camera.UserDefinedValue.SetValue(1000);

// Get the value of user defined Value 1
camera.UserDefinedValueSelector.SetValue( UserDefinedValueSelector_Value1 );
int64_t i = camera.UserDefinedValue.GetValue();
```

You can also use the Basler pylon Viewer application to easily set the parameters.

For more information about the Basler pylon API and the pylon Viewer, see Section 3.1 on [page 62](#).

## 7.21 User Sets

### Normal Implementation

A user set is a group of parameter values with all the settings needed to control the camera.

There are three basic types of user sets:

- a selection of user sets -
  - some that can be configured by the user and
  - some with factory setups that can not be changed
- the user set configured as the default ("user set default").
- the active user set.

### The Active User Set

The active user set contains most of the camera's current parameter settings and is part of the active set. The active set contains all of the camera's current parameter settings and thus determines the camera's performance, and therefore, what your image currently looks like. When you change parameter settings using the pylon API or the pylon Viewer, you are making changes to the active set. The active set is located in the camera's volatile memory and the settings are lost, if the camera is reset or if power is switched off.

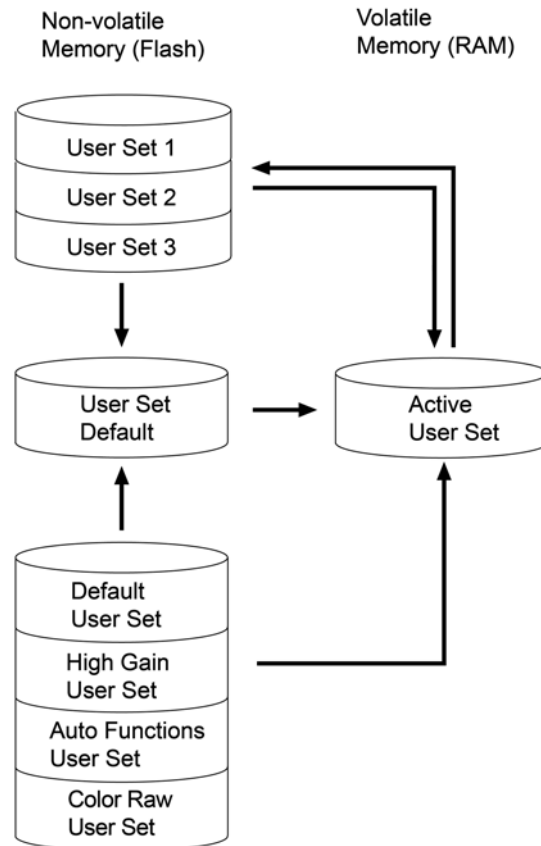

Fig. 113: User Sets

### The User Sets to Be Configured by the User

As mentioned above, the active configuration set is stored in the camera's volatile memory and the settings are lost, if the camera is reset or if power is switched off. The camera can save most of the settings from the current active set to a reserved area in the camera's non-volatile memory. A user set that has been saved in the non-volatile memory is not lost when the camera is reset or switched off. There are three reserved areas in the camera's non-volatile memory available for saving user sets that can be configured by the user. The three available user sets are called User Set 1, User Set 2, and User Set 3.

When the camera is running, a saved user set can be loaded into the active set. A saved user set can also be designated as the User Set Default, i.e. as the "startup" set, that will be loaded into the active set whenever the camera is powered on or reset. Instructions for loading a saved user set into the active set and for designating which set will be the startup set appear below in Section 7.21.3 on [page 335](#) and Section 7.21.4 on [page 336](#), respectively.



- The values for sequencer sets cannot be saved in any user set.
- The values for the luminance lookup table are not saved in any user set and are lost when the camera is reset or switched off. If you are using the lookup table feature, you must reenter the lookup table values after each camera startup or reset.
- The current luminance lookup table is not changed when a user set is loaded into the active user set.

## The User Sets with Factory Setups

When a camera is manufactured, numerous tests are performed on the camera and three factory optimized setups are determined. The three user sets with factory optimized setups are:

- The Default User Set with a standard factory setup that is optimized for average conditions and will provide good camera performance in many common applications. In the standard factory setup, the gain is set to a low value, and all auto functions are set to off.
- The High Gain User Set is similar to the Default User Set, but the gain is set to + 6 dB.
- The Auto Functions User Set is similar to the Default User Set, but the Gain Auto and the Exposure Auto auto functions are both enabled and are set to the continuous mode of operation. During automatic parameter adjustment, gain will be kept to a minimum.
- The Color Raw User Set is available in some color cameras. The user set is similar to the Default User Set, but no color enhancement feature is active.

The user sets with factory setups are saved in permanent files in the camera's non-volatile memory. They are not lost when the camera is reset or switched off and they can not be changed.

For more information about auto functions, see Section 7.15 on [page 299](#).

For more information about color enhancement features, see Section 7.14.3 on [page 283](#).

## The User Set Default

You can designate one of the six user sets (the Default User Set, High Gain User Set, Auto Functions User Set, User Set 1, User Set 2, User Set 3) as the User Set Default, i.e. as the startup user set. The startup user set will automatically be loaded into the active set whenever the camera starts up at power on or after a reset. Instructions for designating a user set as the User Set Default appear below.

## 7.21.1 Selecting a User Set

If you want to load any of the user sets into the Active User Set or if you want to configure User Set 1, User Set 2 or User Set 3, you must first select the desired user set.

When the camera is delivered, the Default User Set will be selected.

### To select a User Set using Basler pylon:

1. Set the User Set Selector to the desired user set (one of the factory setups, User Set 1, User Set 2 or User Set 3).

You can set the User Set Selector from within your application software by using the Basler pylon API. The following code snippet illustrates using the API to set the selector:

If you want to select the Default User Set:

```
camera.UserSetSelector.SetValue(UserSetSelector_Default);
```

If you want to select the High Gain User Set:

```
camera.UserSetSelector.SetValue(UserSetSelector_HighGain);
```

If you want to select the Auto Functions User Set:

```
camera.UserSetSelector.SetValue(UserSetSelector_AutoFunctions);
```

If you want to select the Color Raw User Set:

```
camera.UserSetSelector.SetValue(UserSetSelector_ColorRaw);
```

If you want to select e.g. User Set 1:

```
camera.UserSetSelector.SetValue(UserSetSelector_UserSet1);
```

You can also use the Basler pylon Viewer to easily set the selector.

For more information about the Basler pylon API and the pylon Viewer, see Section 3.1 on [page 62](#).

## 7.21.2 Saving a User Set

After having set parameter values as desired, you can save them for further use into User Set 1, User Set 2 or User Set 3. Saving the parameter values also means saving them from the current active set into a user set in the camera's non-volatile memory.

### To save a User Set from the active set into the non-volatile memory using Basler pylon:

1. Make changes to the camera's settings until the camera is operating in a manner that you would like to save.
2. Set the User Set Selector to User Set 1, User Set 2, or User Set 3.
3. Execute a User Set Save command to save the active set to the selected user set.



Saving an active set to a user set in the camera's non-volatile memory will overwrite any parameters that were previously saved in that user set.



Saving a user set into the non-volatile memory active set is only allowed when the camera is idle, i.e. when it is not acquiring images continuously or does not have a single image acquisition pending.

You can set the User Set Selector and execute the User Set Save command from within your application software by using the pylon API. The following code snippet illustrates using the API to set the selector to e.g. User Set 1 and execute the command:

```
camera.UserSetSelector.SetValue(UserSetSelector_UserSet1);  
camera.UserSetSave.Execute( );
```

For detailed information about using the pylon API, refer to the Basler pylon Programmer's Guide and API Reference.

You can also use the Basler pylon Viewer application to easily set the parameters.

For more information about the Basler pylon API and the pylon Viewer, see Section 3.1 on [page 62](#).

## 7.21.3 Loading User Set into the Active User Set

You can load any user set from the camera's non-volatile memory into the camera's active user set. Accordingly, you can load the user sets with factory setup (Default User Set, High Gain User Set, Auto Function User Set) and the user sets with parameter values previously saved by the user (User Set 1, User Set 2, User Set 3 or a subset) into the camera's non-volatile memory.

When you load a user set, the loaded set overwrites the parameter settings in the active set. Since the settings in the active set control the current operation of the camera, the settings from the loaded set will now be controlling the camera.

### To load a User Set from the non-volatile memory into the active user set using Basler pylon:

1. Set the User Set Selector to the desired User Set, e.g. User Set 2.
2. Execute a User Set Load command to load the selected user set into the active user set.

You can set the User Set Selector and execute the User Set Load command from within your application software by using the pylon API. The following code snippets illustrate using the API to set the selector and execute the command:

If you want to load e.g. User Set 2:

```
camera.UserSetSelector.SetValue(UserSetSelector_UserSet2);  
camera.UserSetLoad.Execute( );
```

If you want to load the Default User Set:

```
camera.UserSetSelector.SetValue(UserSetSelector_Default);  
camera.UserSetLoad.Execute( );
```

If you want to load the High Gain User Set:

```
camera.UserSetSelector.SetValue(UserSetSelector_HighGain);  
camera.UserSetLoad.Execute( );
```

If you want to load the Auto Functions User Set:

```
camera.UserSetSelector.SetValue(UserSetSelector_AutoFunctions);  
camera.UserSetLoad.Execute( );
```

If you want to load the Color Raw User Set:

```
camera.UserSetSelector.SetValue(UserSetSelector_ColorRaw);  
camera.UserSetLoad.Execute( );
```





Loading a user set into the active set is only allowed when the camera is idle, i.e. when it is not acquiring images continuously or does not have a single frame acquisition pending.

Loading the Default User Set with the standard factory setup into the active set is a good course of action, if you have grossly misadjusted the settings in the camera and you are not sure how to recover. The standard factory setup is optimized for use in typical situations and will provide good camera performance in most cases.

You can also use the Basler pylon Viewer to easily set the selector.

For more information about the Basler pylon API and the pylon Viewer, see Section 3.1 on [page 62](#).

## 7.21.4 Designating a User Set as the User Set Default

You can designate any user set from the camera's non-volatile memory as the User Set Default. Accordingly, you can designate the user sets with factory setup (Default User Set, High Gain User Set, Auto Function User Set) and the user sets with parameter values previously saved by the user (User Set 1, User Set 2, User Set 3 or a subset).

The configuration set that you designate as the User Set Default will act as the startup set and will be loaded into the active user set whenever the camera starts up at power on or after a reset.



Selecting which user set will serve as the User Set Default is only allowed when the camera is idle, i.e. when it is not acquiring images continuously or does not have a single frame acquisition pending.

Selecting the user set with the standard factory setup as the User Set Default and then loading the Default User Set into the active set is a good course of action, if you have grossly misadjusted the settings in the camera and you are not sure how to recover. The standard factory setup is optimized for use in typical situations and will provide good camera performance in most cases.

**To designate a user set as the user set default using Basler pylon:**

The User Set Default Selector is used to select the startup set:

1. Set the User Set Default Selector to the desired User Set.

You can set the User Set Default Selector from within your application software by using the pylon API. The following code snippets illustrate using the API to set the selector:

If you want to designate the Default User Set as User Set Default:

```
camera.UserSetDefault.SetValue(UserSetDefault_Default);
```

If you want to designate the High Gain User Set as User Set Default:

```
camera.UserSetDefault.SetValue(UserSetDefault_HighGain);
```

If you want to designate the Auto Functions User Set as User Set Default:

```
camera.UserSetDefault.SetValue(UserSetDefault_AutoFunctions);
```

If you want to designate the Color Raw User Set as User Set Default:

```
camera.UserSetDefault.SetValue(UserSetDefault_ColorRaw);
```

If you want to designate e.g. User Set 1 as User Set Default:

```
camera.UserSetDefault.SetValue(UserSetDefault_UserSet1);
```

For more information about the Basler pylon API and the pylon Viewer, see Section 3.1 on [page 62](#).

## 7.22 Line Pitch

For information about the availability of the line pitch feature on a specific camera model, see Table 41 on [page 196](#) and Table 42 on [page 197](#).

The line pitch feature is useful if you want that the data size, related to a line of pixels, will be perfectly aligned with cache lines. Data alignment can improve performance and is in general desired for embedded systems.

"Line pitch" designates the number of bytes that relate to all pixel data of a line of pixels, subject to the current ROI width and the current pixel format.

Generally, the line pitch obtained from an image acquisition (the "original" line pitch) will not include the right number of bytes for perfect alignment with cache lines of given sizes (typically 32 or 64 bytes). For perfect alignment, the line pitch must be a multiple of a given cache line size. To allow perfect alignment, the line pitch feature will expand the original line pitch as far as necessary to produce the "minimum required line pitch". The expansion is accomplished by appending the minimum required bytes as zeros to the original pixel data (data structure padding).

**Example:** Assume a camera is set for an ROI width of 352 pixels and for Mono 8 pixel format. Also assume, that the pixel data from each ROI line must align with a cache line size of 64 bytes.

For each frame and with the above settings, each pixel will deliver one byte and each ROI line will include 352 bytes of pixel data (the original line pitch; see Figure 114 on [page 339](#)). This amount of data can not be aligned with 64-byte cache lines as 352 can not be divided by 64 without remainder. Alignment is, however, possible, when the line data are padded with 32 bytes (as zeros) to produce the minimum required line pitch of 384 bytes.

**Without padding**

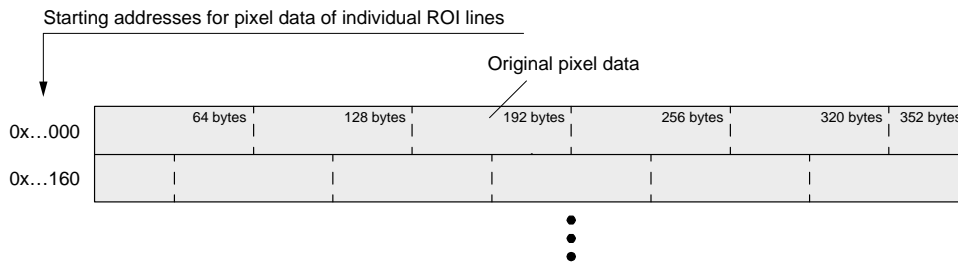

**With padding**

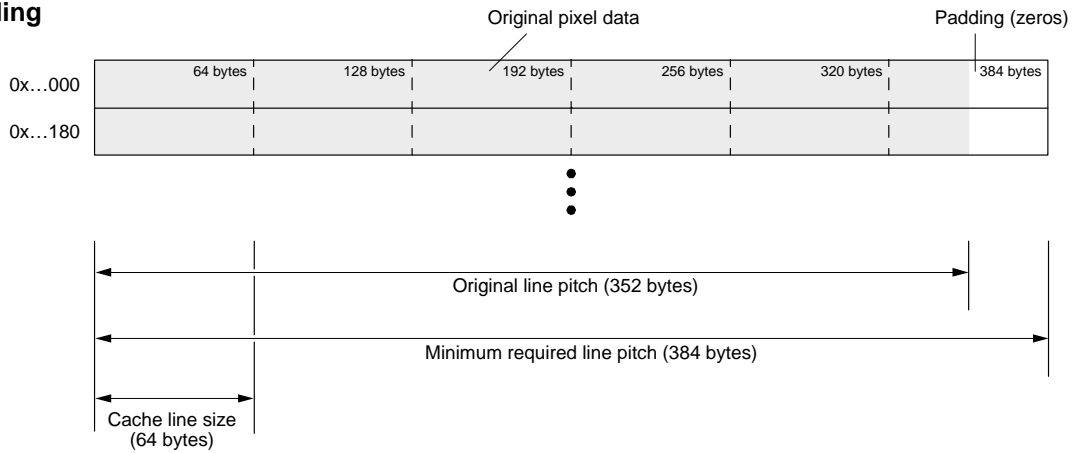

Fig. 114: Storage of Pixel Data from the First Two ROI Lines, Without and With Padding for 64-byte Alignment

- The line pitch feature is not available for packed pixel formats providing 12 bit output per pixel (Mono 12p, Bayer XX 12p).
- The line pitch feature can be used in combination with features that involve the concept of virtual pixels (e.g. the binning feature). In these cases, the line pitch feature acts on data from virtual pixels.

Note that the line pitch feature acts as the last feature, before the data are transmitted out of the camera.
- Chunk data, that may be appended to a frame, must not be considered when calculating the desired line pitch.

For more information about the chunk feature, see Section 7.23 on [page 342](#).

## Minimum Required Line Pitch

To achieve the required padding, you must set the LinePitch parameter value. This value will actually be the minimum required line pitch value that is calculated as shown below (employing the floor function).

NPX = Current number of pixels per line (subject to the current ROI width)

BD [byte] = Current bit depth of pixel data (one or two bytes per pixel, subject to the current pixel format; see above)

CLP [byte] = Current line pitch; see formula 1

RLP [byte] = Required minimum line pitch; see formula 2

ALIG [byte] = Data size to which the line pitch must be aligned (equivalent to cache line size)

### Formula 1:

$$\text{CLP} = \text{NPX} \times \text{BD}$$

### Formula 2:

$$\text{RLP} = \left( \left\lceil \frac{\text{CLP} + (\text{ALIG} - 1)}{\text{ALIG}} \right\rceil \times \text{ALIG} \right)$$

#### To calculate the required minimum line pitch:

1. Determine the current line pitch
  - by using formula 1 or
  - by reading the LinePitch parameter value or
  - by reading the Stride parameter value.
2. Calculate the required minimum line pitch using formula 2.
3. Enable the LinePitch feature.
4. Set the LinePitch parameter using the value calculated in step 2 to achieve the required padding.



When you enable the LinePitch feature, the feature will automatically provide padding for 4-byte alignment, without the need for setting the LinePitch parameter value.

You can manually adjust the line pitch from within your application software by using the Basler pylon API. The following code snippet illustrates using the API to set the parameter values. As an example, the settings are consistent with the example given above (32-byte alignment):

```
// Enable the line pitch feature and get informed about the enabling
camera.LinePitchEnable.SetValue(true);
bool b = camera.LinePitchEnable.GetValue();
// Read the current line pitch
int64_t i = camera.LinePitch.GetValue();
// Set the minimum required line pitch
camera.LinePitch.SetValue(384);
```

You can also use the Basler pylon Viewer application to easily set the parameters.

For more information about the pylon API and the pylon Viewer, see Section 3.1 on [page 62](#).

## 7.23 Chunk Features



Chunk features are not available for the acA1920-155 camera.

### 7.23.1 What are Chunk Features?

In most cases, enabling a camera feature will simply change the behavior of the camera. The Test Image feature is a good example of this type of camera feature. When the Test Image feature is enabled, the camera outputs a test image rather than a captured image.

When chunk features are enabled, the camera

- develops some sort of information about each image that it acquires and
- adds the information to each image as a trailing data "chunk" when the image is transferred to the host computer.

Examples of this type of camera feature are the Gain chunk feature and the Timestamp chunk feature:

- When the Gain chunk feature is used, the camera checks, after an image is captured, the Gain All parameter value used for the image acquisition and develops a data chunk.
- When the Timestamp chunk feature is used, the camera develops a time stamp data chunk.
- The gain data chunk and the timestamp data chunk are appended as trailing data to the related image data as the image is transferred from the camera.

After the data chunks were transmitted to the computer they must be retrieved. For more information about retrieving chunk data, see Section 7.23.5 on [page 352](#).

### 7.23.2 Using Chunk Features

Using chunk features is a three step process:

- Use the **Chunk Selector** parameter to select the desired chunk feature, e.g. the Gain chunk feature.
- Set the **Chunk Enable** parameter to true to prepare the selected chunk feature to be appended to image data
- Set the **Chunk Mode Active** parameter to true to generate chunk data for the selected chunk feature and append them to the related image data.

If you want to use more than one chunk feature, you can prepare several chunk features by using Chunk Selector and Chunk Enable before setting the Chunk Mode Active parameter.

For more information about the three steps, see below.

## 7.23.3 Data Chunks

You can select the individual data chunks to be appended to image data by selecting the kind of data chunk and then enabling it. For details, see below.

### 7.23.3.1 Gain Chunk

The gain chunk feature adds a chunk to each acquired image containing the gain All parameter value used for the image acquisition.

#### To enable the gain chunk:

1. Use the Chunk Selector to select the Gain chunk.
2. Use the Chunk Enable parameter to set the value of the gain chunk to true.

Once the gain chunk is enabled and Chunk Mode Active (see Section 7.23.4 on [page 351](#)) is enabled, the camera appends a gain chunk to each acquired image.

After an image with an appended chunk has been received by your computer the chunk must be retrieved. For information about retrieving data chunks, see Section 7.23.5 on [page 352](#).

You can set the Chunk Selector and Chunk Enable parameter value from within your application software by using the Basler pylon Camera Software Suite. The following code snippet illustrates using the API to activate the chunk mode, select the gain chunk, and enable the gain chunk:

```
// make chunk mode active, select and enable Gain chunk
camera.ChunkSelector.SetValue(ChunkSelector_Gain);
camera.ChunkEnable.SetValue(true);
```

You can also use the Basler pylon Viewer application to easily set the parameters.

For more information about the pylon Camera Software Suite and the pylon Viewer, see Section 3.1 on [page 62](#).



### 7.23.3.2 Line Status All Chunk

The line status all chunk feature adds a chunk to each acquired image containing the line status all parameter value

**To enable the line status all chunk:**

1. Use the Chunk Selector to select the Line Status All chunk.
2. Use the Chunk Enable parameter to set the value of the line status all chunk to true.

Once the line status all chunk is enabled and Chunk Mode Active (see Section 7.23.4 on [page 351](#)) is enabled, the camera appends a line status all chunk to each acquired image.

After an image with an appended chunk has been received by your computer the chunk must be retrieved. For information about retrieving data chunks, see Section 7.23.5 on [page 352](#).

You can set the Chunk Selector and Chunk Enable parameter value from within your application software by using the Basler pylon Camera Software Suite. The following code snippet illustrates using the API to activate the chunk mode, select the line status all chunk, and enable the line status all chunk:

```
// make chunk mode active, select and enable Line Ststus All chunk
camera.ChunkSelector.SetValue(ChunkSelector_LineStatusAll);
camera.ChunkEnable.SetValue(true);
```

You can also use the Basler pylon Viewer application to easily set the parameters.

For more information about the pylon Camera Software Suite and the pylon Viewer, see Section 3.1 on [page 62](#).

### 7.23.3.3 Exposure Time Chunk

The exposure time chunk feature adds a chunk to each acquired image containing the exposure time parameter value in  $\mu\text{s}$  used for the image acquisition.

**To enable the exposure time chunk:**

1. Use the Chunk Selector to select the Exposure Time chunk.
2. Use the Chunk Enable parameter to set the value of the chunk to true.

Once the exposure time chunk is enabled and Chunk Mode Active (see Section 7.23.4 on [page 351](#)) is enabled, the camera appends an exposure time stamp chunk to each acquired image.

After an image with an appended chunk has been received by your computer the chunk must be retrieved. For information about retrieving data chunks, see Section 7.23.5 on [page 352](#).

You can set the Chunk Selector and Chunk Enable parameter value from within your application software by using the Basler pylon Camera Software Suite. The following code snippet illustrates using the API to activate the chunk mode, select the exposure time chunk, and enable the exposure time chunk:

```
// make chunk mode active, select and enable Exposure Time chunk
camera.ChunkSelector.SetValue(ChunkSelector_ExposureTime);
camera.ChunkEnable.SetValue(true);
```

You can also use the Basler pylon Viewer application to easily set the parameters.

For more information about the pylon Camera Software Suite and the pylon Viewer, see Section 3.1 on [page 62](#).

### 7.23.3.4 Timestamp Chunk

The Timestamp chunk feature adds a chunk to each acquired image containing a timestamp that was generated when frame acquisition was triggered.

The timestamp is a 64 bit value. The timestamp is based on a counter that counts the number of "timestamp clock ticks" generated by the camera. The unit for each tick is 1 ns (as specified by the Gev Timestamp Tick Frequency). The counter starts at camera power on, camera reset or at counter reset.

#### To enable the timestamp chunk:

1. Use the Chunk Selector to select the Timestamp chunk.
2. Use the Chunk Enable parameter to set the value of the chunk to true.

Once the Timestamp chunk is enabled and Chunk Mode Active (see Section 7.23.4 on [page 351](#)) is enabled, the camera appends a Timestamp chunk to each acquired image.

After an image with an appended chunk has been received by your computer the chunk must be retrieved. For information about retrieving data chunks, see Section 7.23.5 on [page 352](#).

You can set the Chunk Selector and Chunk Enable parameter value from within your application software by using the Basler pylon API. The following code snippet illustrates using the API to activate the chunk mode, and enable the Timestamp chunk:

```
// make chunk mode active and enable Timestamp chunk
camera.ChunkSelector.SetValue(ChunkSelector_Timestamp);
camera.ChunkEnable.SetValue(true);
```

You can also use the Basler pylon Viewer application to easily set the parameters.

For more information about the pylon Camera Software Suite and the pylon Viewer, see Section 3.1 on [page 62](#).

### 7.23.3.5 Sequencer Set Active Chunk

The Sequencer Set Active chunk feature is available in acA1920-25, acA2040-55, acA2040-120, acA2440-35, acA2440-75, acA3800-14, and acA4600-10 cameras.

The Sequencer Set Active chunk feature adds a chunk to each acquired image. The chunk contains the index number of the sequencer set that was in the active set when the frame start acquisition trigger occurred.

#### To enable the sequencer set active chunk:

1. Make sure the Sequencer feature is enabled.
2. Use the Chunk Selector to select the Sequencer Set Active chunk.
3. Use the Chunk Enable parameter to set the value of the chunk to true.

Once the Sequencer Set Active chunk is enabled and Chunk Mode Active (see Section 7.23.4 on [page 351](#)) is enabled, the camera appends a chunk with the applicable sequencer set index number to each acquired image.

After an image with an appended chunk has been received by your computer the chunk must be retrieved. For information about retrieving data chunks, see Section 7.23.5 on [page 352](#).

You can set the Chunk Selector and Chunk Enable parameter value from within your application software by using the Basler pylon API. The following code snippet illustrates using the API to activate the chunk mode, and enable the Sequencer Set Active chunk:

```
// make chunk mode active and enable Sequencer Set Active chunk
camera.ChunkSelector.SetValue(ChunkSelector_SequencerSetActive);
camera.ChunkEnable.SetValue(true);
```

You can also use the Basler pylon Viewer application to easily set the parameters.

For more information about the pylon Camera Software Suite and the pylon Viewer, see Section 3.1 on [page 62](#).



- The Sequencer Set Active chunk feature is only available when the Sequencer feature is available.
- The Sequencer Set Active chunk feature can only be enabled when the Sequencer feature was enabled.

For more information about the Sequencer feature, see [Section 7.7 on page 221](#)

### 7.23.3.6 Counter Value Chunk

The counter value chunk feature numbers items sequentially as they occur. When the feature is enabled, a chunk is added to each image containing the value of the counter.

The counter value used for the chunk is taken from Counter 1 and relates to Frame Start trigger as the counter event source.

The Counter 1 value is a 32 bit number. The counter starts initially at 1 and increments by 1 for each frame start trigger. The counter counts up to 4294967295 unless it is reset before. After reaching the maximum value or after reset, the counter starts at 0 and then continues counting.

Note: When continuous capture is stopped while the camera is acquiring frame start triggers continuously, several numbers in the counting sequence can be skipped. This happens due to the internal buffering scheme of image data used in the camera.

#### To enable the counter value chunk:

1. Use the chunk selector to select the counter value chunk.
2. Use the Chunk Enable parameter to set the value of the chunk to true.

Once the counter value chunk is enabled and Chunk Mode Active (see Section 7.23.4 on [page 351](#)) is enabled, the camera appends a counter value chunk to each acquired image.

After an image with an appended chunk has been received by your computer the chunk must be retrieved. For information about retrieving data chunks, see Section 7.23.5 on [page 352](#).

You can set the Chunk Selector and Chunk Enable parameter value from within your application software by using the Basler pylon API. The following code snippet illustrates using the API to activate the chunk mode, and enable the counter value chunk:

```
// make chunk mode active and enable Counter Value chunk
camera.ChunkSelector.SetValue(ChunkSelector_CounterValue);
camera.ChunkEnable.SetValue(true);
```

You can also use the Basler pylon Viewer application to easily set the parameters.

For more information about the pylon API and the pylon Viewer, see Section 3.1 on [page 62](#).

## Counter Reset

Whenever the camera is powered off, the counter resets to 0.

During operation, you can reset the counter via the I/O IN line (Line 1), one of the GPIO lines (Line 3, Line 4) if configured for input or via software. You can also disable the ability to perform a reset by setting the counter reset source to off. By default, the counter reset source is set to off.

To use the counter reset feature:

- Set the counter reset source to Line1, Line 3, Line 4, Software, or Off.
- Execute the command if using software as the counter reset source.

You can set the counter reset parameter values from within your application software by using the Basler pylon API. The following code snippets illustrate using the API to configure and set the frame counter reset and to execute a reset via software.

```
// Select counter 1 and assign Frame Start as event source
camera.CounterSelector.SetValue(CounterSelector_Counter1);
camera.CounterEventSource.SetValue(CounterEventSource_FrameStart);

// Select reset by signal applied to input line 1
camera.CounterResetSource.SetValue(CounterResetSource_Line1);

// Select reset by software
camera.CounterResetSource.SetValue(CounterResetSource_Software);

// Execute counter reset
camera.CounterReset.Execute();

// Disable reset
camera.CounterResetSource.SetValue(CounterResetSource_Off);
```

You can also use the Basler pylon Viewer application to easily set the parameters.

For more information about the pylon API and the pylon Viewer, see Section 3.1 on [page 62](#).

For more information about using line 1 as the source signal for a counter reset, see Section 5.7 on [page 74](#) and about using Line 3 and Line 4, see Section 5.9.3 on [page 82](#).

### 7.23.3.7 CRC Checksum Chunk

The CRC (Cyclic Redundancy Check) checksum chunk feature adds a chunk to each acquired image containing a CRC checksum calculated using the X-modem method. As shown in [Figure 115](#), the checksum is calculated using all of the related image data and all of the appended chunks except for the CRC chunk itself. If enabled, the CRC checksum chunk is always the last chunk appended to the image data.

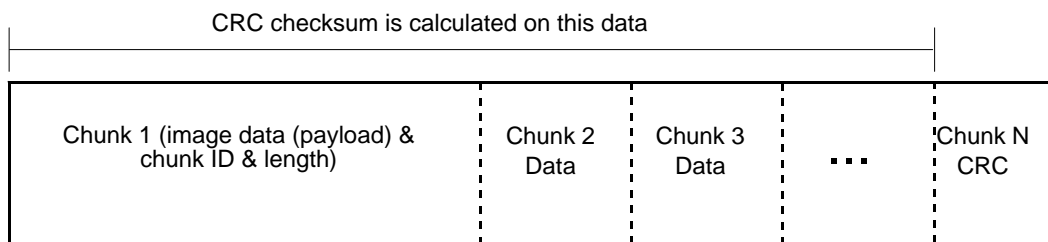

Fig. 115: CRC Checksum

#### To enable the CRC checksum chunk:

1. Use the Chunk Selector to select the CRC checksum chunk.
2. Use the Chunk Enable parameter to set the value of the chunk to true.

Once the CRC checksum chunk is enabled and Chunk Mode Active (see [Section 7.23.4 on page 351](#)) is enabled, the camera appends a CRC checksum chunk to each acquired image.

To retrieve CRC checksum information from a chunk appended to an image that has been received by your PC, the image and its appended chunks must first be parsed. Once the chunk parser has been used, you can retrieve the CRC checksum information.

For more information about retrieving chunk data, see [Section 7.23.5 on page 352](#).

Note that the CRC checksum information provided by the chunk parser is not the CRC checksum itself. Rather it is a true/false result. When the image and appended chunks pass through the parser, the parser calculates a CRC checksum based on the received image and chunk information. It then compares the calculated CRC checksum with the CRC checksum contained in the CRC checksum chunk. If the two match, the result indicates that the image data is OK. If the two do not match, the result indicates that the image is corrupted.

You can set the Chunk Selector and Chunk Enable parameter value from within your application software by using the Basler pylon API. You can also run the parser and retrieve the chunk data. The following code snippets illustrate using the API to activate the chunk mode, enable the CRC checksum chunk, run the parser, and retrieve the CRC checksum chunk data:

```
// Make chunk mode active, select and enable CRC checksum chunk
camera.ChunkSelector.SetValue(ChunkSelector_PayloadCRC16);
camera.ChunkEnable.SetValue(true);
```

You can also use the Basler pylon Viewer application to easily set the parameters.

For more information about the pylon API and the pylon Viewer, see [Section 3.1 on page 62](#).

## 7.23.4 Chunk Mode Active

When Chunk Mode Active is enabled, the camera is in a state where it can generate and append chunk data to image data and transmit them to the computer. This is only done for the chunk features that were previously selected and prepared using the Chunk Selector and Chunk Enable parameters (see Section 7.23.2 on [page 342](#)).

**Note:** Using only the Chunk Selector and Chunk Enable parameters is not sufficient for generating and appending chunk data. To accomplish this, Chunk Mode Active must also be enabled. Disabling Chunk Mode Active prevents chunk data from being appended to image data.



Image data are counted as chunk 1 (for more details, see Section 7.23.5 on [page 352](#)). Despite this, image data (i.e. the data for chunk 1) can be obtained even when Chunk Mode Active is disabled.

### To Enable Chunk Mode Active:

1. Set the Chunk Mode Active parameter to true.

You can set the Chunk Mode Active parameter value from within your application software by using the Basler pylon API. The following code snippet illustrates using the API to set the parameter value:

```
camera.ChunkModeActive.SetValue(true);
```

Also note that when you enable `ChunkModeActive`, the `PayloadType` for the camera changes from `"Pylon::PayloadType_Image"` to `"Pylon::PayloadType_ChunkData"`.

For detailed information about using the pylon API, refer to the Basler pylon Programmer's Guide and API Reference.

You can also use the Basler pylon Viewer application to easily set the parameters.



## 7.23.5 Retrieving Data Chunks

When Chunk Enable and Chunk Mode Active are enabled, the selected data chunks are appended to each acquired image when the image is transferred to the host computer (see Section 7.23.3 on page 343), creating a set of chunks. The set of chunks must be parsed to retrieve the chunk data via a GenICam node map (see below).

The set of chunks includes chunk 1 with the image data ("image data payload") and related supplementary data (chunk ID and length of the image data payload), followed by the selected data chunks, each one consisting of the chunk payload and supplementary data.

The PayloadSize parameter value **for the device** (i.e. for the camera) indicates the calculated **maximum** size ("maximum buffer size") that can be expected to occur for a set of chunks. The calculated maximum size is derived from the current camera parameter settings (ROI size, pixel format, selected data chunks, etc.).

|   |   |
|---|---|
|  | <p>Make sure all camera parameters are set as desired before reading the PayloadSize parameter value.</p> |
|---|---|

The **actual** size of a set of chunks as received by the computer ("grab result") can be read from the PayloadSize value **for the grab result**. The actual size will be equal to or smaller than the calculated maximum size.

A set of chunks (chunks one through N) is illustrated in Figure 116. The example assumes that the CRC Checksum chunk was enabled.

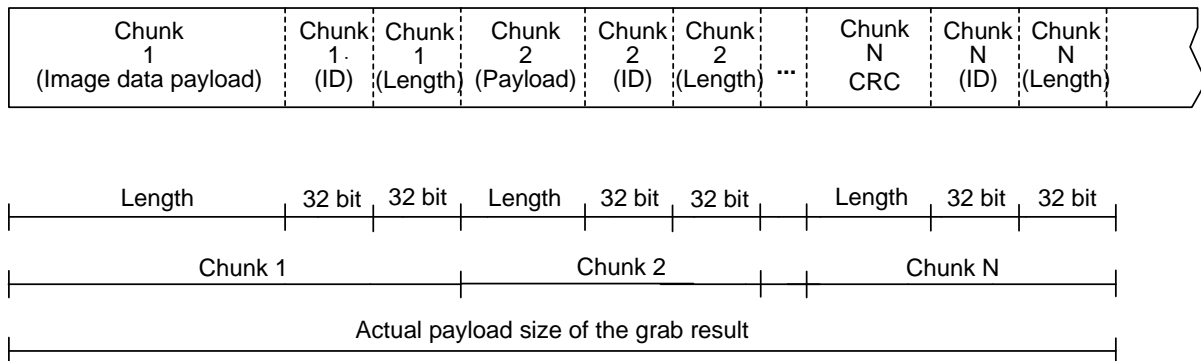

Fig. 116: Example of a Set of Chunks Related to One Image Acquisition

## Parsing the Appended Chunks

After the image data chunk and appended chunks were transferred to the computer, the sequence of chunks must be parsed to retrieve the chunk data via a GenICam node map.

- If you use code written in C++ the appended data chunks are parsed automatically after the image data were written into the computer's memory. For each set of chunks, the decoding starts from the end of the last data chunk. The chunk data can be accessed using the chunk data node map.

For more information about accessing chunk data, see the documentation for the C++ API in the *Basler pylon Programmer's Guide and API Reference* for C++ and the included "Grab\_ChunkImage" code sample.

- If you use code written in C or C# you must run the image data chunk and the appended chunks through the chunk parser that is included in the C API for Basler pylon software and via the device node map.

For more information about accessing chunk data, see the documentation for the C or C# API in the *Basler pylon Programmer's Guide and API Reference* for C or C#, respectively.

# 8 Troubleshooting and Support

This chapter outlines the resources available to you, if you need help working with your camera.

## 8.1 Tech Support Resources

If you need advice about your camera or if you need assistance troubleshooting a problem with your camera, you can contact the Basler technical support team for your area. Basler technical support contact information is located in the front pages of this manual.

You will also find helpful information such as frequently asked questions, downloads, and application notes in the Support and Downloads sections of our website:

[www.baslerweb.com](http://www.baslerweb.com)

If you do decide to contact Basler technical support, please take a look at Section 8.3 on [page 355](#) before you call. The section gives information about assembling relevant data that will help the Basler technical support team to help you with your problem.

## 8.2 Obtaining an RMA Number

Whenever you want to return material to Basler, you must request a Return Material Authorization (RMA) number before sending it back. The RMA number **must** be stated in your delivery documents when you ship your material to us! Please be aware that, if you return material without an RMA number, we reserve the right to reject the material.

You can find detailed information about how to obtain an RMA number in the Support section of our website: [www.baslerweb.com](http://www.baslerweb.com)

## 8.3 Before Contacting Basler Technical Support

To help you as quickly and efficiently as possible when you have a problem with a Basler camera, it is important that you collect several pieces of information before you contact Basler technical support. Basler technical support contact information is shown in the title section of this manual.

Three different methods are available of providing data to Basler technical support. The methods complement each other. We therefore recommend using them all for optimum assistance:

- by automatically generating support information using the Basler pylon USB Configurator . A report is generated with information about the USB device tree displayed in the device pane and detailed information about each device.
- by sending an email to Basler technical support, already partially prepared by the Basler pylon USB Configurator
- by using the form given below.

### To automatically generate support information:

1. Click the question mark ? in the menu bar of the Basler pylon USB Configurator.
2. Click **Generate Support Information...** in the dropdown menu.  
The **Support Information** window opens displaying a report.
3. Click the **Copy to Clipboard** button to keep the support information for inclusion in an email to Basler technical support.

### To use a prepared email:

1. Click the question mark ? in the menu bar of the Basler pylon USB Configurator.
2. Click **Contact Basler Support...** in the dropdown menu.  
A **pylon Support Request** window for an email to Basler technical support opens. It includes information about the currently used versions of pylon and the computer's operating system.
3. Include the previously generated support information (see above).
4. If you are outside Europe replace **support.europe@baslerweb.com** by the address of your local Basler technical support.

### To use the form:

1. Copy the form that appears below, fill it out, and send it - with sample images if appropriate - with your email to Basler technical support  
or  
fax the completed form with the requested files attached to your local dealer or to Basler technical support.

1 The camera's product ID: \_\_\_\_\_

2 The camera's serial number: \_\_\_\_\_

3 Host adapter and chipset that you use with the camera: \_\_\_\_\_

Do you use a hub?

Yes

No

4 Describe the problem in as much detail as possible:  
(If you need more space, use an extra sheet of paper.)  
\_\_\_\_\_  
\_\_\_\_\_  
\_\_\_\_\_

5 If known, what's the cause of the problem?  
\_\_\_\_\_  
\_\_\_\_\_  
\_\_\_\_\_

6 When did the problem occur?  After start.  While running.  
 After a certain action (e.g., a change of parameters):  
\_\_\_\_\_  
\_\_\_\_\_  
  
\_\_\_\_\_  
\_\_\_\_\_

7 How often did/does the problem occur?  Once.  Every time.  
 Regularly when:  
\_\_\_\_\_  
 Occasionally when:  
\_\_\_\_\_  
\_\_\_\_\_  
\_\_\_\_\_  
\_\_\_\_\_

- 8 How severe is the problem?
- Camera can still be used.
  - Camera can be used after I take this action:  
 \_\_\_\_\_  
 \_\_\_\_\_
  - Camera can no longer be used.

- 9 Did your application ever run without problems?  Yes  No

10 Parameter set

It is very important for Basler technical support to get a copy of the exact camera parameters that you were using when the problem occurred.

To make note of the parameters, use the Basler pylon Viewer.

If you cannot access the camera, please try to state the following parameter settings:

- Image Size (ROI): \_\_\_\_\_
- Pixel Format: \_\_\_\_\_
- Exposure Time: \_\_\_\_\_
- Frame Rate: \_\_\_\_\_

11 Live image/test image

If you are having an image problem, try to generate and save live images that show the problem. Also generate and save test images. Please save the images in BMP format, zip them, and send them to Basler technical support.

## Revision History

| Doc. ID Number | Date        | Changes   |
|----------------|-------------|---|
| AW00123401000  | 04 Jun 2013 | Initial release of the document. Applies to prototypes only.  |
| AW00123402000  | 16 Apr 2014 | <p>First release of this document for series cameras and some prototype cameras.</p> <p>Updated Asian contact information.</p> <p>Updated names throughout the manual related to the release of the Basler pylon 4 Camera Software Suite.</p> <p>Included information throughout the document about the following cameras:</p> <ul style="list-style-type: none"> <li>■ acA640-90um/uc, acA1920-25um/uc (series cameras)</li> <li>■ acA2000um/umNIR/uc, acA2040-80um/umNIR/uc, acA3800-14um/uc, and acA4600-10uc (prototype cameras).</li> </ul> <p>Replaced "pixel data format" by "pixel format" throughout the document.</p> <p>Replaced "pixel size" by "pixel edge length" in Section 1.2 on <a href="#">page 2</a>.</p> <p>Added information about the CS-mount in Section 1.2 on <a href="#">page 2</a>.</p> <p>Added "Mounting Instructions" as Section 1.5 on <a href="#">page 41</a>,</p> <p>Updated the LZ4 license text in Section 1.7 on <a href="#">page 44</a>.</p> <p>Modified Section 1.9.2 on <a href="#">page 46</a> to better avoid EMI problems.</p> <p>Expanded the precautions about avoiding dust on the sensor, about using the correct plug, and about cleaning properly in Section 1.10 on <a href="#">page 47</a>.</p> <p>Added a reference to the "Recommended Components for Basler USB 3.0 Cameras" document in Section 2 on <a href="#">page 43</a>.</p> <p>Added a reference to cable documentation in Section 5.5 on <a href="#">page 56</a>.</p> <p>Added the following sections:</p> <ul style="list-style-type: none"> <li>■ Section 5.10 on <a href="#">page 71</a></li> <li>■ Section 5.11.2 on <a href="#">page 79</a></li> <li>■ Section 5.12 on <a href="#">page 82</a></li> <li>■ Section 5.13 on <a href="#">page 92</a></li> <li>■ Section 6 on <a href="#">page 99</a></li> <li>■ Section 7 on <a href="#">page 179</a></li> <li>■ Section 8 on <a href="#">page 197</a></li> </ul> <p>Described how to use the Basler pylon USB Configurator for contacting Basler technical support in Section 9.3 on <a href="#">page 308</a>.</p> |
| AW00123403000  | 05 Sep 2014 | Internal release.   |
| AW00123404000  | 17 Jun 2015 | <p>Minor additions and corrections throughout the manual relating to former prototype cameras.</p> <p>Added information for former prototype cameras: acA2000-165, acA2040-90, acA3800-14 and acA4600-10 throughout the manual.</p> <p>Added new prototype cameras: acA645-100um/uc, acA1920-155um/uc.</p> <p>Replaced "lens adapter" by "lens mount" and "cylindric housing extension" throughout the manual.</p> <p>Added precautions related to SELV/LPS requirements for power supplies in Section 1 on <a href="#">page 1</a> and Section 5 on <a href="#">page 53</a>.</p>  |

| Doc. ID Number | Date | Changes  |
|----------------|------|--|
|                |      | <p>cont'd</p> <p>Removed pixel formats RGB 8 and BGR 8 from Table 7 on <a href="#">page 12</a>.</p> <p>Modified the sensor size for the acA1600-20um in Section 1.2 on <a href="#">page 2</a>.</p> <p>Removed the availability of CS-mounts for acA1920-20um/uc cameras in Section 1.2 on <a href="#">page 2</a> and added a related note in Section 1.4.1 on <a href="#">page 36</a>.</p> <p>Indicated UL certification for cameras in Section 1.2 on <a href="#">page 2</a>.</p> <p>Added a note about the availability of CE conformity declarations to the tables in Section 1.2 on <a href="#">page 2</a>.</p> <p>Added information about the availability of pylon for Linux in Section 1.2 on <a href="#">page 2</a>.</p> <p>Added information about mechanical stress tests in Section 1.6 on <a href="#">page 43</a>.</p> <p>Added max. ambient temperature (UL 60950-1) in Section 1.9.1 on <a href="#">page 46</a>.</p> <p>Added information in Section 2 on <a href="#">page 43</a> and Section 6.10 on <a href="#">page 167</a> about restricted initial maximum allowed acquisition frame rates for acA2000-165u and acA2040-90u cameras.</p> <p>Added an explanation about the pylon Viewer's significance for the camera configuration mechanism in Section 3.1.1 on <a href="#">page 46</a></p> <p>Modified the descriptions of voltage requirements in Section 5.7.1 on <a href="#">page 59</a>, Section 5.8.1 on <a href="#">page 62</a>, Section 5.9.2 on <a href="#">page 67</a>, and Section 5.9.3 on <a href="#">page 69</a>.</p> <p>Added a note about the occurrence of a frame acquisition when enabling or disabling the inverter in Section 5.11.3 on <a href="#">page 81</a> and Section 5.12.5 on <a href="#">page 89</a>.</p> <p>Added a note in Section 5.12.6.1 on <a href="#">page 90</a> about the triggering of Timer 1 in the absence of a flash window start signal.</p> <p>Revised Section 5.13 on <a href="#">page 92</a>.</p> <p>Added trigger sources for the frame start trigger in Section 6.4.1.2 on <a href="#">page 115</a>.</p> <p>Added in Section 6.6.2 on <a href="#">page 134</a> a note about the unavailability of the flash window signal in ERS mode when very short exposure times are used.</p> <p>Updated the maximum allowed gain settings for acA3800-14u and acA4600-10u cameras in Table 36 on <a href="#">page 198</a>.</p> <p>Added Section 8.6 on <a href="#">page 216</a> describing the sequencer feature.</p> <p>Added a section about the effective image ROI in Section 8.7.4 on <a href="#">page 249</a>.</p> <p>Added a note about the unavailability of vertical and horizontal binning by 3 for acA3800-14um cameras in Section 8.7.1 on <a href="#">page 245</a>.</p> <p>Added a note about checking ROI settings when changing a binning parameter value in Section 8.7.4 on <a href="#">page 249</a>.</p> <p>Highlighted the distinction between "active set" and "active user set" in Section 8.17 on <a href="#">page 290</a>.</p> <p>Added the Line Status All chunk as Section 8.18.3.2 on <a href="#">page 299</a>.</p> |



| Doc. ID Number | Date        | Changes   |
|----------------|-------------|---|
| AW00123405000  | 18 Dec 2015 | <p>Minor changes and corrections throughout the manual.</p> <p>Added information for the following new cameras: acA640-750u, acA800-510u, acA1300-200u, acA1920-40u, acA1920-150u, 1920-155u, and acA2500-60u throughout the manual.</p> <p>Indicated the housing temperature measuring point in Section 1.10.2 on <a href="#">page 52</a>.</p> <p>Allotted camera specifications and spectral response curves to different sections, according to sensor technology (CCD, CMOS) in Section 1.2 on <a href="#">page 2</a> and Section 1.3 on <a href="#">page 22</a>.</p> <p>Included information about changed effective Bayer filter alignment with mirror images in Section 1.2 on <a href="#">page 2</a>, Section 7.1.2 on <a href="#">page 195</a>, and Section 7.11 on <a href="#">page 265</a></p> <p>Added the "Over Temperature Behavior" Chapter 1.10.3 on <a href="#">page 52</a>.</p> <p>Re-phrased Chapter 3 on <a href="#">page 62</a>.</p> <p>Removed the reference to DG001115 in Section 2 on <a href="#">page 60</a>.</p> <p>Added a note in Section 6.6.2.3 on <a href="#">page 157</a> about the unavailability of the flash window signal in ERS mode when very short exposure times are used.</p> <p>Modified Section 6.8.1 on <a href="#">page 167</a> to distinguish between involvement of opto-isolated and GPIO lines.</p> <p>Indicated the logical meanings of ExpAc levels in Section 6.8.1 on <a href="#">page 167</a>. Corrected info box in Section 6.8.1 on <a href="#">page 167</a>: The acA1920-25 and acA2500-14 cameras are no longer listed as lacking the exposure active signal.</p> <p>Included information about removing artificial color shift in Section 7.3.1 on <a href="#">page 198</a>.</p> <p>Replaced AOI by ROI in code snippets in Section 7.15 on <a href="#">page 299</a>.</p> <p>Added the "Pattern Removal" Section 7.15.8 on <a href="#">page 314</a>.</p> <p>Added information in Section 7.18 on <a href="#">page 322</a> about operation with 10 bit output and indicated activation of test image 2 by over temperature mode.</p> |
| AW00123406000  | 21 Dec 2015 | Removed information about the acA645-100um/uc throughout the manual.  |

| Doc. ID Number | Date        | Changes  |
|----------------|-------------|--|
| AW00123407000  | 21 May 2016 | <p>Removed prototype status for the acA1920-150 and acA2500-60 cameras.</p> <p>Changed "Subpart J" to "Subpart B" on the second page.</p> <p>Removed the notes throughout the manual, that indicated the unavailability of the digital shift, sequencer, and mirror features and of test image reset and hold for acA1920-40u and acA1920-155u cameras.</p> <p>Transferred the "Color Creation and Enhancement" chapter into <a href="#">Chapter 7</a>.</p> <p>Added pixel formats (Mono 8, RGB 8, BGR 8, YCbCr422_8) to the specifications for color cameras (acA640-750, acA800-510, acA1300-200, acA1920-40, acA1920-150, acA1920-155, acA2500-60) in Section 1.3.2 on <a href="#">page 7</a>.</p> <p>Updated camera power requirements differentiating between mono and color cameras in Section 1.3.2 on <a href="#">page 7</a> for these cameras: acA640-750, acA800-510, acA1300-200, acA1920-40, acA1920--150, acA1920-155, and acA2500-60.</p> <p>Updated and modified Section 1.10.3 on <a href="#">page 52</a>.</p> <p>Added precautions calling for continuous camera operation in Section 1.11 on <a href="#">page 56</a></p> <p>Updated version PFNC version number in Section 1.3 on <a href="#">page 3</a> and Section 7.14.1.2 on <a href="#">page 280</a>.</p> <p>Removed exposure time control via hardware trigger signal (trigger width exposure) for cameras with Aptina sensor (acA1920-25, acA2500-14, acA3800-14, acA4600-10) in Section 1.3.2 on <a href="#">page 7</a>.</p> <p>Corrected camera event names in Table 6.8.5 on <a href="#">page 179</a>.</p> <p>Added Mono formats to Table 38 on <a href="#">page 195</a>.</p> <p>Updated exposure time offsets for the acA1920-40, acA1920-150, acA1920-155, and acA2500--60 cameras in Section 6.4.3.2 on <a href="#">page 136</a>.</p> <p>Removed the information from Section 6.4.3.2 on <a href="#">page 136</a> about the acA1920-155 not supporting trigger width exposure.</p> <p>Updated minimum allowed exposure times for the acA1920--150 and acA2500--60 cameras in Section 6.5.1 on <a href="#">page 146</a>.</p> <p>Removed availability of the fast readout mode for the acA1920-155 and acA1920-40 cameras in Section 6.6.1.1 on <a href="#">page 150</a>.</p> <p>Made terminology compatible in Section 6.6.2 on <a href="#">page 151</a> through Section 6.8.2 on <a href="#">page 169</a> with terminology as apparent from the pylon viewer.</p> <p>Re-arranged table entries from <a href="#">Table 35</a> through <a href="#">Table 39</a>.</p> <p>Corrected camera event names in Table 6.8.5 on <a href="#">page 179</a>.</p> <p>Added Mono formats to Table 38 on <a href="#">page 195</a>.</p> <p>Added the "PGI Feature Set" Section 7.3.2 on <a href="#">page 201</a>.</p> |

| Doc. ID Number | Date        | Changes   |
|----------------|-------------|---|
| AW00123407000  | 21 May 2016 | <p>cont'd</p> <p>Added Section 7.2.1 on <a href="#">page 198</a> to explain analog and digital GainAll control.</p> <p>Indicated conditions in Section 7.7.2.1 on <a href="#">page 223</a> for including LUTEnable in sequencer operation.</p> <p>Indicated different trigger source availabilities of trigger sources for sequencer paths 0 and 1 in Section 7.7.2.2 on <a href="#">page 224</a>.</p> <p>Changed parameter name "Device ID" to "Device Serial Number" in Section 7.19 on <a href="#">page 327</a>.</p>   |
| AW00123408000  | 06 Jul 2016 | <p>Added information for the following new cameras: acA2040-55u, acA2040-120u, acA2440-35u, and acA2440-75u throughout the manual.</p> <p>Updated the max. frame rates for acA1920-150u and acA2500-60u cameras in Section 1.3.2 on <a href="#">page 7</a>.</p> <p>Added Section 5.9.2 on <a href="#">page 81</a> about setting the line mode for a GPIO line.</p> <p>Modified the exposure time offset values for acA1920-40u and acA2040-90u cameras in Section 6.4.3.2 on <a href="#">page 136</a>.</p> <p>Added a section about RGB8 and BRG8 in Section 7.14.1.2 on <a href="#">page 280</a>.</p> <p>Added the frame start wait and frame burst start wait events in Section 6.8.5 on <a href="#">page 179</a> and Section 7.17 on <a href="#">page 319</a>.</p> <p>Added the Color Raw user set in Section 7.21 on <a href="#">page 331</a>.</p> <p>Rearranged information in Section 7.23 on <a href="#">page 342</a>.</p> |

# Index

## Numerics

|                       |    |
|-----------------------|----|
| 6-pin connector ..... | 68 |
| pin assignment.....   | 69 |
| pin numbering .....   | 69 |

## A

|                                 |     |
|---------------------------------|-----|
| acquisition                     |     |
| monitoring .....                | 167 |
| status .....                    | 171 |
| timing chart .....              | 180 |
| acquisition mode                |     |
| continuous.....                 | 113 |
| single frame .....              | 113 |
| Acquisition Start command ..... | 113 |
| Acquisition Stop command .....  | 114 |
| active set.....                 | 222 |
| additive mixing .....           | 291 |
| Auto functions                  |     |
| balance white auto .....        | 313 |
| exposure auto .....             | 309 |
| gain auto .....                 | 307 |
| general.....                    | 299 |
| pattern removal.....            | 314 |
| profile .....                   | 312 |
| averaging .....                 | 252 |

## B

|                                   |     |
|-----------------------------------|-----|
| balance ratio .....               | 284 |
| balance white .....               | 313 |
| automatic adjustment.....         | 313 |
| balance ratio .....               | 284 |
| manual adjustment.....            | 284 |
| Bayer filter                      |     |
| alignment (effective).....        | 278 |
| alignment (physical).....         | 278 |
| explained.....                    | 277 |
| binning                           |     |
| color cameras .....               | 253 |
| decreased resolution.....         | 256 |
| effect on image ROI settings..... | 256 |
| horizontal .....                  | 251 |
| image distortion.....             | 257 |
| monochrome cameras .....          | 250 |
| response to light.....            | 256 |
| vertical.....                     | 250 |

|                               |        |
|-------------------------------|--------|
| binning mode .....            | 252    |
| averaging.....                | 252    |
| summing.....                  | 252    |
| black level.....              | 203    |
| block diagram .....           | 65, 67 |
| boundary parameter value..... | 198    |

## C

|                                 |                         |
|---------------------------------|-------------------------|
| camera                          |                         |
| dimensions .....                | 41                      |
| models.....                     | 1                       |
| mounting.....                   | 46                      |
| power.....                      | 73                      |
| CCD sensor .....                | 64                      |
| chunk                           |                         |
| counter value chunk .....       | 348                     |
| CRC checksum chunk.....         | 350                     |
| exposure time chunk .....       | 345                     |
| gain chunk .....                | 343                     |
| line status all chunk .....     | 344                     |
| retrieving.....                 | 352                     |
| sequencer set active chunk..... | 347                     |
| timestamp chunk .....           | 346                     |
| chunk enable .....              | 342                     |
| chunk features .....            | 342                     |
| chunk mode active.....          | 342                     |
| chunk selector .....            | 342                     |
| CMOS sensor .....               | 66                      |
| C-mount.....                    | 41, 42                  |
| color                           |                         |
| additive mixing.....            | 291                     |
| adjustment.....                 | 289, 290, 293, 294, 298 |
| parameters .....                | 294                     |
| creation.....                   | 277                     |
| cube.....                       | 291, 292                |
| enhancement.....                | 283, 295, 297, 298      |
| fidelity .....                  | 297                     |
| filter alignment .....          | 266, 278                |
| hexagon.....                    | 291, 293, 298           |
| primary .....                   | 290, 291, 293           |
| secondary .....                 | 290, 291, 293           |
| space .....                     | 275, 290, 291           |
| RGB .....                       | 283                     |
| temperature .....               | 289                     |
| transformation .....            | 284, 289, 295, 296      |

- color interpolation
  - see demosaicing
- color transformation
  - RGB to RGB.....283
- conformity.....4
- counter value chunk .....348
- CRC checksum chunk.....350
- critical temperature
  - event .....52
- CS-mount .....41, 43
  
- D**
- data chunk
  - see chunk
- debouncer .....94
- decimation
  - horizontal.....261
  - setting.....261
  - vertical.....258
- demosaicing
  - 2x2
  - 5x5
  - Basler PGI.....286
  - mode .....288
  - simple.....286
- demosaicing mode
  - Basler PGI
  - simple
- device information parameters .....327
- device temperature.....52, 55
- digital shift .....207
- dimensions
  - see camera dimensions
- direct-coupled (GPIO) input.....82
- direct-coupled (GPIO) output .....84
- direct-coupled I/O lines.....80
  
- E**
- effective sensor diagonal.....3
- electromagnetic interference .....50
- electronic shutter
  - global.....148
  - rolling.....151
- electrostatic discharge.....50
- EMI .....50
- environmental requirements.....51
- ESD .....50
  
- event
  - critical temperature ..... 321
  - exposure end..... 321
  - frame burst start ..... 321
  - frame burst start overtrigger ..... 321
  - frame start ..... 321
  - frame start overtrigger ..... 321
  - frame start wait ..... 321
  - over temperature ..... 321
- event notification ..... 319
- exposure active..... 154
- exposure mode
  - timed ..... 116, 136
  - trigger width ..... 116, 137
- exposure overlap time mode ..... 142
- exposure time chunk..... 345
- exposure time offset ..... 138
- ExposureTime parameter ..... 145
  
- F**
- filter alignment ..... 266, 278
- filter holder ..... 44
- flash window ..... 157
- frame..... 113
- frame burst start trigger ..... 114
- frame rate
  - increasing ..... 186
  - maximum allowed..... 184
- frame rate calculator ..... 184
- frame start trigger ..... 114
  
- G**
- gain ..... 198
  - mechanisms of control..... 198
- gain chunk ..... 343
- gamma correction ..... 275
- GPIO lines ..... 80
  
- H**
- heat dissipation..... 51, 52
- housing temperature
  - during operation..... 51
  - during storage..... 51
  - measuring spot ..... 51

**I**

|   |     |
|---|-----|
| I/O                                     |     |
| cable .....                             | 71  |
| I/O line status .....                   | 107 |
| image quality .....                     | 52  |
| input                                   |     |
| direct-coupled (GPIO) .....             | 82  |
| opto-isolated .....                     | 74  |
| input line                              |     |
| configuration .....                     | 93  |
| debouncer .....                         | 94  |
| inverter .....                          | 96  |
| internal temperature (core board) ..... | 52  |
| IR cut filter .....                     | 44  |
| cut off .....                           | 34  |
| transmission .....                      | 34  |
| IR-cut filter .....                     | 282 |

**L**

|   |        |
|---|--------|
| LED indicator .....                       | 68, 70 |
| lens mount                                |        |
| C-mount .....                             | 41, 42 |
| CS-mount .....                            | 41, 43 |
| lens thread length (maximum allowed) .... | 44     |
| licensing                                 |        |
| LZ4 .....                                 | 49     |
| light source                              |        |
| color temperature .....                   | 289    |
| Daylight 5000 K .....                     | 289    |
| Daylight 6500 K .....                     | 289    |
| Off .....                                 | 289    |
| preset .....                              | 289    |
| Tungsten 2800 K .....                     | 289    |
| light source preset .....                 | 289    |
| line mode .....                           | 81     |
| line pitch .....                          | 338    |
| line status all chunk .....               | 344    |
| LPS                                       |        |
| see power supply .....                    | 56     |
| luminance lookup table .....              | 271    |
| LUT .....                                 | 271    |

**M**

|                               |     |
|-------------------------------|-----|
| mechanical stress tests ..... | 48  |
| mirror image .....            | 265 |
| mode                          |     |
| acquisition .....             | 113 |
| binning .....                 | 252 |

|                             |               |
|-----------------------------|---------------|
| demosaicing .....           | 288           |
| exposure .....              | 116, 136, 137 |
| exposure overlap time ..... | 142           |
| line .....                  | 81            |
| over temperature .....      | 52, 222       |
| sensor readout .....        | 150           |
| shutter .....               | 151           |
| trigger .....               | 114           |

## mount

  see lens mount

|                             |    |
|-----------------------------|----|
| mounting instructions ..... | 46 |
| mounting points .....       | 41 |
| mounting screw holes .....  | 41 |

**N**

|                       |     |
|-----------------------|-----|
| noise reduction ..... | 286 |
|-----------------------|-----|

**O**

|                             |         |
|-----------------------------|---------|
| optical format              |         |
| see optical size            |         |
| optical size .....          | 3       |
| opto-isolated input .....   | 74      |
| opto-isolated output .....  | 77      |
| output                      |         |
| direct-coupled (GPIO) ..... | 84      |
| opto-isolated .....         | 77      |
| output line                 |         |
| configuration .....         | 97      |
| inverter .....              | 104     |
| timer .....                 | 105     |
| output signal               |         |
| exposure active .....       | 154     |
| over temperature            |         |
| behavior .....              | 52      |
| event .....                 | 52      |
| mode .....                  | 52, 222 |
| overheating .....           | 52      |

**P**

|  |               |
|--|---------------|
| pattern removal .....                  | 314           |
| PGI feature set .....                  | 286, 298      |
| pin assignment (6-pin connector) ..... | 69            |
| pin numbering (6-pin connector) .....  | 69            |
| pixel format .....                     | 3             |
| primary color .....                    | 290, 291, 293 |
| propagation delays .....               | 86            |
| pulse width (minimum) .....            | 97            |

**R**

|                                |     |
|--------------------------------|-----|
| readout mode .....             | 150 |
| see sensor readout mode        |     |
| region of interest (ROI) ..... | 213 |
| remove parameter limits .....  | 206 |
| RMA number .....               | 354 |

**S**

|                                  |               |
|----------------------------------|---------------|
| scaling .....                    | 263           |
| secondary color .....            | 290, 291, 293 |
| SELV                             |               |
| see power supply                 |               |
| sensor architecture              |               |
| CCD .....                        | 65            |
| CMOS .....                       | 67            |
| sensor readout .....             | 150           |
| sensor readout mode              |               |
| fast .....                       | 150           |
| normal .....                     | 150           |
| sequencer .....                  | 221           |
| sequencer set active chunk ..... | 347           |
| set of chunks .....              | 352           |
| sharpness enhancement .....      | 286           |
| shutter mode                     |               |
| global reset release .....       | 151, 154      |
| rolling .....                    | 151           |
| spectral response                |               |
| color cameras .....              | 34            |
| mono cameras .....               | 27            |
| storage                          |               |
| humidity .....                   | 51            |
| temperature .....                | 51            |
| summing .....                    | 252           |

**T**

|                             |          |
|-----------------------------|----------|
| technical support .....     | 354      |
| temperature                 |          |
| device .....                | 52, 55   |
| housing .....               | 51       |
| internal (core board) ..... | 52       |
| storage .....               | 51       |
| temperature state .....     | 52, 55   |
| test images .....           | 322      |
| tightening sequence .....   | 46, 47   |
| timed exposure mode .....   | 116, 136 |
| timestamp chunk .....       | 346      |
| timestamp value .....       | 318      |

## trigger

|                                   |          |
|-----------------------------------|----------|
| frame burst start .....           | 114      |
| frame start .....                 | 114      |
| source .....                      | 116      |
| trigger mode .....                | 114      |
| trigger width exposure mode ..... | 116, 137 |

**U**

|                            |     |
|----------------------------|-----|
| USB 3.0                    |     |
| cable .....                | 71  |
| USB 3.0 Micro-B port ..... | 68  |
| USB 3.0 powered hub        |     |
| LPS .....                  | 56  |
| SELV .....                 | 56  |
| use cases                  |     |
| sequencer operation .....  | 236 |
| triggering .....           | 187 |
| user defined values .....  | 330 |
| user set .....             | 331 |
| active .....               | 331 |
| auto functions .....       | 332 |
| color raw .....            | 332 |
| configuring .....          | 331 |
| default .....              | 332 |
| high gain .....            | 332 |
| loading .....              | 335 |
| saving .....               | 334 |
| selecting .....            | 333 |
| user set default .....     | 332 |

**V**

|                      |     |
|----------------------|-----|
| virtual sensor ..... | 256 |
|----------------------|-----|

**W**

|                   |  |
|-------------------|--|
| white balance     |  |
| see balance white |  |