



smart
vision lights

ODSW75 Brick Light

SPOT LIGHT

OVERDRIVE™ | WASHDOWN

P R O D U C T D A T A S H E E T



Warranty
10
YEAR

Compliant
IEC
62471

Compliant
CE
RoHS

Rated
IP
68K

Connector
5-PIN
M12

PRODUCT HIGHLIGHTS

- ✓ OverDrive™ — Up to five times brighter than a standard Brick Light
- ✓ Stainless-steel 316 housing
- ✓ Built-in driver
- ✓ PNP and NPN trigger signal input
- ✓ Maximum 5000 strobes per second





PRODUCT INTRODUCTION

The ODSW75 Brick Light Series features a 316 stainless-steel IP68K-rated enclosure specially designed for food industry and washdown environments where water and harsh detergents are present. NPN or PNP trigger signals can be used to control the pulse of the light. Intensity of the light can be controlled via 1–10VDC analog signal line or by adjusting the built-in manual potentiometer.



PRODUCT SPECIFICATIONS

Electrical Input	24VDC +/-5%
Input Current	Max. 2.5 A draw during strobe Max Average 250 mA
Wattage	Max. 96 W during strobe Max. Avg. 9.6 W
Strobe Input	PNP: +4VDC or greater to activate NPN: GND (< 1VDC) to activate
PNP Line	4 mA @ 4VDC 10 mA @ 12VDC 20 mA @ 24VDC
NPN Line	15 mA @ Common (0VDC)
Duty Cycle	Max. 10%
Strobe/Pulse Time	Max 5000 SPS (strokes per second) Max. Single Pulse = 125 ms (see SafeStrobe™ Technology for more information)
Potentiometer	270° turn pot — intensity control of 10%–100%. Turn clockwise to increases intensity.
Analog Intensity	The output is adjustable from 10%–100% of brightness by a 1–10VDC analog signal.
Connection	5-pin M12 connector
Ambient Temperature	-18°–40°C (0°–104°F)
IP Rating	IP68K
Weight	~710 g
Compliances	CE, RoHS, IEC 62471
Warranty	10 years. For complete warranty information, visit smartvisionlights.com/warranty .



WIRING CONFIGURATION

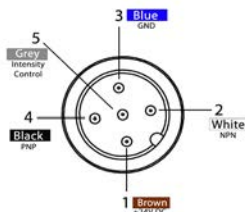

Pin layout for light (Male Connector)

Pin	Function	Signal	Wire Color
1	Power In	+24VDC	BROWN
2	NPN	Sinking Signal	WHITE
3	GND	Ground	BLUE
4	PNP	Sourcing Signal	BLACK
5	Intensity Control	1–10VDC	GREY*

* Some cables use green/yellow for pin 5

For maximum intensity, tie pin 5 to pin 1 at +24VDC.

For continuous mode: Tie PNP (pin 4) can be tied to +24VDC (pin 1) or tie NPN (pin 2) can be tied to Ground (pin 3).

OPTIONAL

For maximum intensity, connect pin 5 to pin 1 at 24VDC.
Potentiometer intensity needs to be set to 100%.



RESOURCE CORNER

Additional resources, including CAD files, videos, and application examples, are available on our website.



LIGHT PATTERNS

Smart Vision Lights recommends that the ODSW75 be used at a working distance between 300 mm and 4000 mm.

Beam Diameter (White Light) — 5700K

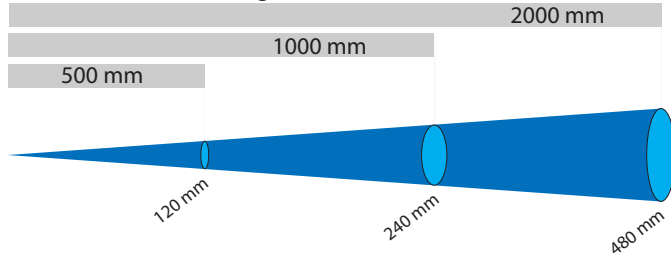

Beam Diameter (White Light) — 5700K

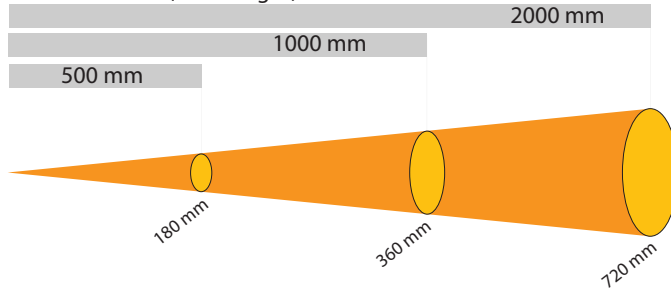

Beam Diameter (White Light) — 5700K

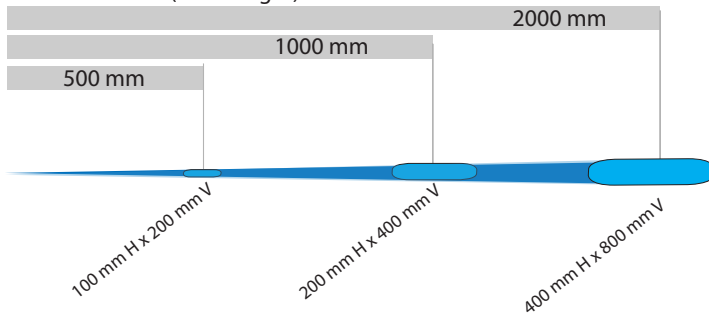

LIGHTING PATTERN FOR THE ODSW75 with Narrow (Standard) Lenses

Working Distance mm (inches)	Pattern (80%–100% measured intensity) mm (inches)
500 mm (19.7")	120 mm (~4.7") D
1000 mm (39.4")	240 mm (~9.4") D
2000 mm (78.8")	480 mm (~18.9") D

Typical Output Performance	Illuminance (Lux)
Distance = 500 mm	38,000
<i>Illuminance measurement taken on White Lights — 5700K</i>	

LIGHTING PATTERN FOR THE ODSW75 with Wide (W) Lenses

Working Distance mm (inches)	Pattern (80%–100% measured intensity) mm (inches)
500 mm (19.7")	180 mm (~7") D
1000 mm (39.4")	360 mm (~14.2") D
2000 mm (78.8")	720 mm (~28.3") D

Typical Output Performance	Illuminance (Lux)
Distance = 500 mm	32,500
<i>Illuminance measurement taken on White Lights — 5700K</i>	

LIGHTING PATTERN FOR THE ODSW75 with Line (L) Lenses

Working Distance mm (inches)	Pattern (80%–100% measured intensity) mm (inches)
500 mm (19.7")	100 mm (~3.9") H x 200 mm (~7.8") V
1000 mm (39.4")	200 mm (~7.8") H x 400 mm (~15.7") V
2000 mm (78.8")	400 mm (~15.7") H x 800 mm (~31.5") V

Typical Output Performance	Illuminance (Lux)
Distance = 500 mm	49,000
<i>Illuminance measurement taken on White Lights — 5700K</i>	

The ODSW75 Brick Light produces a uniform light pattern.

Working Distance = 500 mm Grid set to 25 mm x 25 mm

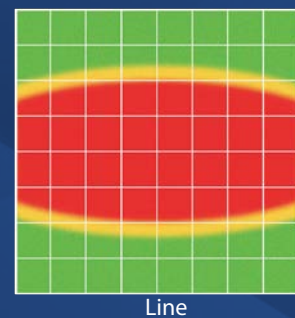
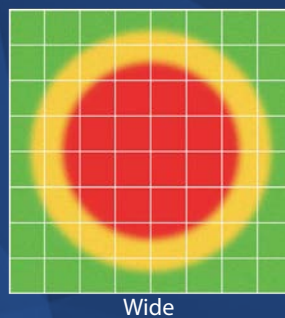
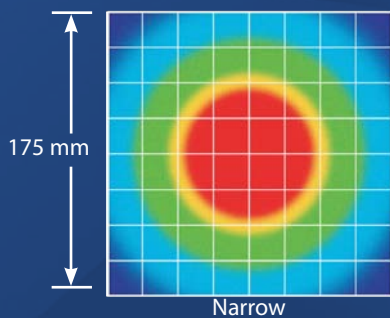

PRODUCT DRAWING

CAD files available on our website.
Dimensions are in mm.

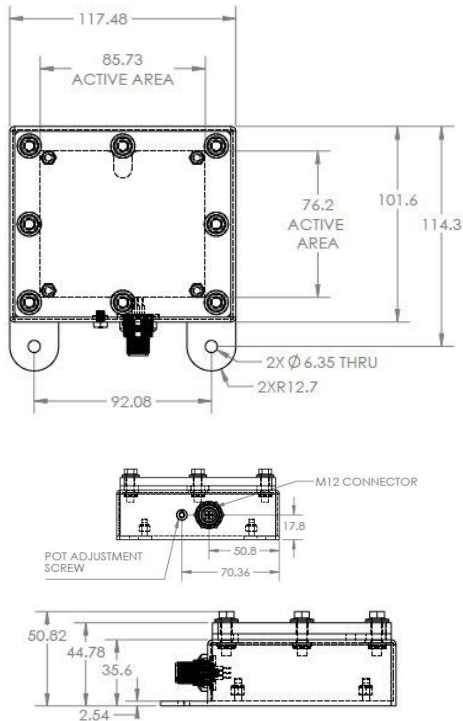

SAFESTROBE™ TECHNOLOGY

SafeStrobe™ technology applies safe working parameters to ensure high-current LEDs are not damaged when driving them beyond their limits, such as maximum strobe time or duty cycle. This unique technology is especially beneficial for overdriving our high-current LEDs.

ILLUMINATION

ODSW75 Series of Brick Lights works best for:

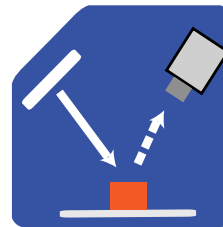

Bright Field

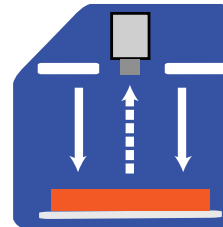

Direct Lighting

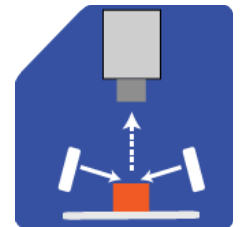

Dark Field

EYE SAFETY

According to IEC 62471: 2006. Full documentation available upon request.



Notice

Exempt Group: No photobiological hazard to eyes or skin even for continuous, unrestricted use. Applicable for wavelengths 625, 850, 940, 1050, 1200, 1300, 1450, and 1550.

Caution

Risk Group 1: Possibly hazardous optical radiation emitted from this product. Do not stare at operating lamp. May be harmful to eyes. Safe for most applications except prolonged exposure. Applicable for wavelengths 470, 505, 530, and WHI.



PART NUMBER

ODSW75 –



COLOR:



LENS:

Leave blank for Standard (Narrow)

W = Wide

L = Line

Part Number Examples:

ODSW75-625 ODSW75, 625 Red Wavelength, Standard (Narrow) Lens

ODSW75-WHI-L ODSW75, White, Line Lens

ODSW75-470-W-LPI ODSW75, 470 Blue Wavelength, Wide Lens, with Linear Polarizer installed

Additional wavelengths and lens options available upon request.



This light is available in our SWIR LEDs.



LENS OPTICS

NARROW (STANDARD)

Narrow 14° angle-cone lenses are standard. Standard lenses create a narrow beam of illumination and are used for long working distances.

WIDE

Wide 30° angle-cone lenses create a large area of illumination. They create a floodlight effect, can be used for short working distances.

LINE

Line, with a 10° width and a 50° fan angle, projects a thin, narrow beam of illumination.

* Additional lens options available upon request.

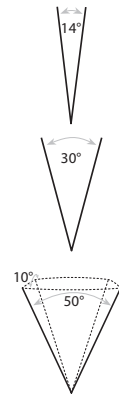

DUTY CYCLE

The Duty Cycle (D) is related to the Strobe Time (ST) and Rest Time (RT).

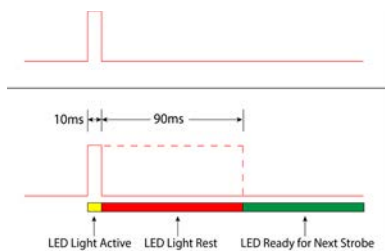

Light follows strobe pulse - the light output will track the width of the strobe pulse.

Calculating Rest Time

$$RT = \frac{ST}{D} - ST$$

RT = Rest Time
ST = Strobe Time
D = Duty Cycle

Example

$$90 \text{ ms} = \frac{10 \text{ ms}}{.1} - 10 \text{ ms}$$

Rest Time is 90 ms for 10 ms Strobe Time

Calculating Strobe Rate

$$SR = \frac{D}{ST}$$

SR = Strobe Rate (strokes per second)
ST = Strobe Time (seconds)
D = Duty Cycle

Example

$$1000 = \frac{0.1}{0.0001}$$

Strobe Rate is 1000 strokes per second

Calculating Duty Cycle

$$D = ST \times SR$$

SR = Strobe Rate (strokes per second)
ST = Strobe Time (seconds)
D = Duty Cycle

Example

$$0.1 = 0.0001 \times 1000$$

Duty Cycle is 10% (0.1)

Maximum Duty Cycle for OverDrive™ light is 10% (0.1)

Note: Strobe time is limited by the strobe rate.



ACCESSORIES

Power Cables	
	
Length	Part Number
5 m	W5PM12-5
10 m	W5PM12-10
15 m	W5PM12-15

Power Cables (Washdown)	
	
Length	Part Number
15 m	W5PM12-15

Washdown cable has a 316 stainless-steel connector.



GLOSSARY

This glossary covers all Smart Vision Lights product families; some content in this section may not apply to this specific light.

TERMINOLOGY

OverDrive™ Light includes an integrated high-current strobe driver for complete LED light control.

Continuous Operation Light stays on continuously.

Multi-Drive™ Combines continuous operation and OverDrive™ strobe (high-current strobe operation) modes into one easy-to-use light.

Built-In Driver The built-in driver allows full function without the need for an external driver.

Camera to Light Connect the light directly to the camera, without the need for additional controllers or equipment.

Polarizers Filters that reduce reflections on specular surfaces.

Diffuser Used to widen the angle of light emission, reduce reflections, and increase uniformity.

TYPES OF ILLUMINATIONS

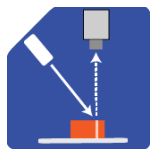

Projector

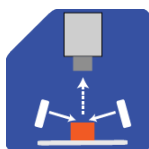

Dark Field

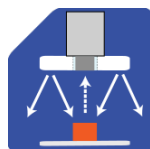

Radial

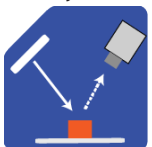

Bright Field

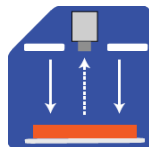

Direct

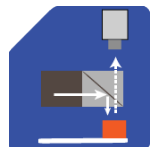

Axial

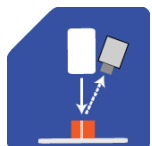

Line

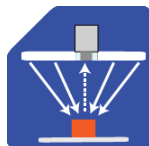

Diffuse Panel

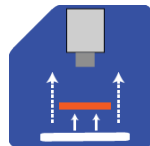

Backlight

COLOR/WAVELENGTHS LEGEND

Wavelength options range from 365 nm to 1550 nm.
Additional wavelengths available for many light families.

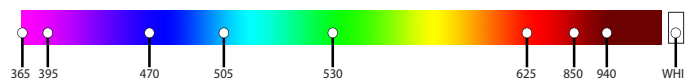

See Part Number section for **this light's** available standard wavelengths.



Shortwave infrared LEDs are available in 1050 nm, 1200 nm, 1300 nm, 1450 nm, and 1550 nm.

Check Part Number section to see if **this light** is available in SWIR wavelengths.