

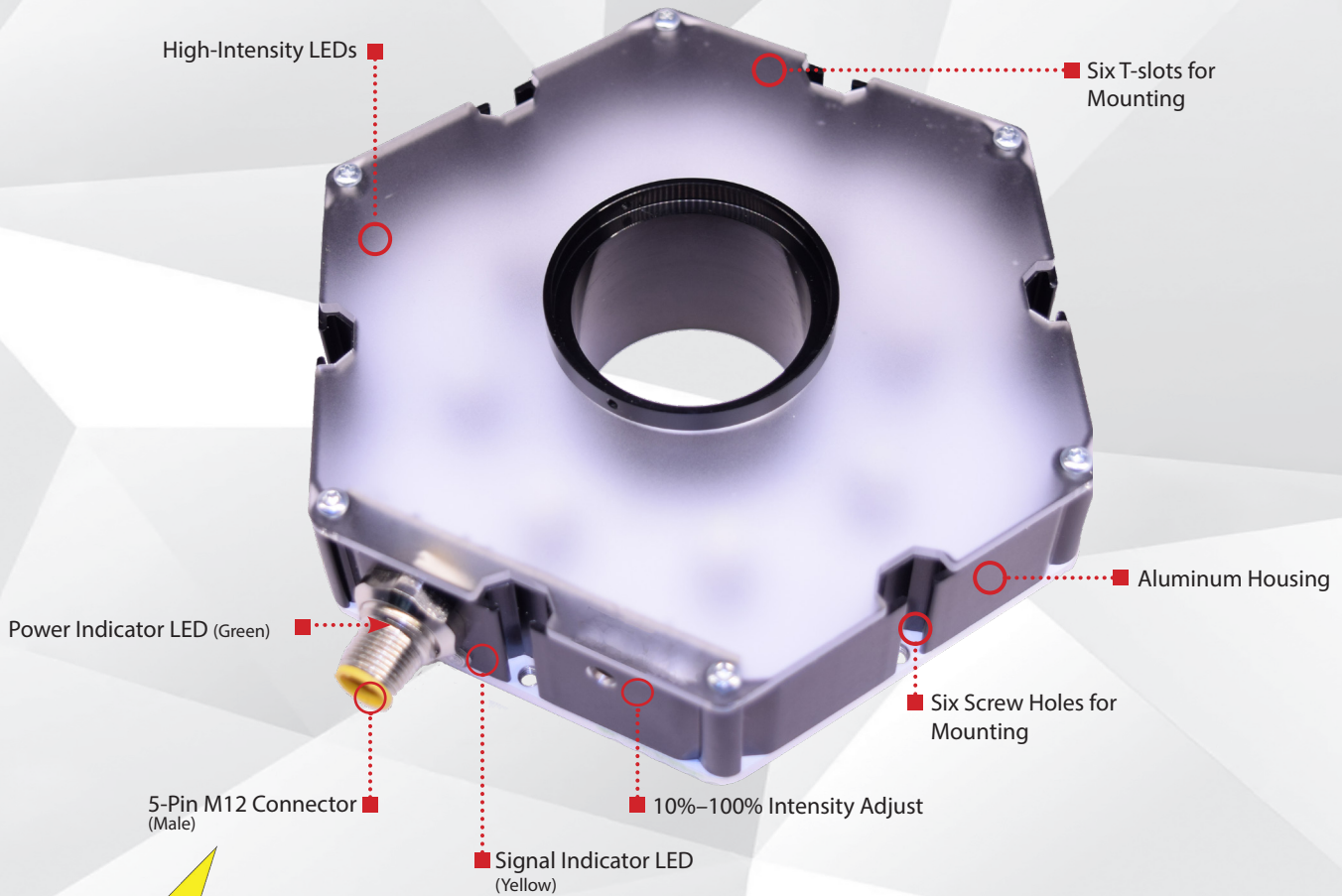

smart  
vision lights

# ODR130-16 EZ Mount RING LIGHT OVERDRIVE™

P R O D U C T D A T A S H E E T



Warranty  
**10**  
YEAR

Compliant  
**IEC**  
62471

Compliant  
**CE**  
RoHS

Rated  
**IP**  
**50**

Connector  
5-PIN  
M12

## PRODUCT HIGHLIGHTS

- ✓ OverDrive™ — Up to five times brighter than a standard EZ Mount Ring Light
- ✓ SafeStrobe™ technology ensures protected operation of LEDs
- ✓ T-slot for mounting
- ✓ Conversion adapters for different cameras
- ✓ 5-pin M12 quick connect
- ✓ Twice the number of LEDs as the ODR130





## PRODUCT INTRODUCTION

The ODR130 is an all-around durable light that also features an OverDrive™ driver with NPN or PNP signal options. Its simple plug-and-play 5-pin M12 connector is easy to use. The 10%–100% intensity control gives users full control over light output. A standard 42 mm inner hole diameter allows for use with nearly all camera systems with available step-up and step-down conversion kit adapters.



## PRODUCT SPECIFICATIONS

Electrical Input	24VDC +/-5%
Input Current	Max. 6.5A draw during strobe — max. average 650 mA
Wattage	Max. 156 W during strobe   max. avg. 15.6 W
Strobe Input	PNP > +4VDC to activate   NPN > GND (<1VDC) to activate
PNP Line	4 mA @ 4VDC   10 mA @ 12VDC   20 mA @ 24VDC
NPN Line	15 mA @ Common (0VDC)
Duty Cycle	Max. 10%
Strobe/Pulse Time	Max. 5000 SPS (strokes per second)   max. single pulse = 125 ms protected
Red Indicator LED	ON = Light Rest (LED inactive)   OFF = LED/Light Ready
Green Indicator LED	ON = Power
Potentiometer	270° turn pot — intensity control of 10%–100%. Turn clockwise to increases intensity.
Analog Intensity	The output is adjustable from 10%–100% of brightness by a 1–10VDC signal.
Connection	5-pin M12 connector
Ambient Temperature	-18°–40°C (0°–104°F)
IP Rating	IP50
Weight	~325 g
Compliances	CE, RoHS, IEC 62471
Warranty	UV LEDs have a 2 year warranty, all other LEDs have a 10 year warranty. For complete warranty information, visit <a href="http://smartvisionlights.com/warranty">smartvisionlights.com/warranty</a> .



## WIRING CONFIGURATION

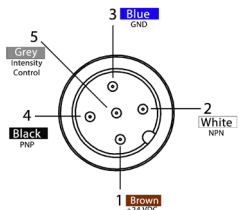

Pin layout for light (Male Connector)

Pin	Function	Signal	Wire Color
1	Power In	+24VDC	BROWN
2	NPN	Sinking Signal	WHITE
3	GND	Ground	BLUE
4	PNP	Sourcing Signal	BLACK
5	Intensity Control	1–10VDC	GREY*

\* Some cables use green/yellow for pin 5

For maximum intensity, tie pin 5 to pin 1 at +24VDC.

For continuous mode: Tie PNP (pin 4) can be tied to +24VDC (pin 1) or tie NPN (pin 2) can be tied to Ground (pin 3).

### NOTICE

If Analog 1–10VDC is not used to control light intensity, analog input must be connected to +VDC (24VDC) — jumper pin 5 to pin 1.



## RESOURCE CORNER

Additional resources, including CAD files, videos, and application examples, are available on our website.



## OPTICAL PERFORMANCE

Smart Vision Lights recommends the ODR130-16 be used at a working distance between 300 mm and 4000 mm.

Beam Diameter (White Light) — 5700K

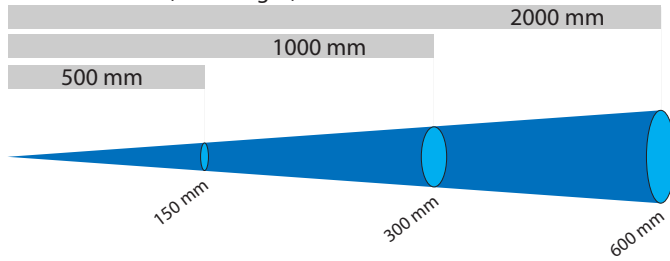

Beam Diameter (White Light) — 5700K

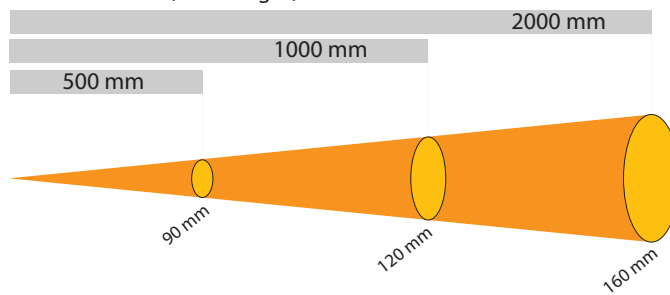

### LIGHTING PATTERN FOR THE ODR130-16-XXX-N

Working Distance mm (inches)	Pattern (80%–100% measured intensity) mm (inches)
500 mm (19.7")	90 mm (~3.5")
1000 mm (39.4")	120 mm (~4.7")
2000 mm (78.8")	160 mm (~6.3")

Typical Output Performance	Illuminance (Lux)
Distance = 500 mm	140,000
<i>Illuminance measurement taken on White Lights — 5700K</i>	

### LIGHTING PATTERN FOR THE ODR130-16-XXX

Working Distance mm (inches)	Pattern (80%–100% measured intensity) mm (inches)
500 mm (19.7")	150 mm (~5.9")
1000 mm (39.4")	300 mm (~11.8")
2000 mm (78.8")	600 mm (~23.6")

Typical Output Performance	Illuminance (Lux)
Distance = 500 mm	110,000
<i>Illuminance measurement taken on White Lights — 5700K</i>	

The ODR130-16 Ring Light produces a uniform light pattern.

Working Distance = 500 mm Grid set to 25 mm x 25 mm

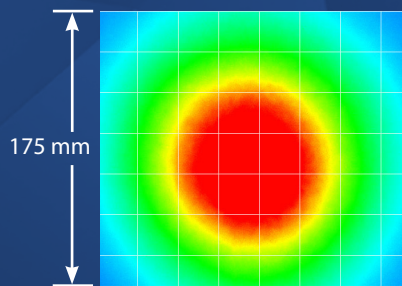

Narrow

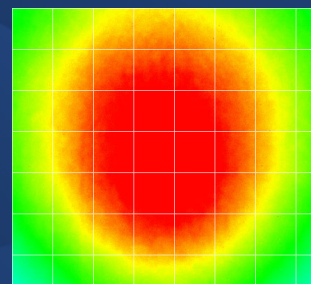

Wide



## PRODUCT DRAWING

CAD files available on our website.  
Dimensions are in mm.

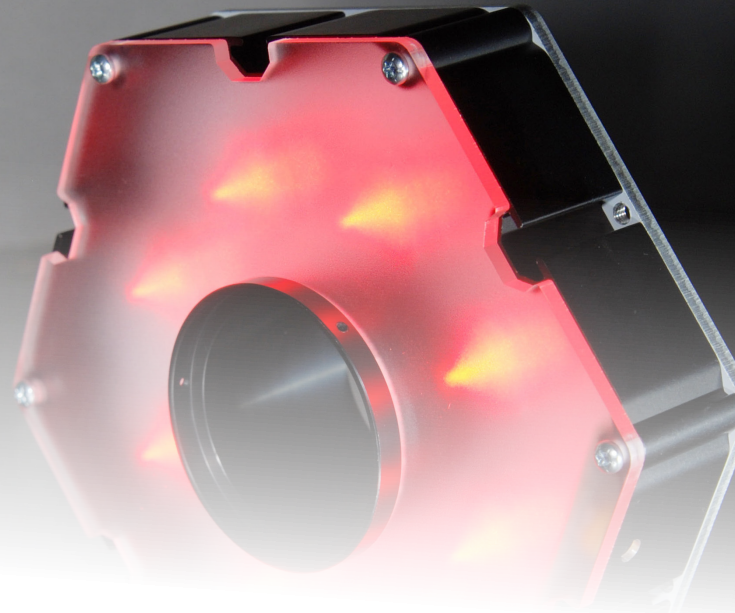
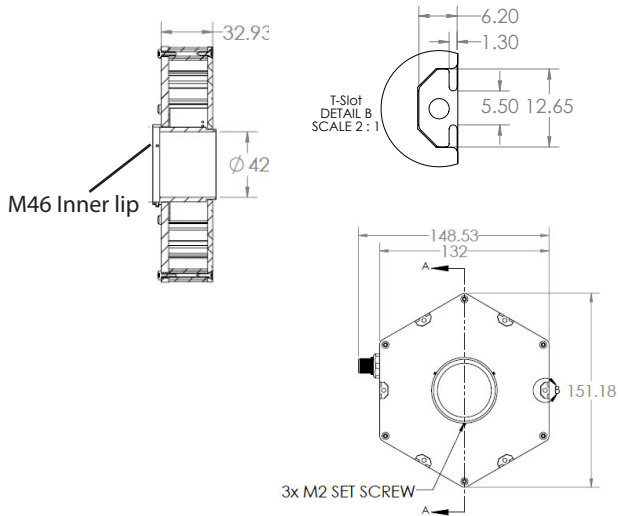
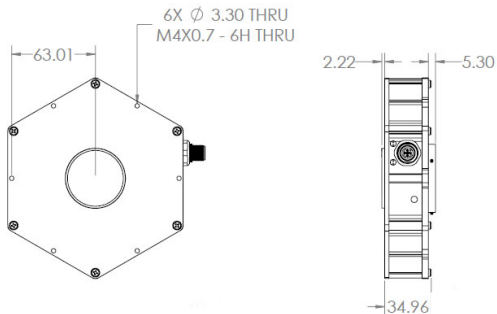

## ILLUMINATION

ODR130-16 Series of Ring Lights works best for:

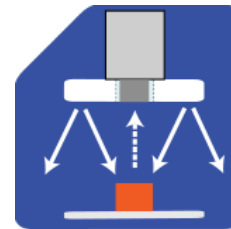

Radial



## EYE SAFETY



According to IEC 62471:2006. Full documentation available upon request.

### Notice

**Exempt Group:** No photobiological hazard to eyes or skin even for continuous, unrestricted use. Applicable for wavelengths 625, 850, and 940.

### Caution

**Risk Group 1:** Possibly hazardous optical radiation emitted from this product. Do not stare at operating lamp. May be harmful to eyes. Safe for most applications except prolonged exposure. Applicable for wavelengths 470, 505, 530, and WHI.

### Notice

**Risk Group 1:** UV emitted from this product. Minimize exposure to eyes and skin. Use appropriate shielding. Safe for most applications except prolonged exposures. Applicable for wavelengths 395.

### Caution

**Risk Group 2:** UV emitted from this product. Eye or skin irritation may result from exposure. Use appropriate shielding. Does not pose optical hazard if aversion responses limit exposure. Applicable for wavelengths 365.





## PART NUMBER

**ODR130-16** –

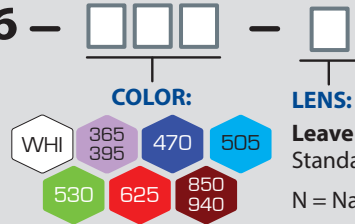

### Part Number Examples:

- ODR130-16-625** ODR130-16, 625 Wavelength, Standard Lens (Wide)
- ODR130-16-WHI-N** ODR130-16, White, Narrow Lens

Additional wavelengths and lens options available upon request.



## LENS OPTICS

### WIDE (STANDARD)

Wide, 30° angle-cone lenses project a large area of illumination. They create a floodlight effect, can be used for short working distances.

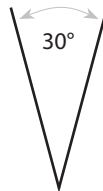

### NARROW

Narrow, 14° angle-cone lenses project a narrow beam of illumination and are used for long working distances.



### When to Use a Linear Polarizer?

Polarizing filters can reduce reflections on specular (Dielectric or nonmetal) surfaces.

A Linear Polarizer has a typical transmission of 38 percent while blocking 62 percent of the light not in the polarization plane.

**WARNING:** Running a light in continuous operation while using a standard polarizer with certain wavelengths (e.g. white, blue) may burn of the polarizer.



## DUTY CYCLE

The Duty Cycle (D) is related to the Strobe Time (ST) and Rest Time (RT).

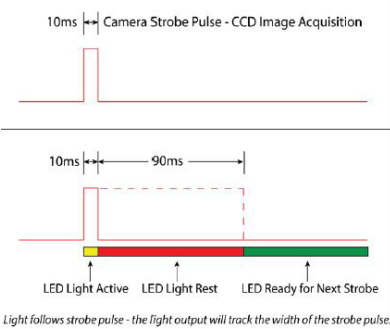

### Calculating Rest Time

$$RT = \frac{ST}{D} - ST$$

RT = Rest Time  
ST = Strobe Time  
D = Duty Cycle

Example

$$90 \text{ ms} = \frac{10 \text{ ms}}{.1} - 10 \text{ ms}$$

Rest Time is 90 ms for 10 ms Strobe Time

### Calculating Strobe Rate

$$SR = \frac{D}{ST}$$

SR = Strobe Rate (strokes per second)  
ST = Strobe Time (seconds)  
D = Duty Cycle

Example

$$1000 = \frac{0.1}{0.0001}$$

Strobe Rate is 1000 strokes per second

### Calculating Duty Cycle

$$D = ST \times SR$$

SR = Strobe Rate (strokes per second)  
ST = Strobe Time (seconds)  
D = Duty Cycle

Example

$$0.1 = 0.0001 \times 1000$$

Duty Cycle is 10% (0.1)



## STEP-UP/STEP-DOWN ADAPTER KITS

Step-Up/Step-Down Adapter Kits allow the M46 thread on ring lights to be mounted directly to the threads found on the front-end of most popular lenses.

Step-Up Adapters allow for mounting a lens that is smaller in diameter to an EZ Mount Ring Light, while Step-Down Adapters allow for mounting a larger lens to an EZ Mount Ring Light.

These kits include: a set of screws and a hex wrench.

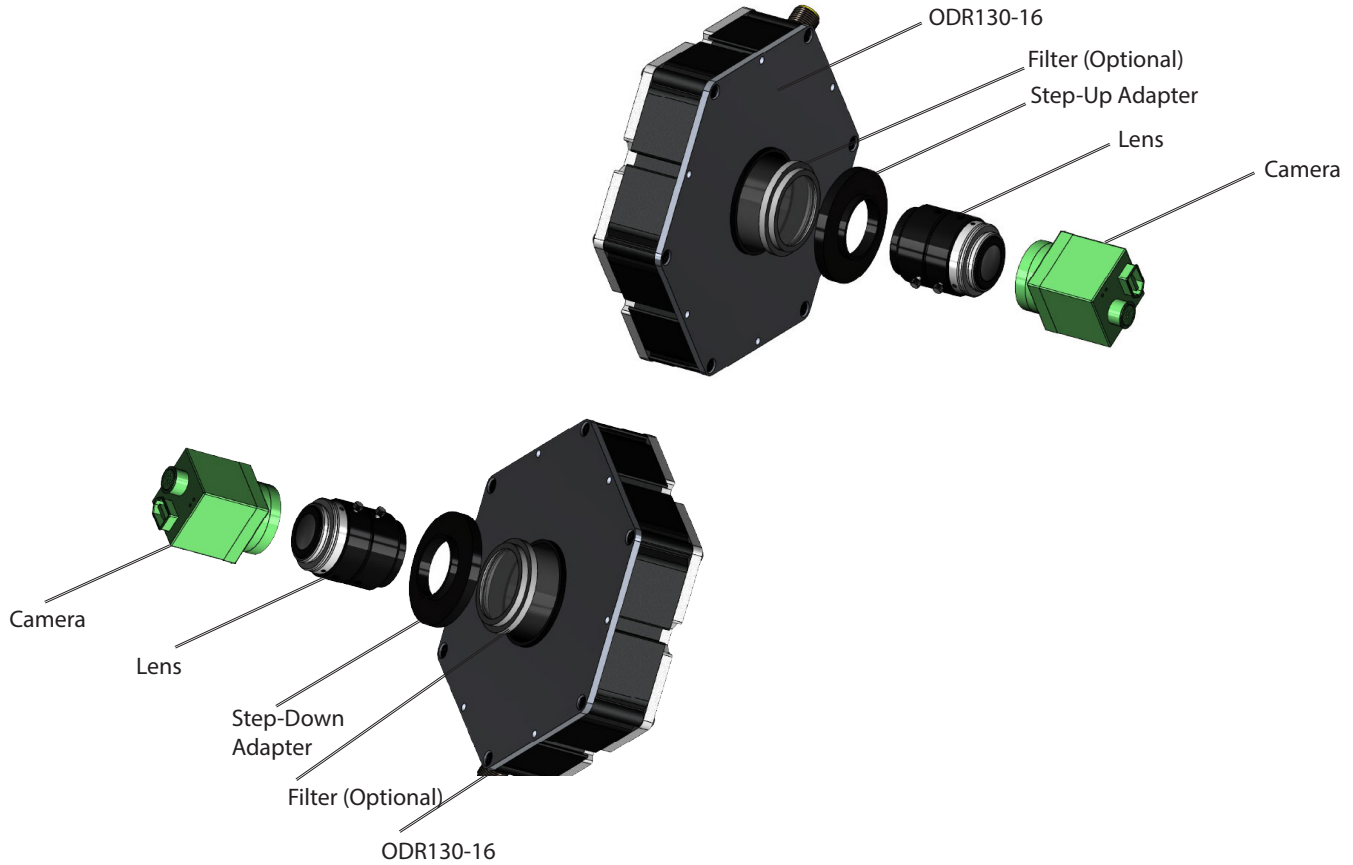

## STEP-UP/STEP-DOWN ADAPTER KITS PART NUMBERS

### STEP-DOWN ADAPTER

SD –   – 46

LENS THREAD SIZE    RING LIGHT THREAD SIZE

49  
52  
55  
58  
62  
67  
72

### STEP-UP ADAPTER

SU –     – 46

LENS THREAD SIZE    RING LIGHT THREAD SIZE

25.5  
27  
30.5  
34  
35.5  
37  
39  
40.5  
43

## CAMERA MOUNTING ADAPTERS

When mounting a camera directly on to an EZ Mount Ring Light, a Double-Female (DF) threaded camera adapter is used.

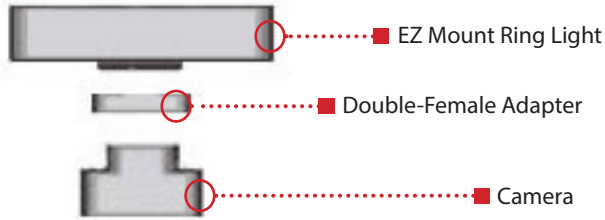

### DOUBLE-FEMALE ADAPTER

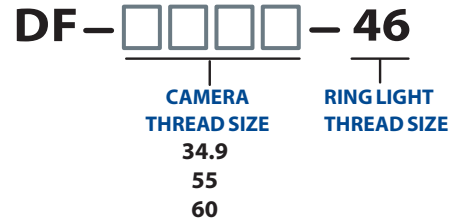

\*When mounting an EZ Mount Ring Light, a double-female adapter is used.

## MOUNTING

Mounting options on the ODR130-16 EZ Mount Ring Light include six T-slots and six M4 threaded holes.

**Optional Mounting Hardware:**

T-slots = M5 x 0.8 mm T-nut

Threaded screw holes = M4 screws

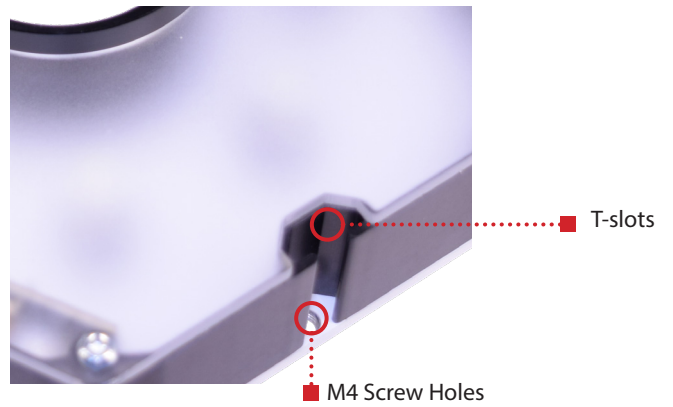

# CAMERA MOUNTING EXAMPLES

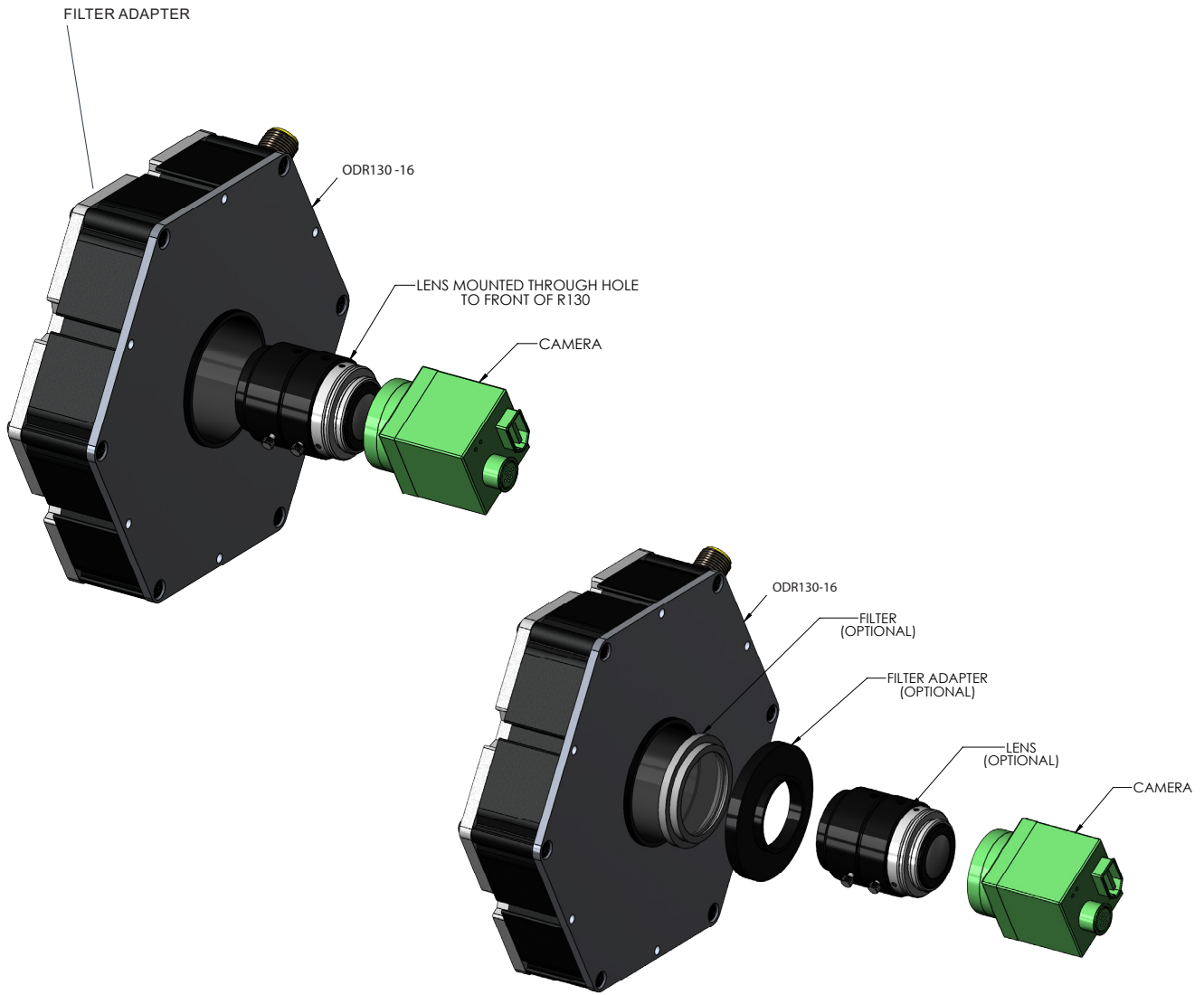





## ACCESSORIES

### Step-Up Kits



Lens Thread Size	Part Number
25.5 mm	SU25.5-46
27 mm	SU27-46
30.5 mm	SU30.5-46
34 mm	SU34-46
35.5 mm	SU35.5-46
37 mm	SU37-46
39 mm	SU39-46
40.5 mm	SU40.5-46
43 mm	SU46-46

### Step-Down Kits



Lens Thread Size	Part Number
49 mm	SD49-46
52 mm	SD52-46
55 mm	SD55-46
58 mm	SD58-46
62 mm	SD62-46
67 mm	SD67-46
72 mm	SD72-46

### Power Cables



Length	Part Number
5 m	5PM12-5
10 m	5PM12-10
15 m	5PM12-15

### Diffuser

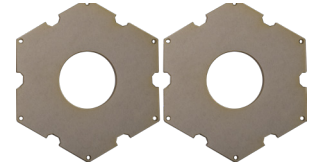

Description	Part Number
Diffuser Kit	R130-16-DKIT

### Camera Adapters



Camera Thread Size	Part Number
55 mm	DF55-46
60 mm	DF60-46
34.5 mm	DF34.5-46

### Camera Mounting Adapter



Description	Part Number
Adapter	BKT0030-KIT

### Linear Polarizer

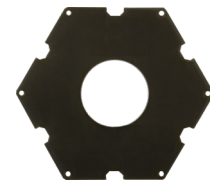

Description	Part Number
Linear Polarizer Kit	R130-16-LP



## GLOSSARY

This glossary covers all Smart Vision Lights product families; some content in this section may not apply to this specific light.

### TERMINOLOGY

**OverDrive™** Light includes an integrated high-pulse driver for complete LED light control.

**Continuous Operation** Light stays on continuously.

**Multi-Drive™** Combines continuous operation and OverDrive™ strobe (high-pulse operation) mode into one easy-to-use light.

**Built-In Driver** The built-in driver allows full function without the need for an external controller.

**Camera to Light** Connect the light directly to the camera, without the need for additional controllers or equipment.

**Polarizers** Filters that reduce reflections on specular surfaces.

**Diffusers** Used to widen the angle of light emission, reduce reflections, and increase uniformity.

### TYPES OF ILLUMINATIONS

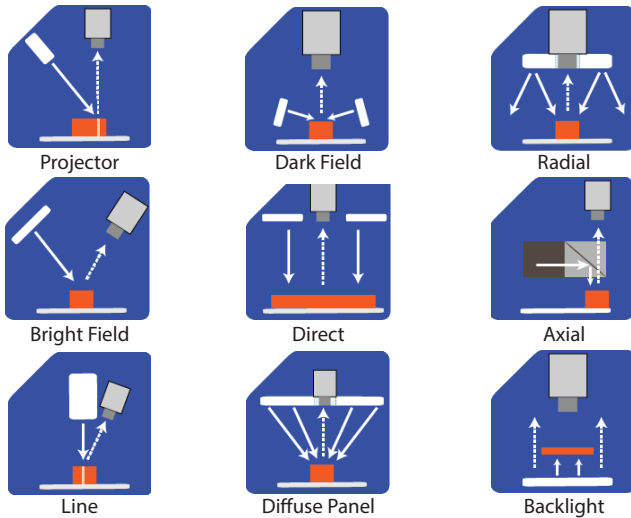

### COLOR/WAVELENGTHS LEGEND

Wavelength options range from 365 nm to 1550 nm.\*  
Additional wavelengths available for many light families.

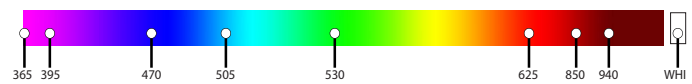

\*See Part Number section for **this light's** available standard wavelengths.



Shortwave infrared LEDs are available in 1050 nm, 1200 nm, 1300 nm, 1450 nm, and 1550 nm.\*

\*Check Part Number section to see if **this light** is available in SWIR wavelengths.