

Instruction Guide



Thank you for purchasing a CCS product. To ensure proper use of the product, please read this instruction guide before use and keep it for your future reference.

1 Important Information for Equipment Safety - Read Before Use -

This product has been designed with full consideration of safety. However, incorrect usage of the product may result in fire, electric shock, or other serious damages. Please ensure to follow the conditions below.

The following symbols are used in this instruction guide to indicate and classify the relative importance of warnings and cautions.

	Warning	Indicates that incorrect usage may result in serious injury or death.		Caution	Indicates that incorrect usage may result in injury or property damage.
--	----------------	-----------------------------------------------------------------------	--	----------------	-------------------------------------------------------------------------

The following symbols in the instruction guide indicate and classify the precautions.

	PROHIBITED		INSTRUCTED
	DISASSEMBLY PROHIBITED		
	DO NOT TOUCH WITH WET HANDS		
	DO NOT SUBJECT TO MOISTURE		
These symbols mean the prohibited action.		These symbols mean the necessary action must obey.	

		Warning	
Do not disassemble or modify the product. Doing so may result in fire or electric shock.		LED Light radiation may cause corneal or retinal abnormalities if you look directly at the light. To prevent harmful light exposure, never look directly at the LED Light.	
Do not touch the product with wet hands. Doing so may result in electric shock.		This product generates high temperatures. Do not touch the product while it is turned on or immediately after it is turned off, or burning may result. Provide cooling with a fan or other ventilation if the product is to be used in a closed space.	
Make sure that the product is free of moisture or any liquid. Exposure to water may result in fire or electric shock.		If abnormal condition occurs such as fuming, heat, smell, noise, or so on, stop using the product immediately, turn the power off, and unplug the power cord. A fire or electric shock may result if the product is kept used.	
Connect or disconnect the light cable only after turning off the Control Unit for the LED Light. Failure to do so may result in circuit damage, fire caused by a minute spark, or electric shock.			

		Caution	
Do not use user-made cables. Doing so may cause product failure. Use the CCS extension cable if it is necessary to extend the distance between the light and the Control Unit.		Use a Control Unit that is suitable for the product ratings. Using an incorrect Control Unit can cause product failure.	
Be careful of static electricity. Damage to the LED Light may occur, if a person charged with static electricity touches it. Keep the product away from all items charged with static electricity.		Make sure that the length of the extension cable is less than 5 m. If the extension cable is longer than 5 m, the voltage applied to both ends of the LED Light will drop due to the DC resistance of the cable. The rated voltage will not be attained for 100% radiant ability, and the radiant quantity will drop as a result.	
Do not drop the product or subject it to impact. Doing so may cause the product to malfunction.			

Do not use the product in the following situations.

- Under conditions or in an environment not described in this instruction guide.
- In nuclear energy control systems, railroad systems, aviation systems, vehicles, combustion equipment, medical equipment, amusement machines, or safety equipment.
- In applications involving serious risk to life or property, particularly applications demanding a high level of safety.

Please install the product to locations with following conditions. Incorrect installation location may cause product failure.

- In a stable location with minimal vibration.
- Places free from any water, oil, liquid, chemical, or steam.
- Well-ventilated places with minimal dust.
- Places free from corrosive or combustible gas.
- Places that are not subject to sudden temperature changes.
- Places away from water faucets, boilers, humidifiers, air conditioners, heaters, or stoves.

2 Confirming Product Information

The following tag is attached to the cable on the LED Light. The color of the label indicates the luminescence color of the Light. The back of the tag there is a name label that gives the model number, power consumption, and serial number. Be sure to check the contents before using the product and handle the label with care. If the label is missing or damaged and the contents cannot be checked, please contact CCS Inc.

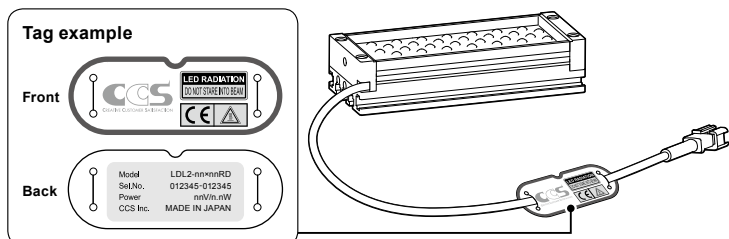

3 Installation

Installation on a Frame

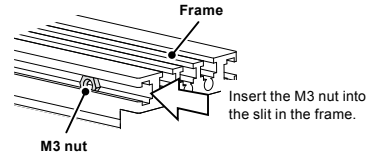
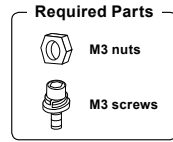

Side Installation

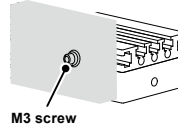

Rear Installation

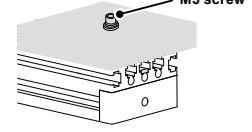

Installation Using a Tap Hole

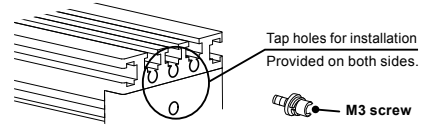

Direct Installation

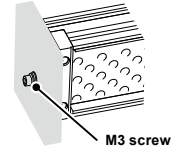

Installation with Brackets

Brackets (Optional product)

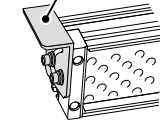

Reference!
Read *LDL2 series Operation Guide for Optional Products* before using optional products.

Caution The tap holes on the back surface are for factory use. Do not use them for installation.

4 Operating Instructions

Wire Connection

- Make sure that the power is turned OFF.
- Connect the light cable of the Light Unit to the Control Unit output connector.

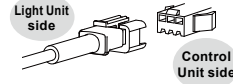

Insert the connector completely.

Reference!
Read the instruction guide of the Control Unit for the LED Light before use.

Capture Images

- Turn the power on.
- The Light will come on.

Preparations!
Focus imaging devices such as cameras, microscopes, etc. to inspection objects.

Adjustment!
Adjust light range, light angle, and radiant quantity to optimize images. Use the Control Unit to adjust the radiant quantity.

Reference!
Read *LDL2 series Operation Guide for Optional Products* before using optional products.

Lighting at a Fixed Angle

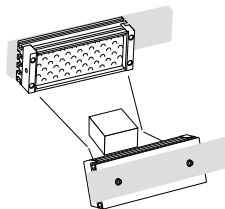

Backlight Lighting Using a Diffusion Plate

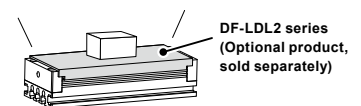

Diffusion plates, polarizing plates, and protective plates cannot be stacked for installation or used together.

Lighting When Using the Brackets (BK-LDL2)

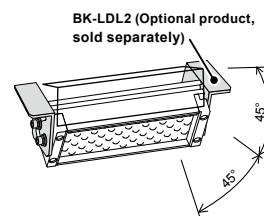

The lighting angle is adjustable.

Lighting When Using the Brackets (BK-LDQ2 series)

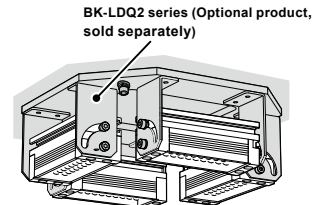

The lighting angle is adjustable.

Common Specifications

Input voltage	24 VDC
Peak wavelength/ Correlated color temperature (typ.)	White: 6600 K (LDL2-nn×nnSW-NR: 7000K) Red: 635 nm Blue: 470 nm Green: 525 nm
Connector	SMR-03V-B
Polarity, signal	1: (+) 2: NC 3: (-)
Cable length	300 mm
Cooling method	Natural air-cooling
Operating environment (indoors only)	Temperature: 0 to 40°C, Humidity: 20 to 85%RH (with no condensation)
Storage Environment	Temperature: -20 to 60°C, Humidity: 20 to 85%RH (with no condensation)
CE Marking	Safety standard: EN 62471 compliant
Environmental regulations	RoHS compliant
Case material	Aluminum alloy
Accessories	Instruction Guide x1

Specifications by Model

Model name*	LED color	Power consumption (max.)	Weight (max.)	Model name*	LED color	Power consumption (max.)	Weight (max.)
LDL2-41×16RD	Red	1.9 W	50 g	LDL2-74×30RD	Red	5.7 W	100 g
LDL2-41×16SW	White			LDL2-74×30SW	White		
LDL2-41×16BL	Blue			LDL2-74×30BL	Blue		
LDL2-41×16GR	Green	3.8 W	75 g	LDL2-74×30GR	Green	12 W	170 g
LDL2-80×16RD	Red			LDL2-146×30RD	Red		
LDL2-80×16SW	White			LDL2-146×30SW	White		
LDL2-80×16BL	Blue	5.7 W	95 g	LDL2-146×30BL	Blue	18 W	240 g
LDL2-80×16GR	Green			LDL2-146×30GR	Green		
LDL2-119×16RD	Red			LDL2-218×30RD	Red		
LDL2-119×16SW	White	21 W	280 g	LDL2-218×30SW	White	21 W	280 g
LDL2-119×16BL	Blue			LDL2-218×30BL	Blue		
LDL2-119×16GR	Green			LDL2-218×30GR	Green		
				LDL2-266×30RD	Red	21 W	280 g
				LDL2-266×30SW	White		
				LDL2-266×30BL	Blue		
				LDL2-266×30GR	Green		

* These are the names of narrow types. "-NR" is added at the end of the name of the white LED Light whose correlated color temperature is 7000 K. In the case of wide type, add "-WD" at the end of the name. In most cases unless otherwise specified, the descriptions on this Instruction Guide are commonly applicable for all models.

EU RoHS Directive

The RoHS Directive is short for the "restriction of use of certain hazardous substances in electrical and electronic equipment." As a directive, it restricts the use of specific hazardous substances for new electrical and electronic equipment marketed in the EU on or after July 1, 2006, and restricts the use of six substances, which are (1) lead, (2) mercury, (3) cadmium, (4) hexavalent chromium, (5) polybrominated biphenyl (PBB), and (6) polybrominated diphenyl ether (PBDE).

*Standards for "RoHS Directive-Compliant Products"

Lead	Mercury	Cadmium	Hexavalent chromium	PBB	PBDE
1000ppm max.	1000ppm max.	100ppm max.	1000ppm max.	1000ppm max.	1000ppm max.

(Items that are exempted in the RoHS Directive are excluded from these standards.)

China RoHS Directive

China RoHS Directive is formally known as "Management Methods for Controlling Pollution by Electronic Information Products", which was implemented on March 1, 2007 in China. Same as EU RoHS Directive, this regulation restricts the usage of six substances such as lead, mercury, cadmium, hexavalent chromium, polybrominated biphenyl (PBB), and polybrominated diphenyl ether (PBDE). This regulation requires electronic information products which are manufactured or imported, and sold in China, to clearly disclose contents of the 6 restricted substances listed below.

Usage Deadline for Environmental Protection	Product name	Toxic or Hazardous Substances and Elements					
		Lead (Pb)	Mercury (Hg)	Cadmium (Cd)	Hexavalent chromium (Cr(VI))	PBB	PBDE
10	LED Lights	×	○	×	○	○	○

○: Indicates that this toxic or hazardous substances contained in all the homogeneous materials for this part, according to SJ/T11363-2006 is within the limit requirement.
 ×: Indicates that this toxic or hazardous substance contained in all the homogeneous materials for this part, according to SJ/T11363-2006, is over the limit requirement.
 *Lead and cadmium are excluded in EU RoHS.

Usage deadline for environmental protection
 The number used in this logo is based on "Management Methods for Controlling Pollution by Electronic Information Products" and related regulations under People's Republic of China. It shows the product usage duration in years for environmental protection. After finishing a product usage, the product needs to be re-used or discarded appropriately following local law and regulations, complying with safety and usage caution.

环保使用期限	产品	产品中有毒有害物质或元素的名称及含量					
		铅 (Pb)	汞 (Hg)	镉 (Cd)	六价铬 (Cr(VI))	多溴联苯 (PBB)	多溴二苯醚 (PBDE)
10	LED 照明	×	○	×	○	○	○

○: 表示该有毒有害物质在该部件所有均质材料中的含量均在 SJ/T11363-2006 标准规定的限量要求以下。
 ×: 表示该有毒有害物质至少在该部件的某一均质材料中的含量超出 SJ/T11363-2006 标准规定的限量要求。
 (注) 铅和镉中的 "×", 因欧洲 RoHS 没限定, 故用 "○" 表示。

环保使用期限
 此标志的数字是根据中华人民共和国电子产品污染控制管理办法以及有关标准等, 表示该产品的环保使用期限的年限。遵守产品的安全和使用上的注意, 在产品使用后采取适当的方法根据各地法律, 规定, 回收再利用或进行废弃处理。

LDL2-n×16RD/SW/BL/GR
 (Common for all SW-NR, -WD models.)

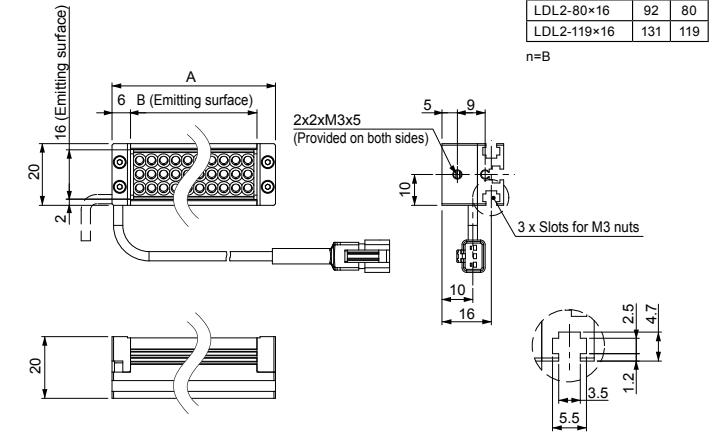

LDL2-n×30RD/SW/BL/GR
 (Common for all SW-NR, -WD models.)

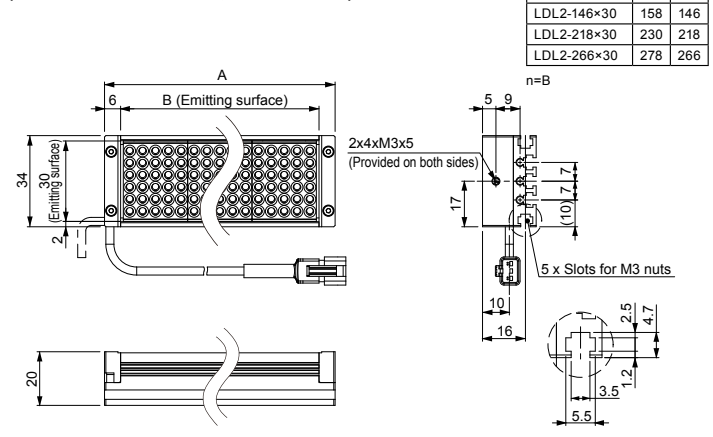

Note: For the specifications of the products which are not shown above, refer to the catalog.

Warranty Information

EXCEPT FOR THE EXPRESS WARRANTIES STATED IN THIS DOCUMENT, CCS MAKES NO ADDITIONAL WARRANTIES, EXPRESS, IMPLIED, OR STATUTORY, AS TO ANY MATTER WHATSOEVER. IN PARTICULAR, ANY AND ALL WARRANTIES OF MERCHANTABILITY OR FITNESS FOR PARTICULAR PURPOSE ARE EXPRESSLY EXCLUDED. EXCEPT AS EXPRESSLY SET FORTH HEREIN, CCS MAKES NO WARRANTIES WITH RESPECT TO THE PRODUCTS.

WARRANTY PERIOD: TWO YEARS (ONE YEAR FOR RADIANT QUANTITY), STARTING FROM CCS Inc. SHIPPING DATE.

CCS Inc. WILL REPAIR OR REPLACE THE PRODUCT FREE OF CHARGE IF IT SHOULD FAIL TO FUNCTION OR IF THE RADIANT QUANTITY OF THE PRODUCT SHOULD DROP TO 50% OR LESS OF ITS INITIAL RADIANT QUANTITY WITHIN THE SPECIFIED WARRANTY PERIOD. IF EITHER OF THESE CONDITIONS OCCURS, PLEASE TAKE THE PRODUCT TO YOUR CCS SALES REPRESENTATIVE.

WARRANTY TERMS

- CCS Inc. WILL REPAIR OR REPLACE THE PRODUCT FREE OF CHARGE IF IT SHOULD FAIL TO FUNCTION UNDER USE ON OUR SPECIFIED CONDITION IN ACCORDANCE WITH THE INSTRUCTION GUIDE AND OTHER WRITTEN CAUTIONS DURING THE INDICATED WARRANTY PERIOD OF TWO YEARS.
- CCS Inc. WILL REPAIR OR REPLACE THE PRODUCT FREE OF CHARGE IF ITS RADIANT QUANTITY SHOULD DROP TO 50% OR LESS OF ITS INITIAL RADIANT QUANTITY UNDER USE ON OUR SPECIFIED CONDITION IN ACCORDANCE WITH THE INSTRUCTION GUIDE AND OTHER WRITTEN CAUTIONS DURING THE INDICATED WARRANTY PERIOD OF ONE YEAR.
- CCS Inc. WILL CHARGE A REPAIR FEE UNDER THE FOLLOWING CONDITIONS:
 - IF THE PRODUCT HAS BEEN SUBJECTED TO MISUSE, UNAUTHORIZED REPAIRS, OR MODIFICATION FROM ITS ORIGINAL DESIGN.
 - IF THE PRODUCT HAS BEEN DAMAGED FROM IMPACTS DUE TO INAPPROPRIATE HANDLING.
 - IF DAMAGE TO THE PRODUCT RESULTS FROM EXTERNAL CAUSES INCLUDING ACCIDENTS, FIRE, POLLUTION, RIOTS, COMMUNICATION FAILURES, EARTHQUAKES, THUNDERSTORMS, WIND AND FLOOD DAMAGE, OR ANY OTHER ACT OF PROVIDENCE, OR FROM ANY EXTRAORDINARY CONDITIONS SUCH AS ELECTRICAL SURGES, WATER LEAKAGE, CONDENSATION, OR THE USE OF CHEMICALS.
 - IF THE DAMAGE RESULTS FROM CONNECTION TO ANY POWER SUPPLY OR TO ANY EQUIPMENT WHICH CCS Inc. DOES NOT MANUFACTURE OR DOES NOT SPECIFY FOR USE.
- CCS ASSUMES NO LIABILITY FOR ANY PURCHASER'S SECONDARY DAMAGE (DAMAGE OF EQUIPMENT, LOSS OF OPPORTUNITIES, LOSS OF PROFITS, ETC.) OR ANY OTHER DAMAGE RESULTING FROM A FAILURE OF OUR PRODUCT.

THIS WARRANTY INFORMATION PROVIDES THE SCOPE OF CCS'S PRODUCT WARRANTY WITHIN THE SPECIFIED PERIOD, AND DOES NOT INDICATE OR IMPLY ANY FURTHER GUARANTEE BEYOND THE WARRANTY TERMS.

CONTACT CCS FOR INQUIRIES OR INFORMATION ON REPAIRS TO THE PRODUCT AFTER THE EXPIRATION OF THE WARRANTY.

NOTE: THE RADIANT QUANTITY REFERS TO THE WATTAGE OF PHYSICAL ENERGY RADIATED FROM AN LED. IT REFERS TO THE RADIATION LUMINOSITY OF THE LED MEASURED UNDER CONDITIONS SPECIFIED BY CCS OR THE RADIATION ILLUMINATION OF THE LED UNDER SPECIFIED IRRADIATION CONDITIONS. CCS SPECIFIES THE RADIANT QUANTITY FOR EACH LED LIGHT BECAUSE THE MEASUREMENT AND IRRADIATION CONDITIONS VARY FROM THE FORM, THE APPLICATION AND THE IRRADIATION WAVELENGTH.

- Contents of this Instruction Guide may be changed without prior notice.
- Illustrations used in this Instruction Guide may differ from actual products.
- CCS maintains the copyright on this Instruction Guide. Unauthorized transfer or reproduction is strictly prohibited.

Instruction Guide and Dimensional Diagrams in PDF or CAD can be downloaded from the CCS website. <http://www.ccs-grp.com>

Ask any product queries to the following address or to your nearest CCS representative.



Headquarters Shimodachiuri-agaru, Karasuma-dori, Kamigyo-ku, Kyoto 602-8011 Japan
 Phone : +81-75-415-8284 Fax : +81-75-415-8278 E-mail : intlsales@ccs-inc.co.jp
 Use our website to find your nearest CCS representative. <http://www.ccs-grp.com/mvad>